

56

Thorax
Thorax
Thorax
Tórax
Torace

Rippenscheren
Rib Shears
Costotomes
Costótomos
Costotomi

dimeda[®]

SURGICAL INSTRUMENTS



56.102.23
23,0 cm



56.105.22
22,0 cm

Rippenschere mit ziehendem Schnitt
Rib shears with drawing cut
Costotome avec lame excentrée
Costótomo con hoja de retroacción
Costotomo con lama eccentrica a scorrimento



GLUCK
56.107.22
22,0 cm



STILLE
56.111.21
21,0 cm



CORYLLOS
56.125.35
35,0 cm

CORYLLOS
56.123.35
35,0 cm



BETHUNE
56.126.34
34,0 cm



COOLEY
56.128.35
35,0 cm



SAUERBRUCH
56.131.26
26,0 cm

für die erste Rippe
for the first rib
pour la première côte
para la primera costilla
per la prima costola



GIERTZ-STILLE
56.137.27
27,0 cm



SAUERBRUCH-FREY
56.141.36
36,0 cm



BRUNNER
56.147.28
32,0 cm

für die rechte Hand
for right hand
pour la main droite
para la mano derecha
per la mano destra

BRUNNER
56.149.28
32,0 cm

für die linke Hand
for left hand
pour la main gauche
para la mano
izquierda
per la mano sinistra

Sternum Schere
Sternum scissors
Ciseaux a sternum
Tijera de esternón
Forbici per sterno



SCHUMACHER
56.148.21
21,0 cm

Blatt · Blade · valve · hoja · valva		
Spreizung Spread	Tiefe Depth	Breite Width
Ecartement	profondité	largeur
Abertura	profundidad	ancho
Apertura	profondità	larghezza
A	B	C



FINOCHIETTO

	A = mm	B = mm	C = mm
56.210.16	165 mm	40 mm	40 mm
56.210.20	200 mm	45 mm	65 mm
56.210.25	250 mm	70 mm	65 mm
56.210.30	300 mm	70 mm	65 mm

für Erwachsene · for adults · pour adultes · para adultos · per adulti

ALUMINIUM



FINOCHIETTO (modif.)

	A = mm	B = mm	C = mm
56.212.12	120 mm	14 mm	15 mm

für Kinder · for children · pour enfants · para niños · per bambini

Blatt · Blade · valve · hoja · valva		
Spreizung Spread Ecartement Abertura Apertura	Tiefe Depth profondité profundidad profondità	Breite Width largeur ancho larghezza
A	B	C



FINOCHIETTO-BABY

	A = mm	B = mm	C = mm
56.214.75	75 mm	18 mm	20 mm

für Säuglinge · for babies · pour bébé · para bebés · per neonati

ALUMINIUM



COOLEY

	A = mm	B = mm	C = mm
56.220.01	95 mm	12 mm	13 mm

für Säuglinge · for babies · pour bébé · para bebés · per neonati

COOLEY

	A = mm	B = mm	C = mm
56.220.02	140 mm	15 mm	30 mm
56.220.03	150 mm	21 mm	44 mm

für Kinder · for children · pour enfants · para niños · per bambini

COOLEY

	A = mm	B = mm	C = mm
56.220.04	200 mm	35 mm	50 mm

für Erwachsene · for adults · pour adultes · para adultos · per adulti

Blatt · Blade · valve · hoja · valva		
Spreizung Spread Ecartement Abertura Apertura	Tiefe Depth profondité profundidad profondità	Breite Width largeur ancho larghezza
A	B	C

ALUMINIUM



FINOCHIETTO

	A = mm	B = mm	C = mm
56.230.13	135 mm	38 mm	44 mm
56.230.17	175 mm	52 mm	62 mm
56.230.18	175 mm	85 mm	65 mm

für Erwachsene · for adults · pour adultes · para adultos · per adulti

ALUMINIUM



FINOCHIETTO HAIGHT Baby

	A = mm	B = mm	C = mm
56.232.10	100 mm	31 mm	31 mm

für Kinder · for children · pour enfants · para niños · per bambini

Blatt · Blade · valve · hoja · valva		
Spreizung Spread Ecartement Abertura Apertura	Tiefe Depth profondité profundidad profondità	Breite Width largeur ancho larghezza
A	B	C

ALUMINIUM



FINOCHIETTO

	A = mm	B = mm	C = mm
56.234.40	100 mm	12 mm	15 mm
56.234.41	143 mm	28 mm	30 mm
56.234.42	210 mm	31 mm	45 mm
56.234.43	245 mm	42 mm	61 mm
56.234.44	245 mm	74 mm	64 mm

für Erwachsene · for adults · pour adultes · para adultos · per adulti

Blatt · Blade · valve · hoja · valva		
Spreizung Spread Ecartement Abertura Apertura	Tiefe Depth profondité profundidad profondità	Breite Width largeur ancho larghezza
A	B	C

ALUMINIUM



FINOCHIETTO Infant

	A = mm	B = mm	C = mm
56.234.75	75 mm	15 mm	15 mm

für Säuglinge · for babies · pour bébé · para bebés · per neonati



mit 2 Paar Valven
 with 2 pairs of blades
 avec 2 paires de valves
 con 2 pares de valvas
 con 2 paia di valve

FINOCHIETTO BURFORD

	A = mm	B = mm	C = mm
56.236.21	210 mm	48/77 mm	64 mm
56.236.25	260 mm	48/77 mm	64 mm
56.236.30	300 mm	48/77 mm	64 mm

für Erwachsene · for adults · pour adultes · para adultos · per adulti

Blatt · Blade · valve · hoja · valva		
Spreizung Spread	Tiefe Depth	Breite Width
Ecartement	profondité	largeur
Abertura	profundidad	ancho
Apertura	profondità	larghezza
A	B	C



ALUMINIUM

mit 2 Paar Valven
 with 2 pairs of blades
 avec 2 paires de valves
 con 2 pares de valvas
 con 2 paia di valve

FINOCHIETTO BURFORD

	A = mm	B = mm	C = mm
56.242.18	180 mm	47/65 mm	62 mm
56.242.26	260 mm	47/65 mm	62 mm
56.242.30	300 mm	47/65 mm	62 mm

für Erwachsene · for adults · pour adultes · para adultos · per adulti



ALUMINIUM

Blatt · Blade · valve · hoja · valva		
Spreizung Spread Ecartement Abertura Apertura	Tiefe Depth profondité profundidad profondità	Breite Width largeur ancho larghezza
A	B	C

mit 2 Paar Valven
 with 2 pairs of blades
 avec 2 paires de valves
 con 2 pares de valvas
 con 2 paia di valve

FINOCHIETTO BURFORD

	A = mm	B = mm	C = mm
56.244.13	135 mm	34/48 mm	42 mm

für Kinder · for children · pour enfants · para niños · per bambini



ALUMINIUM

CASTAÑEDA

	A = mm	B = mm	C = mm
56.250.06	65 mm	10,5 mm	32 mm

für Säuglinge · for babies · pour bébé · para bebés · per neonati

CASTAÑEDA

	A = mm	B = mm	C = mm
56.250.07	70 mm	12 mm	45 mm

für Kinder · for children · pour enfants · para niños · per bambini

CASTAÑEDA

	A = mm	B = mm	C = mm
56.250.12	120 mm	15 mm	60 mm

für Kinder · for children · pour enfants · para niños · per bambini

Blatt · Blade · valve · hoja · valva		
Spreizung Spread	Tiefe Depth	Breite Width
Ecartement	profondité	largeur
Abertura	profundidad	ancho
Apertura	profondità	larghezza
A	B	C



CHEVALIER

	A = mm	B = mm	C = mm
56.259.19	190 mm	27 mm	100 mm



HAIGHT

	A = mm	B = mm	C = mm
56.260.09	90 mm	30 mm	30 mm
56.260.15	115 mm	30 mm	30 mm

Blatt · Blade · valve · hoja · valva		
Spreizung Spread Ecartement Abertura Apertura	Tiefe Depth profondité profundidad profondità	Breite Width largeur ancho larghezza
A	B	C



TUFFIER

	A = mm	B = mm	C = mm
56.264.16	165 mm	50 mm	45 mm



Thoraxsperrer
 Thoracic retractor
 Ecarteur thoracique
 Separador torácico
 Divaricatore per il torace



MERCEDES
56.270.00

Thoraxsperrer, komplett, bestehend aus:
56.270.10 1 Sperrer
56.270.48 2 Seitenvlaven 42 x 65 mm
56.270.70 2 Seitenvlaven 75 x 75 mm

Thoracic retractor, complete, consisting of:
56.270.10 1 Spreader
56.270.48 2 Lateral blades 42 x 65 mm
56.270.70 2 Lateral blades 75 x 75 mm

Ecarteur thoracique, complet, compuesto de:
56.270.10 1 Ecarteur
56.270.48 2 Valves latérales 42 x 65 mm
56.270.70 2 Valves latérales 75 x 75 mm

Separador torácico, completo, compuesto de:
56.270.10 1 Separador
56.270.48 2 Valvas laterales 42 x 65 mm
56.270.70 2 Valvas laterales 75 x 75 mm

Divaricatore per il torace, completo, composto da:
56.270.10 1 Divaricatore
56.270.48 2 Valve laterali 42 x 65 mm
56.270.70 2 Valve laterali 75 x 75 mm

Blatt · Blade · valve · hoja · valva		
Spreizung Spread	Tiefe Depth	Breite Width
Ecartement	profondité	largeur
Abertura	profundidad	ancho
Apertura	profondità	larghezza
A	B	C



MORSE-FAVOLORO

	A = mm	B = mm	C = mm
56.273.16	160 mm	17 mm	22 mm

für Kinder · for children · pour enfants · para niños · per bambini

MORSE-FAVOLORO

	A = mm	B = mm	C = mm
56.273.19	200 mm	22 mm	27 mm

für Erwachsene · for adults · pour adultes · para adultos · per adulti



HERTZLER

	A = mm	B = mm	C = mm
56.278.00	105 mm	25 mm	25 mm

Rippensperrer und -Kontraktor
mit drehbaren Klauen

Rib spreader and contractor
with swivel blades

Ecarteur et rapprocheur des côtes
avec valves orientables

Separador y contractor costal
con garras girables

Divaricatore ed approssimatore costale
con valve orientabili

für Kinder
for children
pour enfants;
para niños
per bambini

für Erwachsene
for adults
pour adultes
para adultos
per adulti



SELLORS
56.280.19
19,0 cm



BAILEY-BABY
56.282.14
15,5 cm



BAILEY
56.284.16
20,0 cm



BAILEY-GIBBON
56.286.16
20,0 cm

Lunge
Lung
Poumon
Pulmón
Polmone

dimeda[®]

SURGICAL INSTRUMENTS

Lungenspatel
Lung Spatulas
Spatule pulmonaire
Espátula para el pulmón
Spatole per polmone



cm	ALLISON
25,5	56.289.30
32,0	56.289.32

Lungenfaßzangen
Lung Grasping Forceps
Pinces à saisir le poumon
Pinzas para coger el pulmón
Pinze per afferrare il polmone



LOVELACE
56.290.20
20,0 cm



LOVELACE
56.291.20
20,0 cm

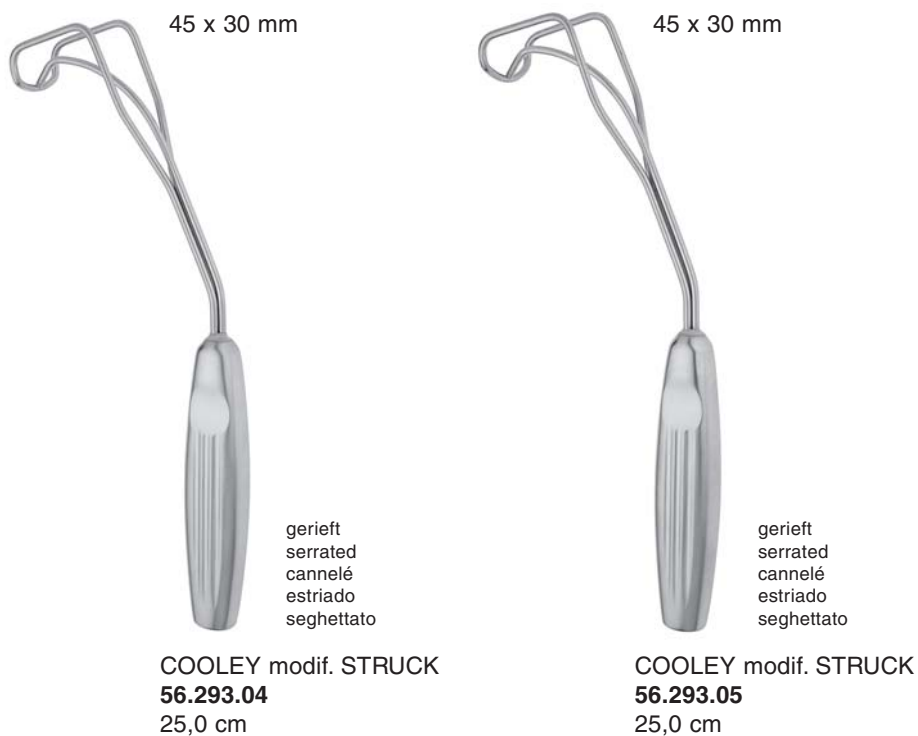
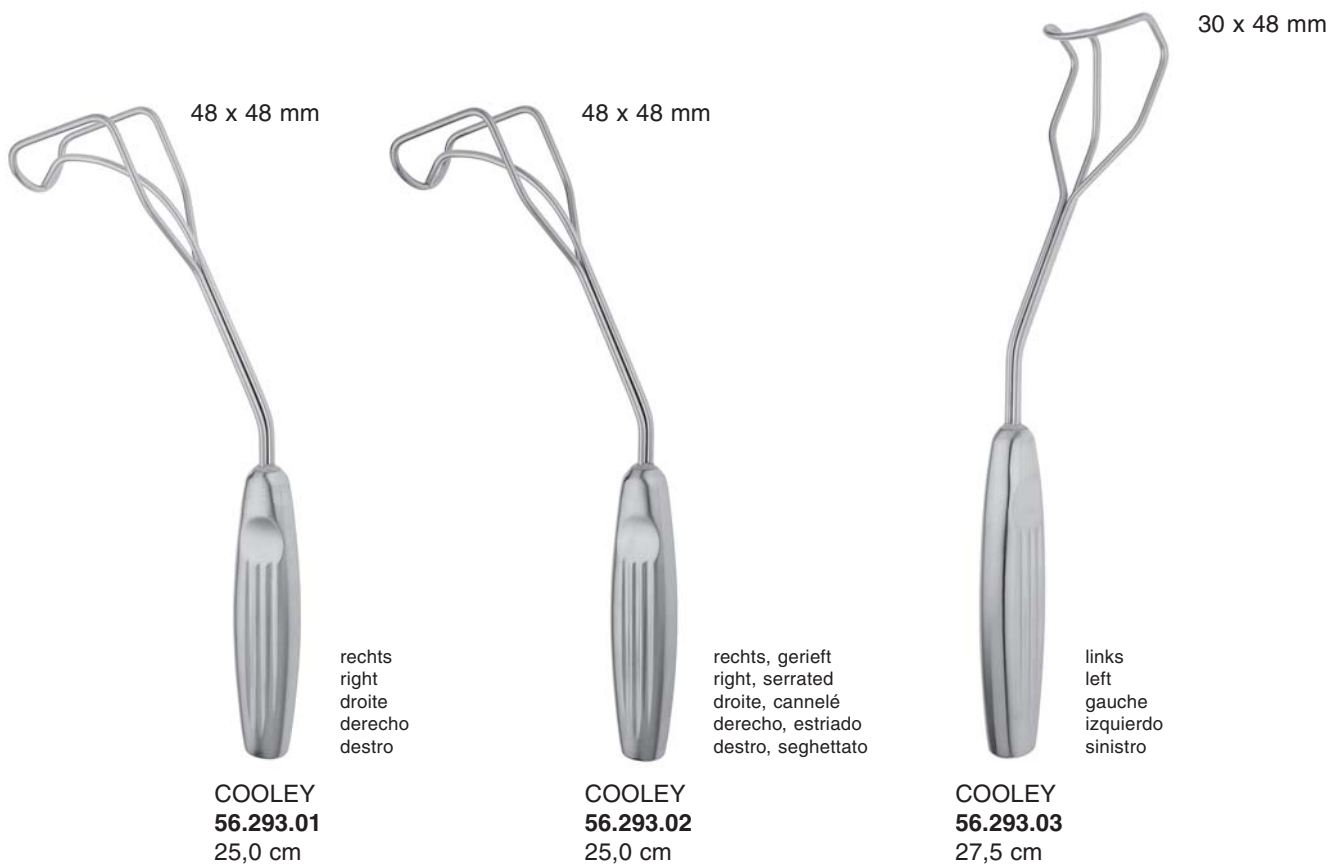

Bronchusklemmen
Bronchus Forceps
Pincers-Clamps à Bronches
Pinzas clamps bronquiales
Pinze per bronchi



HARRINGTON
56.301.30
30,5 cm



cm HARRINGTON
29,0 **56.303.29**
31,0 **56.303.31**



FINOCHIETTO
56.307.24
24,0 cm

Bronchusklemmen
Bronchus Forceps
Pinces-Clamps à Bronches
Pinzas clamps bronquiales
Pinze per bronchi



PRICE-THOMAS
56.309.22
22,0 cm



links
left
à gauche
izquierda
sinistra

PRICE-THOMAS
56.311.22
22,0 cm



rechts
right
à droite
derecha
destra

PRICE-THOMAS
56.313.22
22,0 cm

Bronchusklemmen
Bronchus Forceps
Pincas-Clamps à Bronches
Pinzas clamps bronquiales
Pinze per bronchi



SAROT
56.317.23
23,0 cm



SAROT
56.319.23
23,0 cm



SAROT



SEMB
56.321.23
23,0 cm

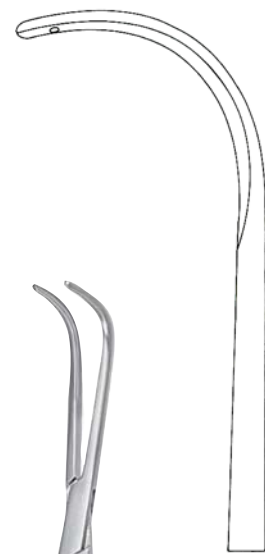

SEMB
56.323.23
23,0 cm

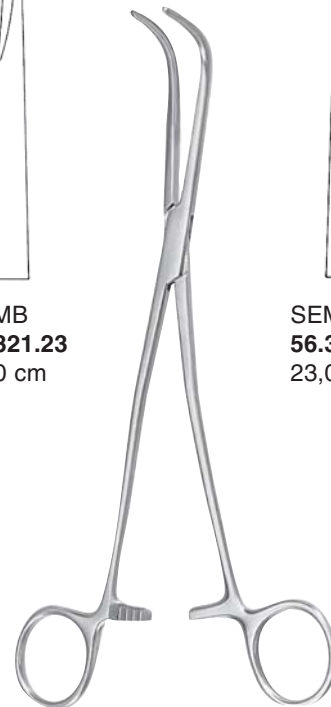

SEMB

Anastomosen- (Vena cava) Klemmen
Anastomosis (Vena Cava) Clamps
Pinces-clamps à anastomose (veine cave)
Pinzas clamps para anastomosis (vena cava)
Pinze per anastomosi (vena cava)



SATINSKY
56.325.15
15,0 cm



SATINSKY

56.327.26
Fig. 1
26,5 cm

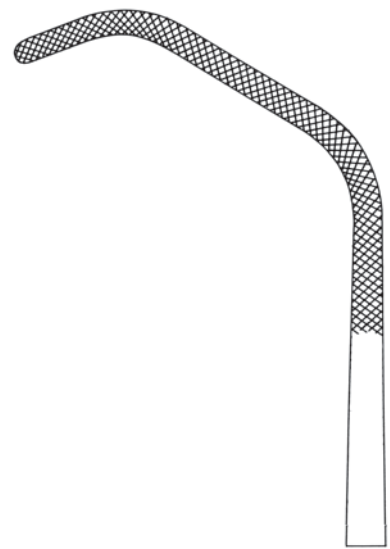

56.329.26
Fig. 2
26,5 cm

Anastomosen- (Vena cava) Klemmen
Anastomosis (Vena Cava) Clamps
Pinces-clamps à anastomose (veine cave)
Pinzas clamps para anastomosis (vena cava)
Pinze per anastomosi (vena cava)



SATINSKY

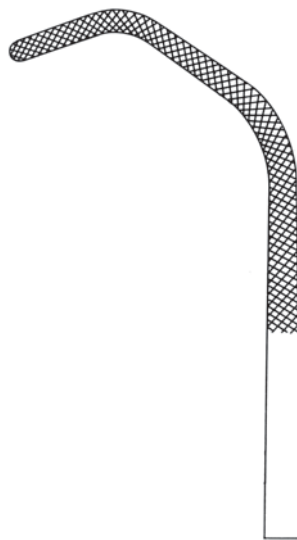

56.331.26
Fig. 1
26,5 cm

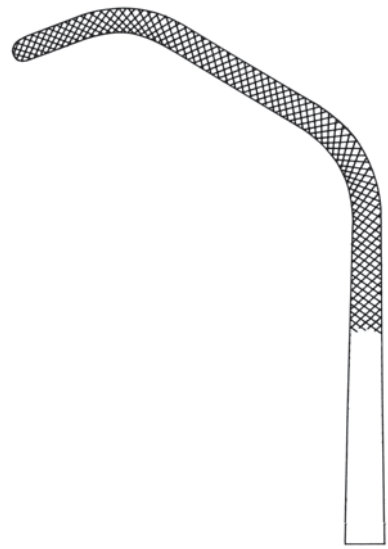

56.333.26
Fig. 2
26,5 cm



BROCK
56.410.00

Griff allein
 Handle only
 Manche seul
 Mango suelto
 Manico solo



BROCK
56.412.00

Dilatator Spreizweite 8 - 20 mm
 Dilator Opening 8 to 20 mm
 Dilatateur ouverture 8 à 20 mm
 Dilatador abertura 8 a 20 mm
 Dilatore apertura 8 a 20 mm

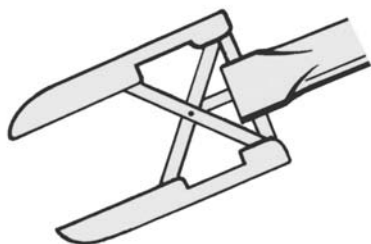

ø mm	BROCK
4,0	56.414.04
7,5	56.414.07
10,0	56.414.10
12,0	56.414.12

Stanzen
 Punches
 Pincas coupantes
 Pinzas cortantes
 Pinze taglianti

Herz-Dilatatoren
Mitral Valve Dilators
Dilatateurs pour valve mitrale
Dilatadores para válvula mitral
Dilatatori per valvole mitrali

dimed[®]

SURGICAL INSTRUMENTS

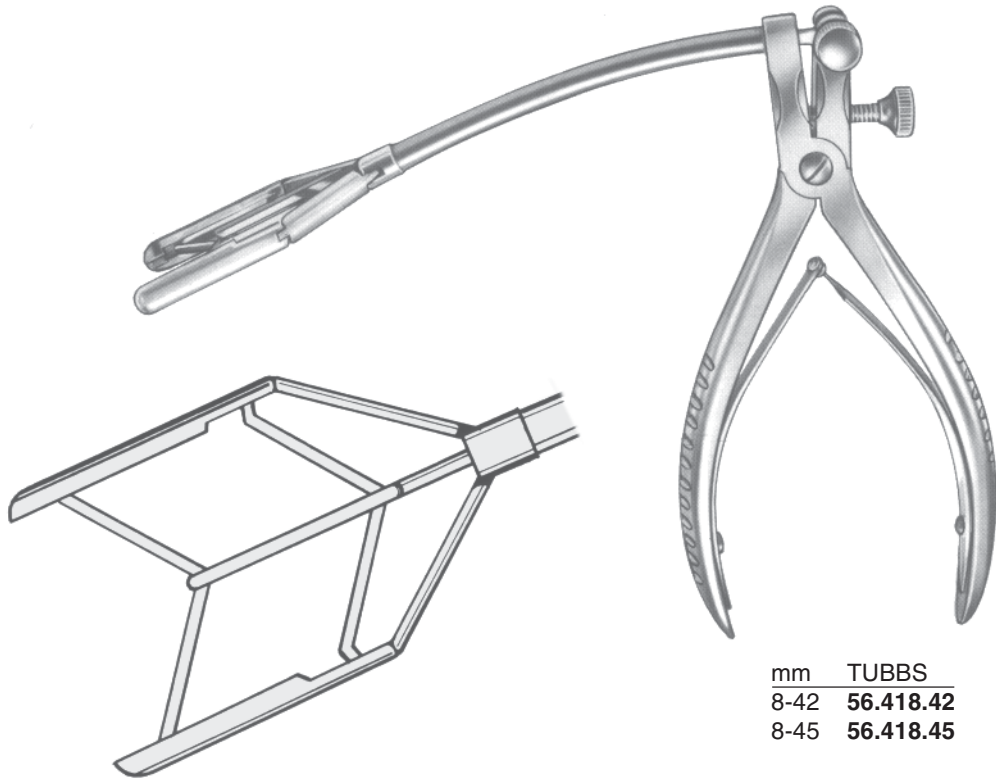

mm	TUBBS
8-42	56.418.42
8-45	56.418.45

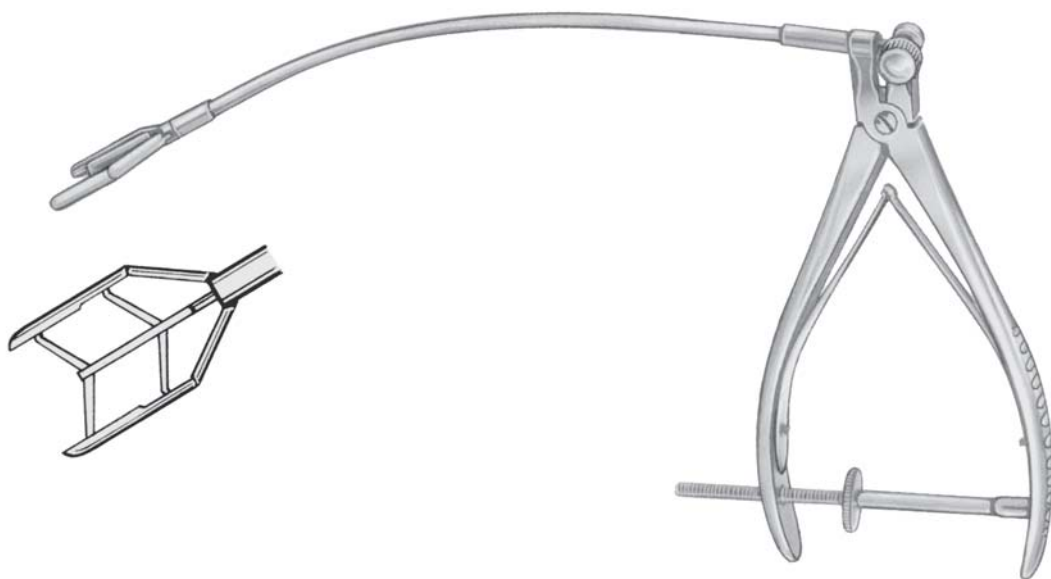

mm	COOLEY
8-15	56.420.15
8-45	56.420.45

Herz-Dilatatoren
Mitral Valve Dilators
Dilatateurs pour valve mitrale
Dilatadores para válvula mitral
Dilatatori per valvole mitrali

dimeda[®]

SURGICAL INSTRUMENTS

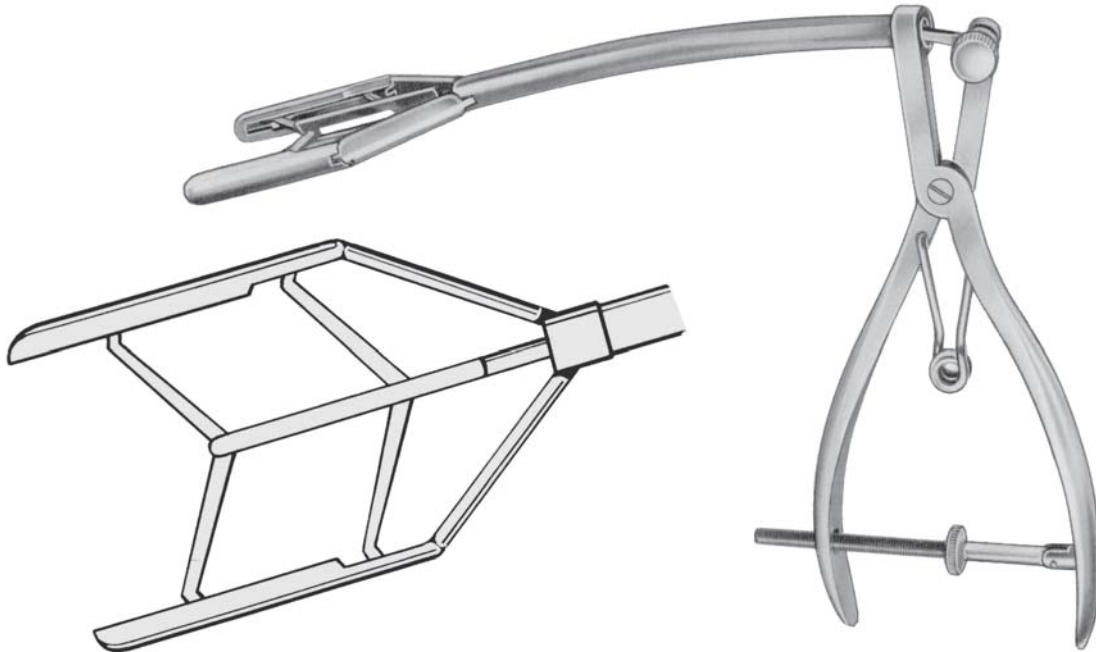

mm GERBODE
9-45 56.422.45

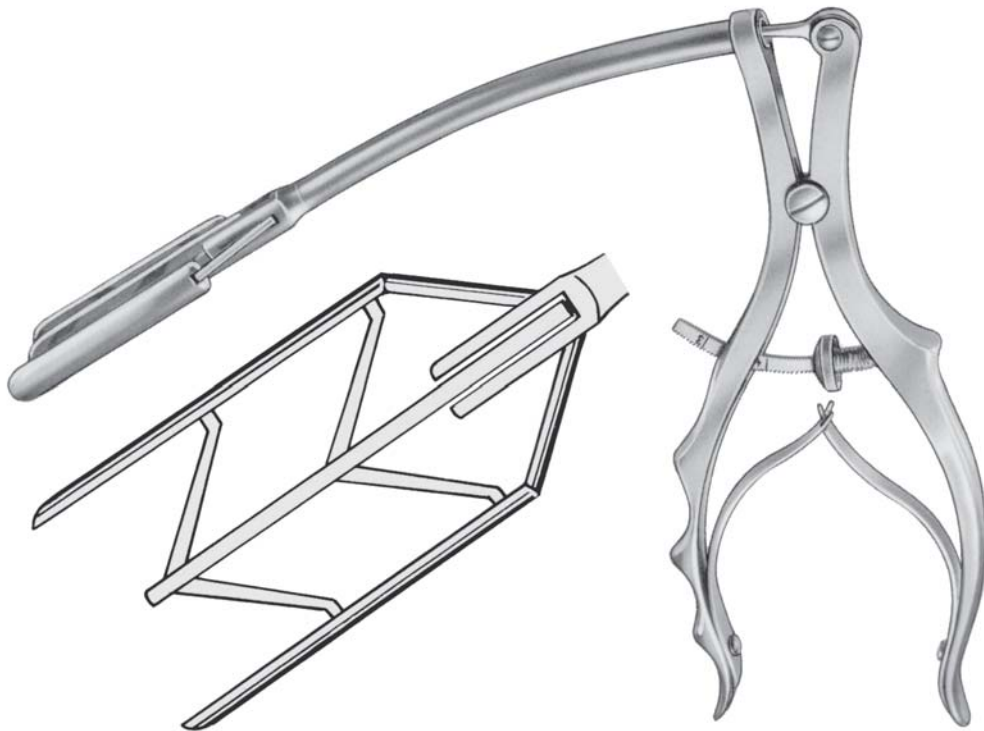

mm COOLEY
7-30 56.423.30
9-40 56.423.40

Herz-Dilatatore
Mitral Valve Dilators
Dilatateurs pour valve mitrale
Dilatadores para válvula mitral
Dilatatori per valvole mitrali

dimeda[®]

SURGICAL INSTRUMENTS



mm	COOLEY
5-18	56.425.18
6-20	56.425.20



mm	HETZER
4-10	56.426.10

biegsam, Silber
malleable, silver
malléables, argent
maleables, silver
maleabili, argento

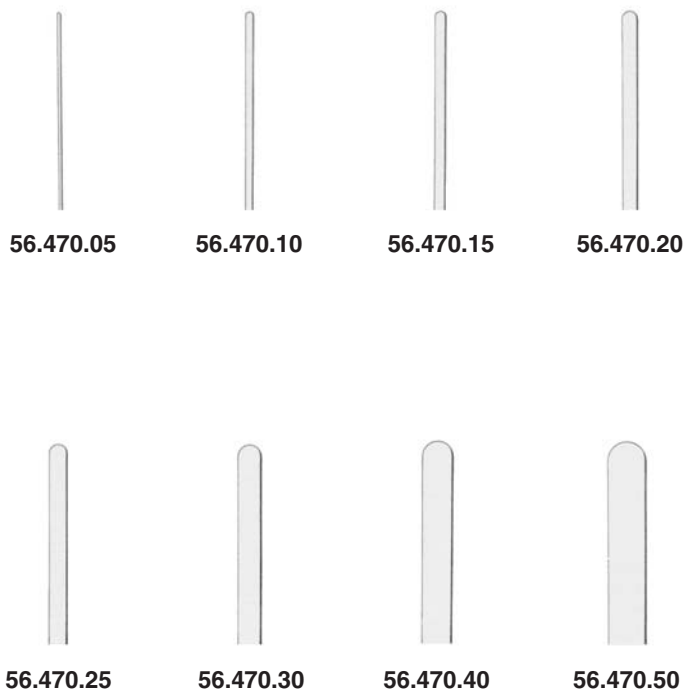

56.470.05

56.470.10

56.470.15

56.470.20

56.470.25

56.470.30

56.470.40

56.470.50

COOLEY	
ø mm	13,0 cm
0,5	56.470.05
1,0	56.470.10
1,5	56.470.15
2,0	56.470.20
2,5	56.470.25
3,0	56.470.30
4,0	56.470.40
5,0	56.470.50

biegsam
 malleable
 malléables
 maleables
 maleabili

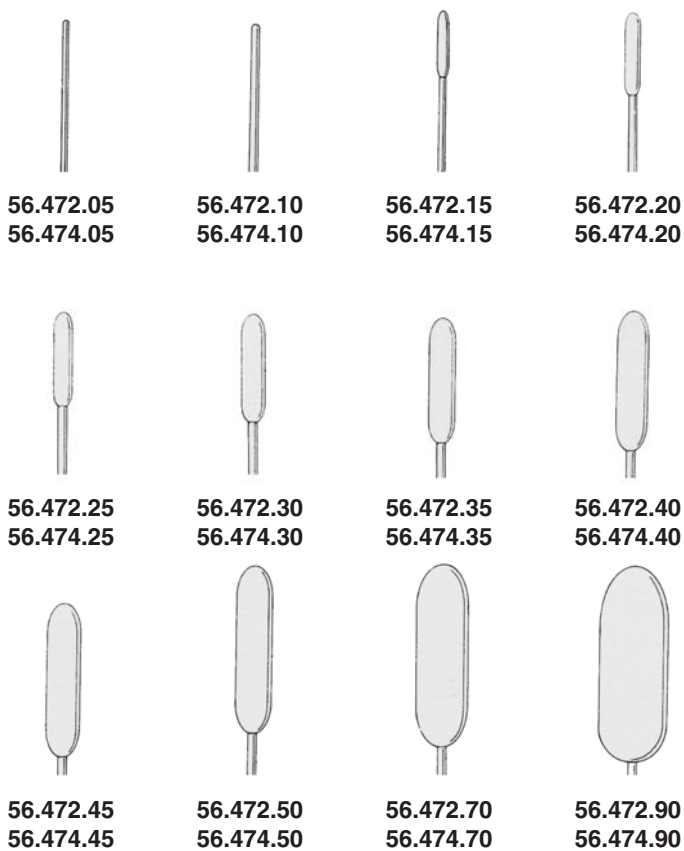

56.472.05
56.474.05

56.472.10
56.474.10

56.472.15
56.474.15

56.472.20
56.474.20

56.472.25
56.474.25

56.472.30
56.474.30

56.472.35
56.474.35

56.472.40
56.474.40

56.472.45
56.474.45

56.472.50
56.474.50

56.472.70
56.474.70

56.472.90
56.474.90

DEBAKEY

ø mm	19,0 cm	35,0 cm
0,5	56.472.05	56.474.05
1,0	56.472.10	56.474.10
1,5	56.472.15	56.474.15
2,0	56.472.20	56.474.20
2,5	56.472.25	56.474.25
3,0	56.472.30	56.474.30
3,5	56.472.35	56.474.35
4,0	56.472.40	56.474.40
4,5	56.472.45	56.474.45
5,0	56.472.50	56.474.50
7,0	56.472.70	56.474.70
9,0	56.472.90	56.474.90

Intima-Spatel
Intima spatula
Spatule pour la tunique interne
Espátula para la íntima
Spatola per intima

dimeda[®]

SURGICAL INSTRUMENTS

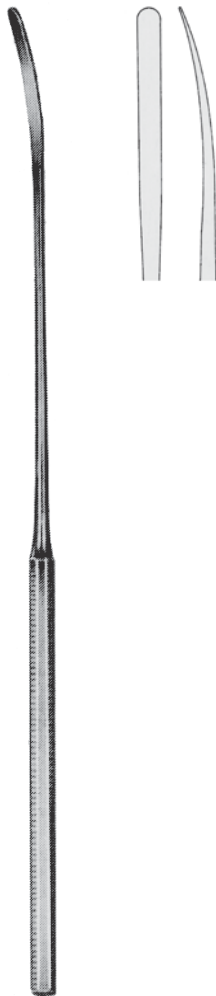

cm
18,0 **56.505.18**
21,0 **56.505.21**

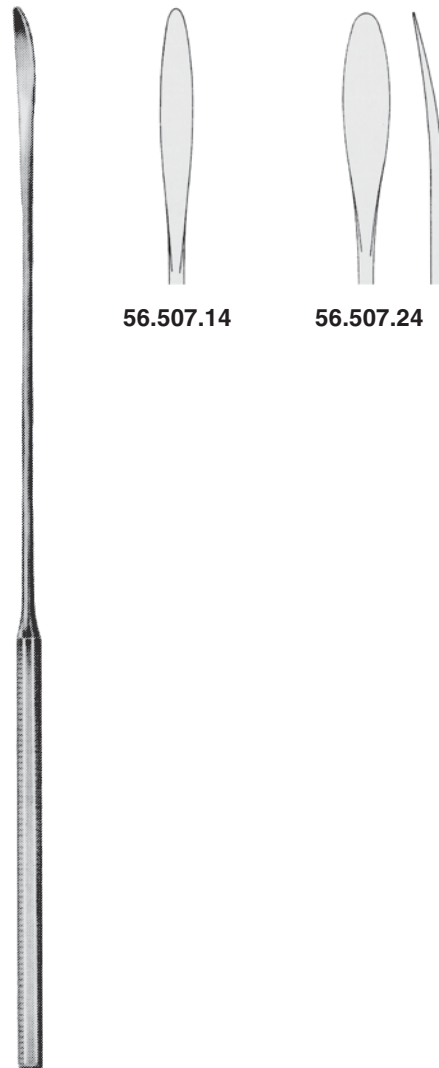

56.507.14

56.507.24

cm 3 mm
14,0 **56.507.14**
24,0 **56.507.24**

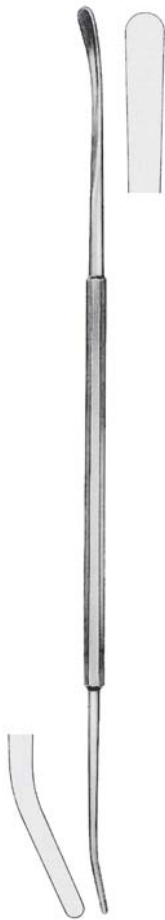

ROBB
56.509.01
Fig. 1
24,0 cm



ROBB
56.509.02
Fig. 2
24,0 cm



ROBB
56.509.03
Fig. 3
24,0 cm

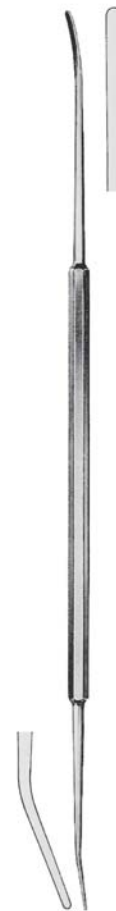

ROBB
56.509.04
Fig. 4
24,0 cm

dimeda[®]

SURGICAL INSTRUMENTS