

Orthopädie, Osteosynthese  
Bone Surgery, Osteosynthesis  
Chirurgie osseuse, Ostéosynthèse  
Cirugía ósea, Osteosíntesis  
Chirurgia ossea, Osteosintesi

Komprimeter  
Comprimeter  
Comprimètre  
Torniquete  
Apparecchio per vuoto di sangue

*dimeda*<sup>®</sup>

SURGICAL INSTRUMENTS

Komprimeter zur Erzeugung von Blutleere in den Gliedern  
Compression Apparatus for producing blood vacuum in limbs  
Appareil compressif permettant d'obtenir un milieu exsangue des membres  
Aparato de compresión para producir el vacío de sangre en los miembros  
Vacumetro per determinare vuoti di sangue nelle membra



33.101.01  
compl.

Amputation, Finger  
 Amputation, Fingers  
 Amputation, doigts  
 Amputación, dedos  
 Amputazione, dita

**dimeda**<sup>®</sup>

SURGICAL INSTRUMENTS

mm	
12	33.112.12
15	33.112.15
18	33.112.18

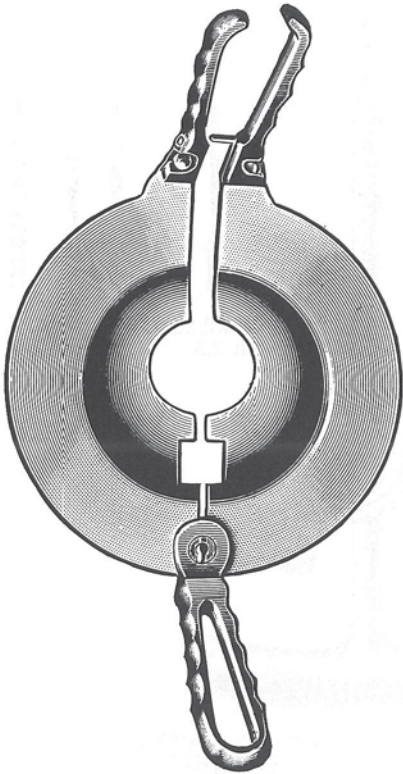

PERCY  
33.110.00

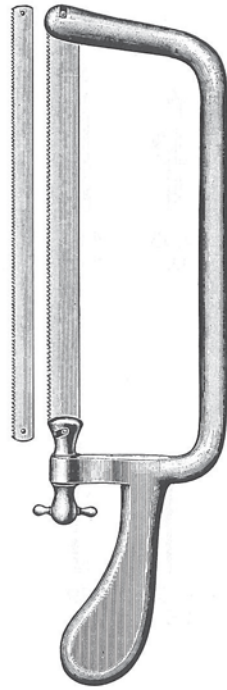

CHARRIERE  
33.112.00

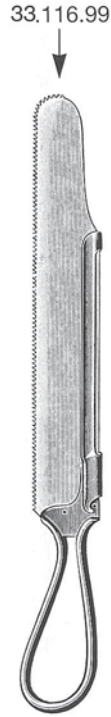

CHARRIERE  
33.116.30  
30 cm

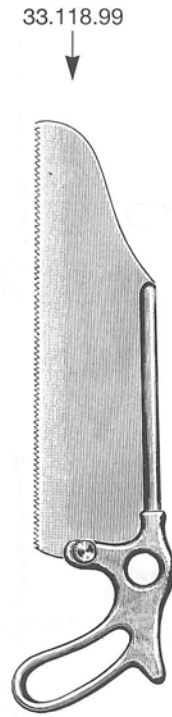

SATTERLEE  
33.118.31  
31 cm



LANGENBECK  
33.120.23  
23 cm

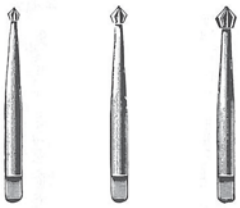

33.160.01

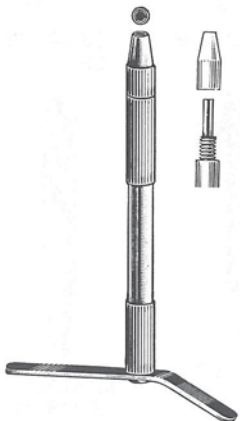

33.160.00  
Compl. incl.  
33.160.01

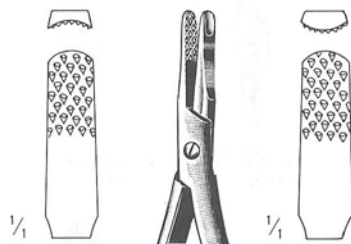

RADOLF  
33.162.13  
13,5 cm

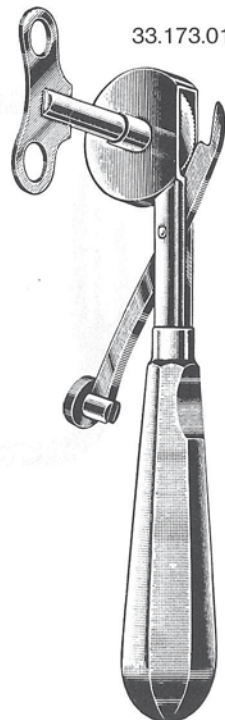

DIMEDA  
33.173.00  
17 cm



33.175.00

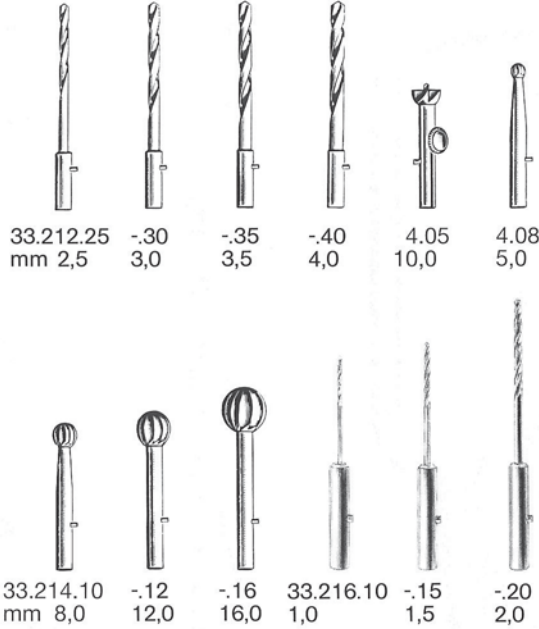
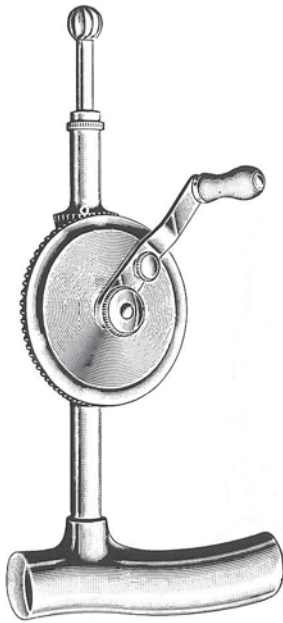

**STILLE**  
 33.210.20  
 Compl. 20 cm

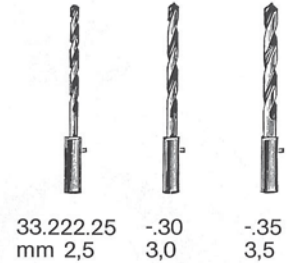
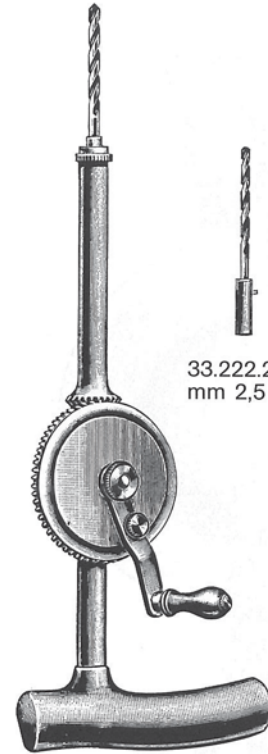

**STILLE-SHERMAN**  
 33.220.24  
 Compl. 24 cm

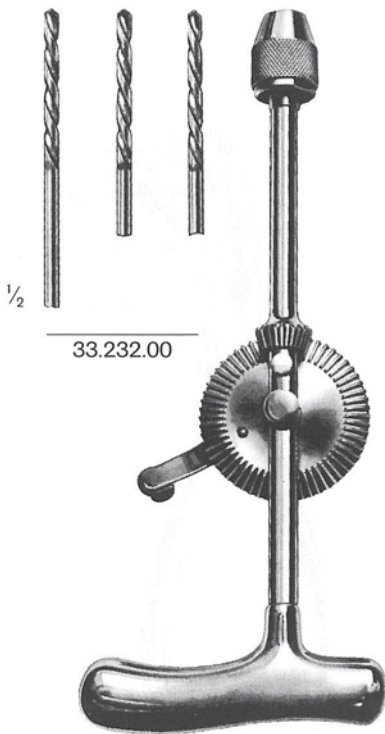

**MOORE**  
 33.230.28  
 Compl. 28 cm

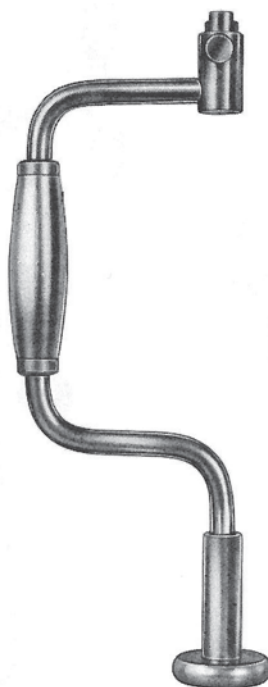

**HUDSON**  
 33.240.27  
 Compl. incl. 33.242.09, -14, -16, -22, 33.246.00  
 27 cm

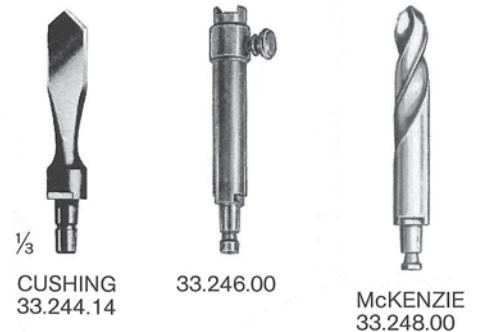

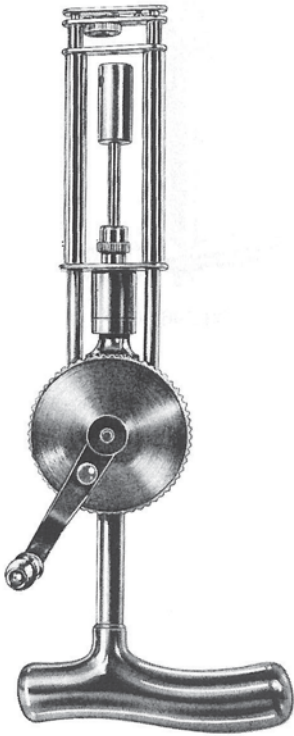

KIRSCHNER  
 33.250.00  
 Compl.



33.252.00

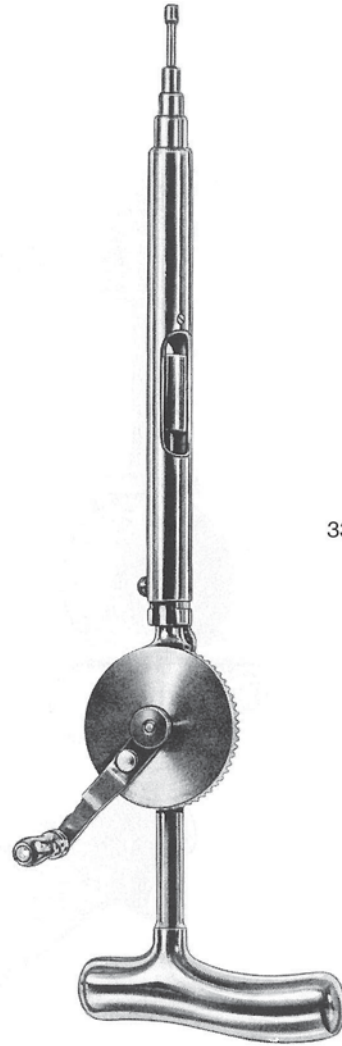

33.260.00  
 Compl.



33.262.00

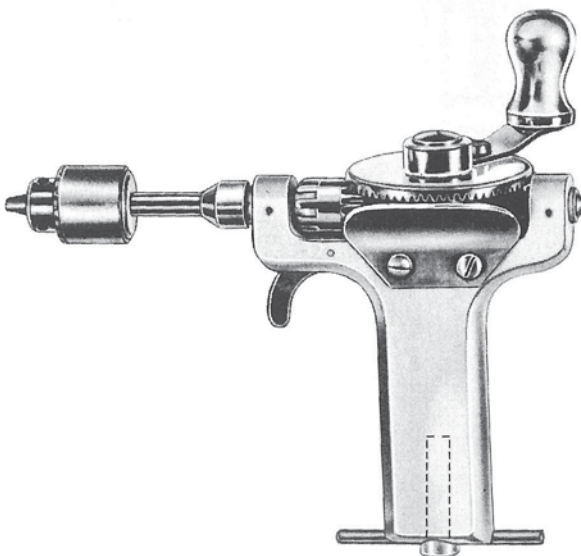

BUNNELL  
 33.270.00  
 16 cm

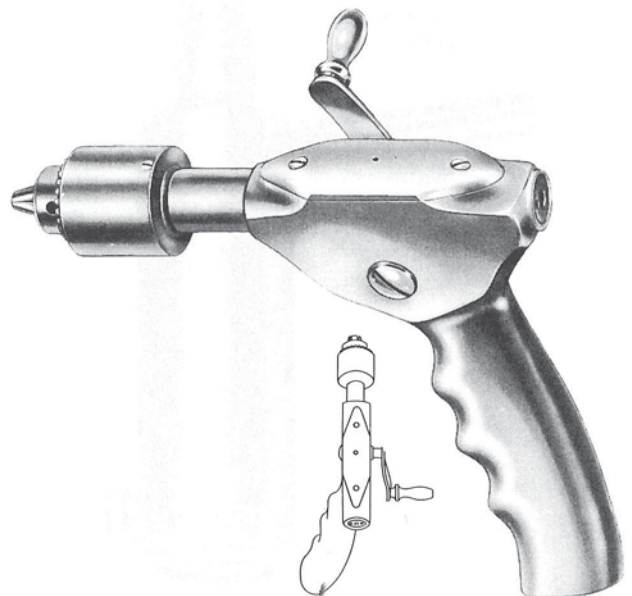

RALK  
 33.280.00

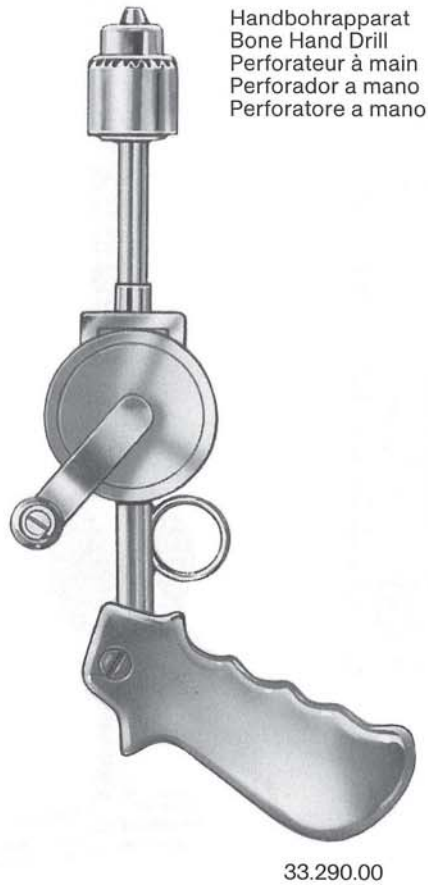

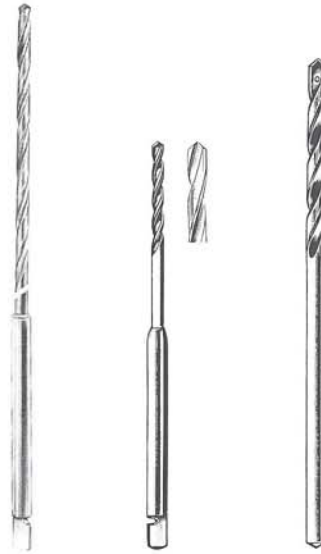

mm			
1,0		33.352.10	33.354.10
1,2		33.352.12	
1,5		33.352.15	33.354.15
1,8		33.352.18	
2,0	33.350.20	33.352.20	33.354.20
2,2		33.352.22	
2,5	33.350.25	33.352.25	33.354.25
2,8		33.352.28	33.354.28
3,0	33.350.30	33.352.30	33.354.30
3,2	33.350.32	33.352.32	33.354.32
3,5	33.350.35	33.352.35	33.354.35
4,0	33.350.40	33.352.40	33.354.40
5,0	33.350.50	33.352.50	33.354.50
6,0	33.350.60		33.354.60
7,0	33.350.70		



mm Ø	DOYEN	DOYEN	DOYEN	DOYEN	ALBEE	ALBEE	BORCHARDT	TOTI
4	33.362.04	33.364.04						
6	33.362.06	33.364.06						
7						33.374.07		
8	33.362.08	33.364.08		33.368.08		33.372.08		33.378.08
10	33.362.10	33.364.10		33.368.10		33.372.10		
12	33.362.12	33.364.12	33.366.12		33.370.12	33.372.12		
13							33.376.13	
14	33.362.14	33.364.14						
15					33.370.15			
16	33.362.16	33.364.16						
25								33.377.25

Reibahlen  
Reamer  
Pointes-carrées  
Escariadores  
Punteruoli



33.392.14  
14 cm



¼

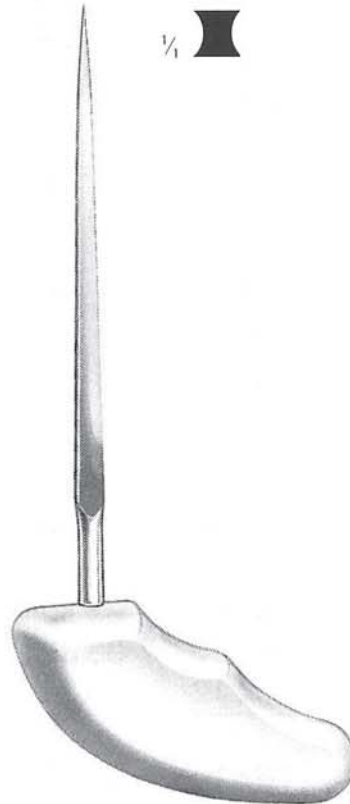

¼

PERTHES  
33.395.21  
21 cm



lieferbar in Packungen à 10 Stück  
available in packages with 10 pieces  
disponibles en paquets de 10 pièces  
disponible en paquets de 10 unidades  
disponibili in confezioni da pezzi



Trokarspitze  
Trocar tip  
Pointe trocart  
Punta en forma de trócar  
Punte a trequarti

mm Ø	L = 60 mm	L = 120 mm	L = 140 mm	L = 160 mm	L = 310 mm
1,0	33.406.10	33.412.10	33.414.10	33.416.10	33.431.10
1,2	33.406.12	33.412.12	33.414.12	33.416.12	33.431.12
1,4	33.406.14	33.412.14	33.414.14	33.416.14	33.431.14
1,5	33.406.15	33.412.15	33.414.15	33.416.15	33.431.15
1,6	33.406.16	33.412.16	33.414.16	33.416.16	33.431.16
1,8	33.406.18	33.412.18	33.414.18	33.416.18	33.431.18
2,0	33.406.20	33.412.20	33.414.20	33.416.20	33.431.20
2,2	33.406.22	33.412.22	33.414.22	33.416.22	33.431.22
2,5				33.416.25	33.431.25

KIRSCHNER  
33.406.10 - 33.431.25

lieferbar in Packungen à 10 Stück  
available in packages with 10 pieces  
disponibles en paquets de 10 pièces  
disponible en paquets de 10 unidades  
disponibili in confezioni da pezzi



Lanzenspitze  
Lancet tip  
Pointe lancéolaire  
Punta lanceolar  
Punte lanceolari

mm Ø	L = 310mm
1,0	33.432.10
1,2	33.432.12
1,5	33.432.15
1,6	33.432.16
1,8	33.432.18
2,0	33.432.20
2,2	33.432.22
2,5	33.432.25

KIRSCHNER  
33.432.10 - 33.432.25

STEINMANN Nägel  
STEINMANN Pins  
STEINMANN clous à os  
STEINMANN clavos p. huesos  
STEINMANN chiodi per ossa



L cm	
13	33.490.13
14	33.490.14
15	33.490.15
16	33.490.16
18	33.490.18
20	33.490.20
21	33.490.21

STEINMANN  
33.490.13 - 33.490.21

Exentionsbügel  
 Extension Bow  
 Etriers à exention  
 Estribos para extensión  
 Archi per estensione

**dimeda**<sup>®</sup>

SURGICAL INSTRUMENTS

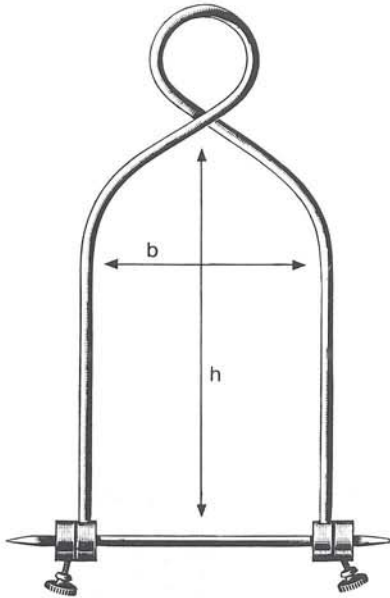

hxb cm	BOEHLER
16x 9	33.502.16
16x11	33.502.21

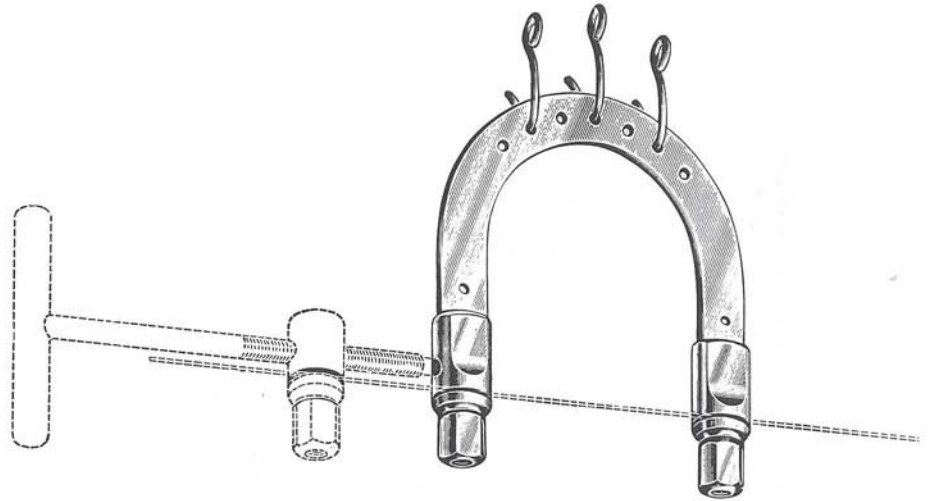

hxb cm	KIRSCHNER
6,0x 5,0	33.512.06
9,5x 7,0	33.512.09
10,5x 10,5	33.512.10
9,5x 11,0	33.512.11
12,0x 12,0	33.512.12
13,5x 13,0	33.512.13
15,5x 15,5	33.512.15
20,0x 15,5	33.512.20



hxb cm	
18x 10	33.514.18
27x 16	33.514.27



33.515.01



33.515.02

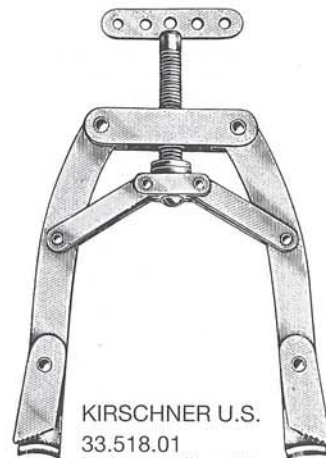

KIRSCHNER U.S.  
 33.518.01  
 klein · small · petit  
 pequeño · piccolo  
 33.518.02  
 groß · large size  
 grand · grande  
 33.518.03  
 extra groß · extra large size  
 extra grand · extra grande

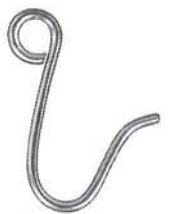

33.519.01

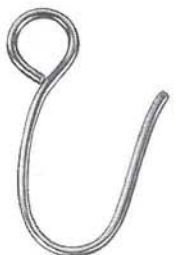

33.519.02

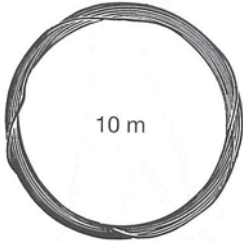

weich  
 soft  
 souple  
 blando  
 morbido

mm Ø

0,2	33.530.02
0,3	33.530.03
0,4	33.530.04
0,5	33.530.05
0,6	33.530.06
0,7	33.530.07
0,8	33.530.08
0,9	33.530.09
1,0	33.530.10
1,1	33.530.11
1,2	33.530.12
1,5	33.530.15

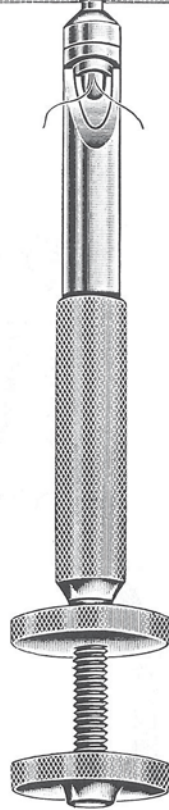
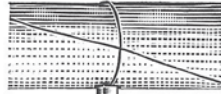

LOUTE  
 33.531.21  
 21 cm



1/4



33.532.17  
 17 cm

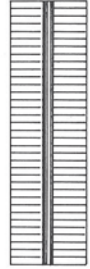

1/4

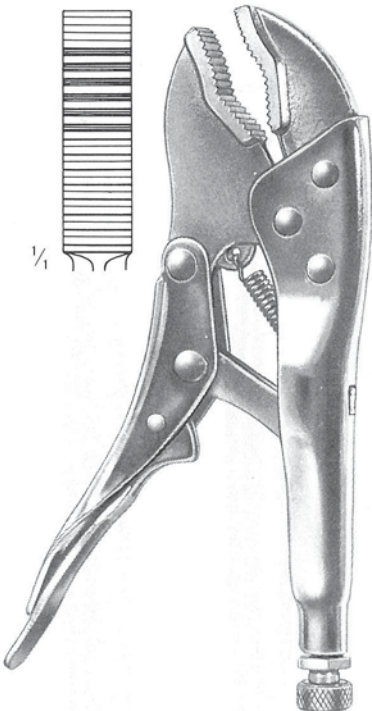

Grip  
 33.533.18  
 18 cm



33.534.15  
 15 cm

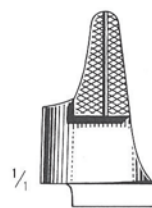

1/4

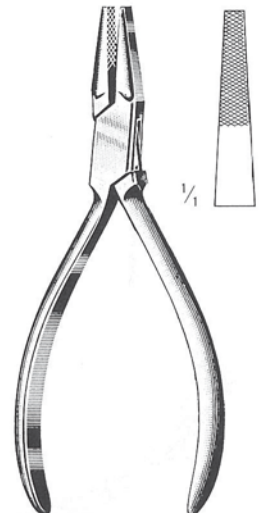

33.536.14  
 14 cm

Mit TC-Einsätzen  
 TC Lined  
 A mors TC  
 Con bocas TC  
 Con morso TC



33.540.16  
 16 cm



33.542.15  
 15 cm



33.545.22  
 22 cm

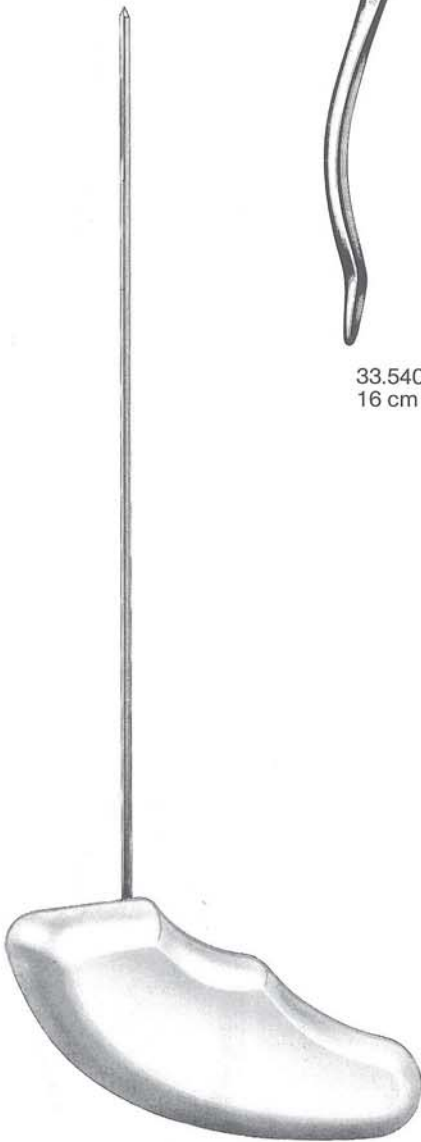

mm Ø	
2,4	33.560.24
3,2	33.560.32
4,8	33.560.48
6,4	33.560.64



33.562.24



33.562.32



33.562.48



33.562.64

f./p. Ø	2,4 mm	3,2 mm	4,8 mm	6,4 mm
---------	--------	--------	--------	--------

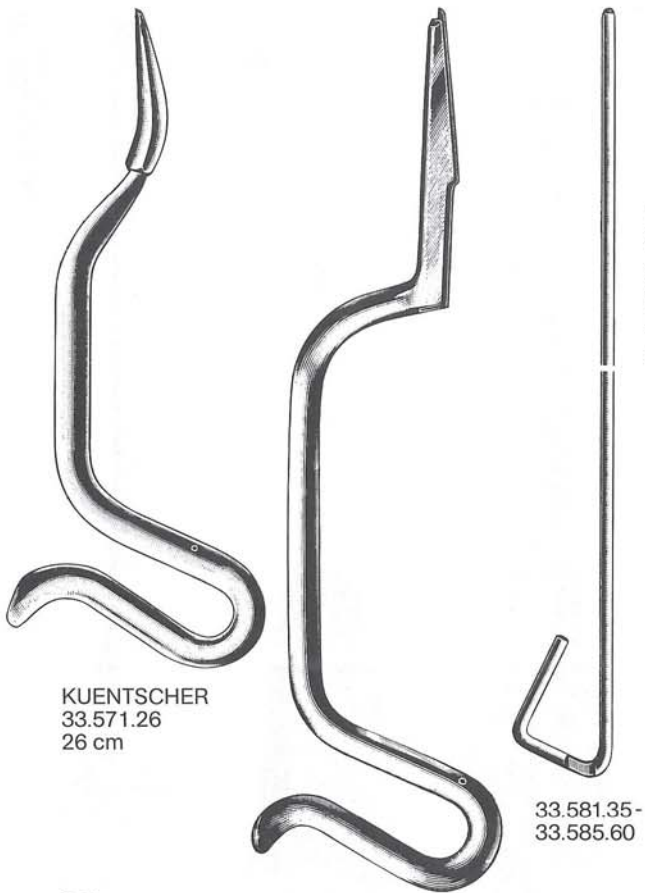

mm Ø	L = 35 cm	L = 46 cm	L = 60 cm
2,5	33.581.35	33.581.46	
3,0	33.582.35	33.582.46	
3,5	33.583.35	33.583.46	33.583.60
4,0	33.584.35	33.584.46	33.584.60
5,0	33.585.35	33.585.46	33.585.60

KUENTSCHER  
 33.571.26  
 26 cm

33.581.35-  
 33.585.60

KUENTSCHER  
 33.573.35  
 35 cm



KUENTSCHER  
 33.586.21  
 21 cm

KUENTSCHER  
 33.588.21  
 21 cm



$\frac{1}{3}$   
 33.590.01

$\frac{1}{3}$   
 33.590.02



$\frac{1}{3}$   
 33.590.03

33.590.04



KUENTSCHER  
 33.590.00  
 63 cm

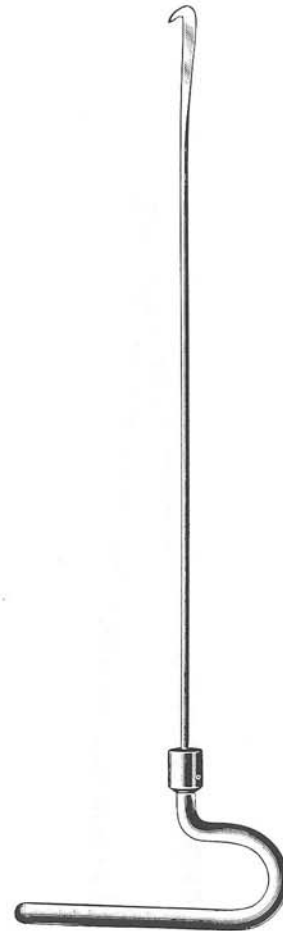

cm	
29	33.596.29
37	33.596.37
42	33.596.42
49	33.596.49



33.598.30

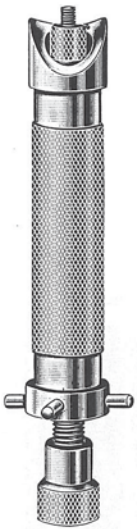

LLOYD  
 33.602.20  
 20 cm



LANE  
 33.620.25  
 25 cm



WILLIAMS  
 33.624.24  
 24 cm

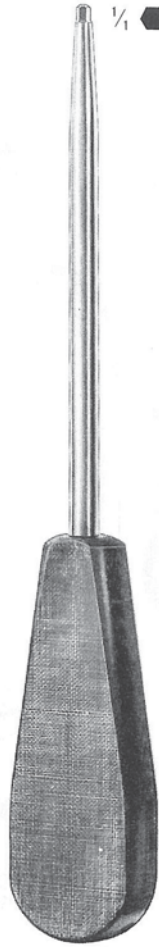

mm  
 2,5 33.628.25  
 3,5 33.628.35

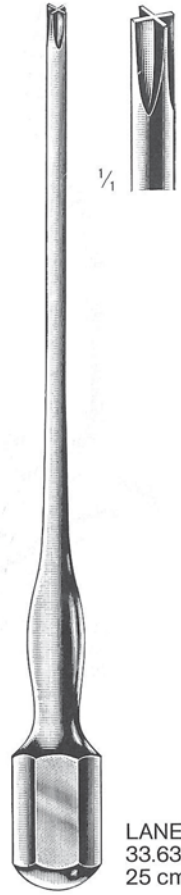

LANE  
 33.632.25  
 25 cm

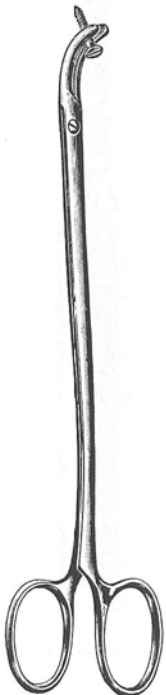

LANE  
 33.635.18  
 18 cm



LANE  
 33.637.23  
 23 cm

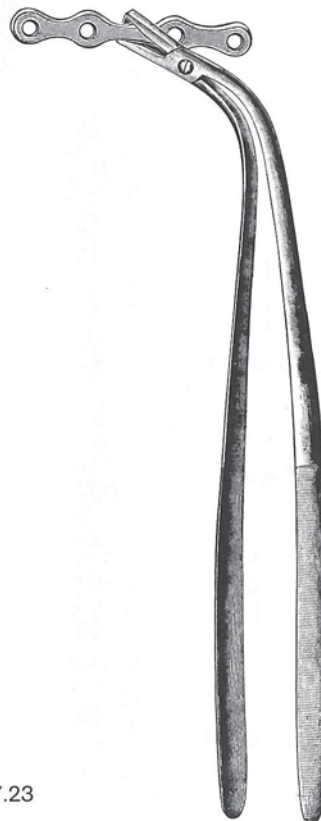

LANE  
 33.639.22  
 22 cm

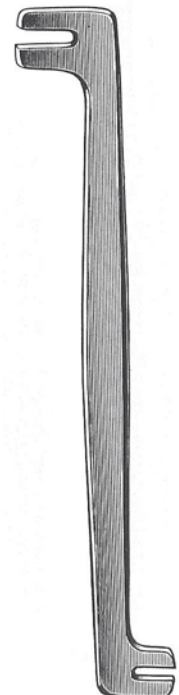

LANE  
 33.640.18  
 18 cm

Instrumentarium zum Einbringen von Hohlschrauben  
 Instrument Set for Cannulated Screws  
 Instrumentation pour l'application des vis à perforation longitudinale  
 Instrumental para la aplicación de tornillos de perforación longitudinal  
 Strumentario per viti cannulate



Ø mm	
4,5	33.802.45
7,0	33.802.70



33.810.05  
5 mm

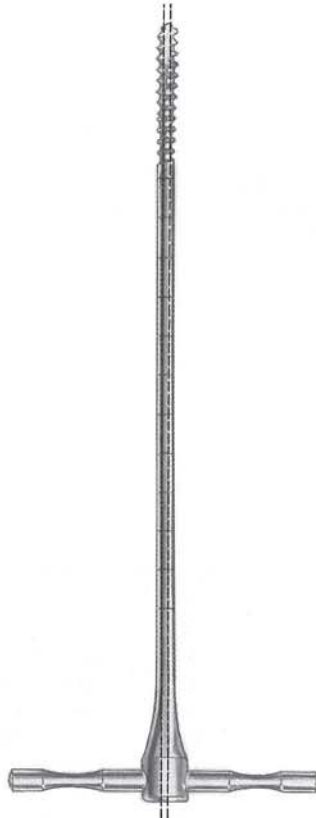

Ø mm	
4,5	33.812.45
7,0	33.812.70

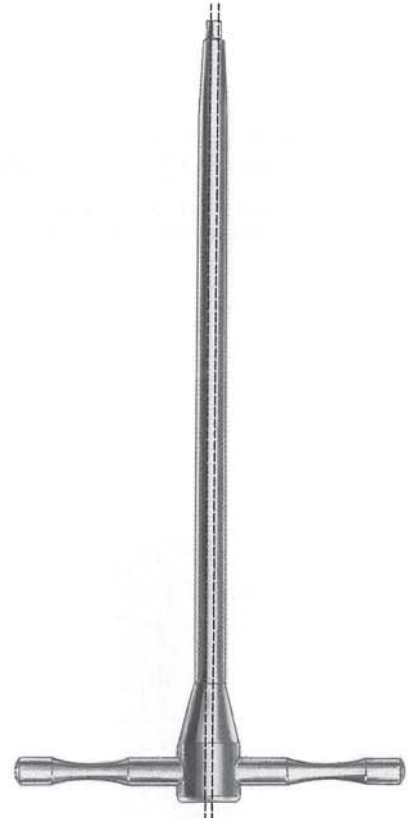

Ø mm	
2,5	33.816.25
3,5	33.816.35
5,0	33.816.50



33.820.00

*dimeda*<sup>®</sup>

SURGICAL INSTRUMENTS