

12

Arterienklemmen
Hemostatic Forceps
Pinces hémostatiques
Pinzas hemostáticas
Pinze emostatiche

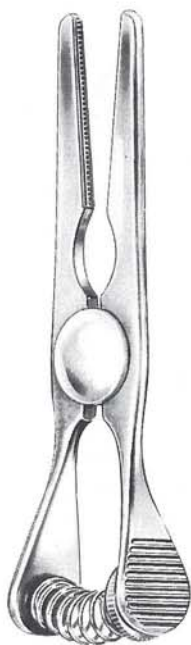

DE BAKEY
 12.092.07-12.093.12

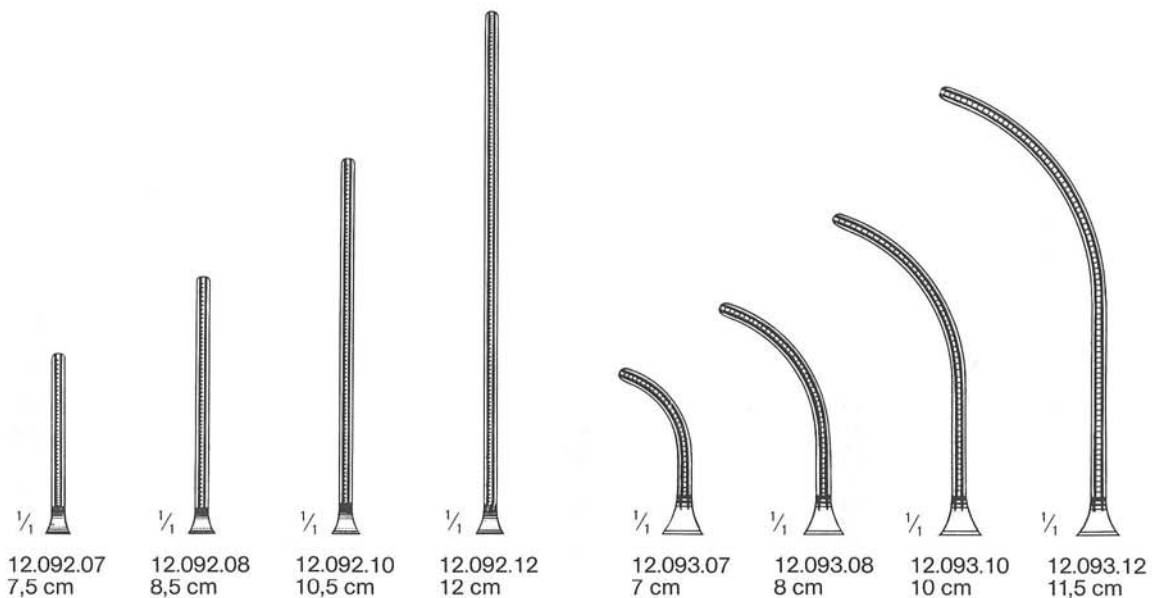

GLOVER
 12.096.06-12.097.11

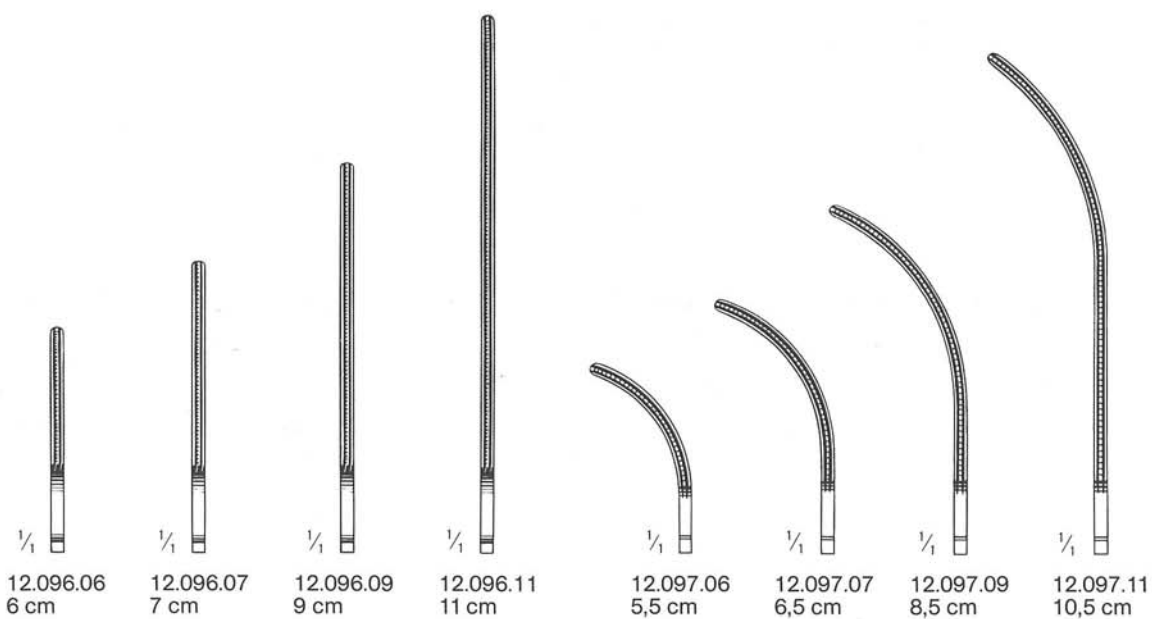

Arterienklemmen
 Hemostatic Forceps
 Pinces hémostatiques
 Pinzas hemostáticas
 Pinze emostatiche

dimeda[®]

SURGICAL INSTRUMENTS

Gefäßklemmen
 Serrefines
 Serre-fines
 Serra-finas
 Serrefine

cm	DIEFFENBACH		JOHNS-HOPKINS	
3,5	12.102.04	12.103.04	12.110.50	12.111.50
5,0	12.102.05	12.103.05	12.110.55	12.111.55
5,5			12.110.65	12.111.65
6,5			12.110.70	12.111.70
7,0			12.110.75	12.111.75
7,5			12.110.90	12.111.90
9,0				

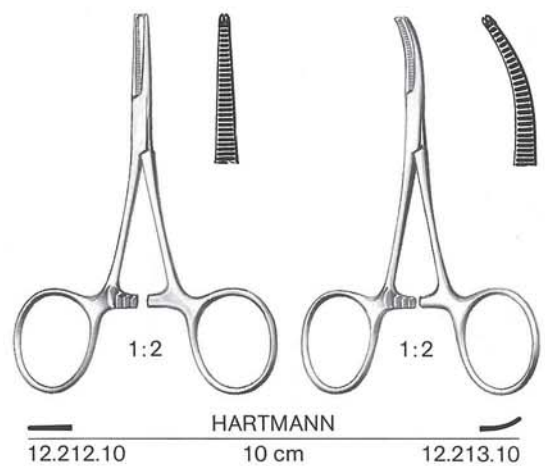
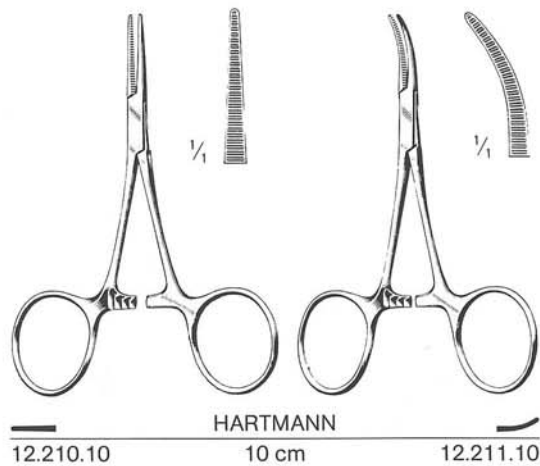

Titan
 Titanium
 Titane
 Titanio
 Titanio

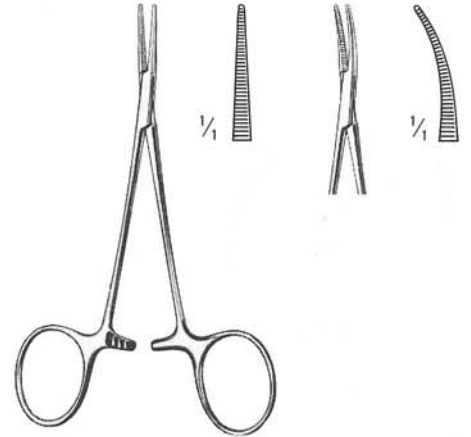
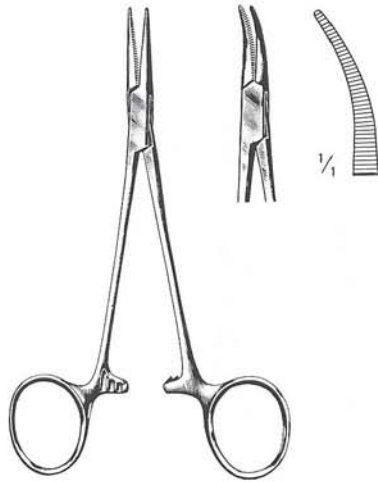

cm	— HALSTED-MOSQUITO —			— HALSTED-MOSQUITO micro —		
12,5	12.224.12	12.220.12	12.221.12	12.225.12	12.222.12	12.223.12
14,0		12.220.14	12.221.14			
18,0		12.220.18	12.221.18			
21,0		12.220.21	12.221.21			

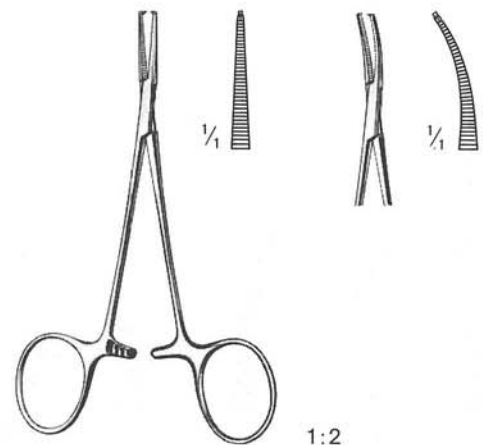
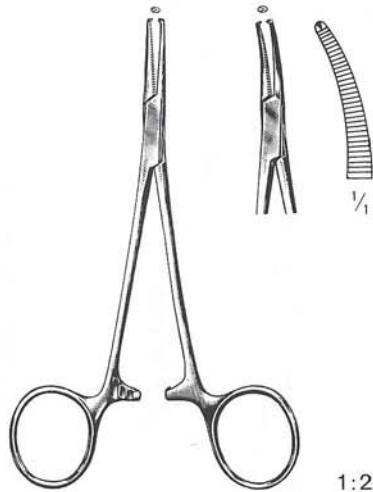

cm	— HALSTED-MOSQUITO —			— HALSTED-MOSQUITO micro —		
12,5	12.234.12	12.230.12	12.231.12	12.235.12	12.232.12	12.233.12
14,0		12.230.14	12.231.14			
18,0		12.230.18	12.231.18			
21,0		12.230.21	12.231.21			

Titan
 Titanium
 Titane
 Titanio
 Titanio

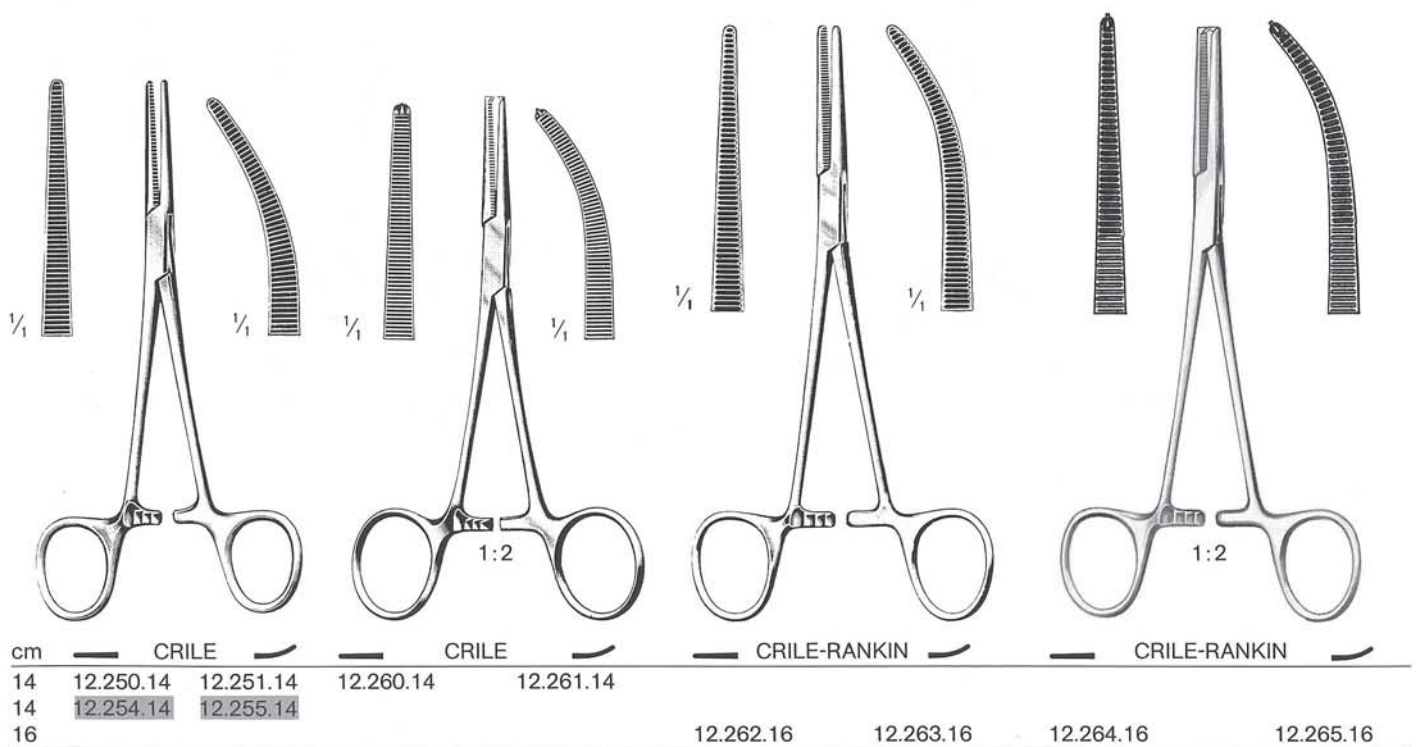
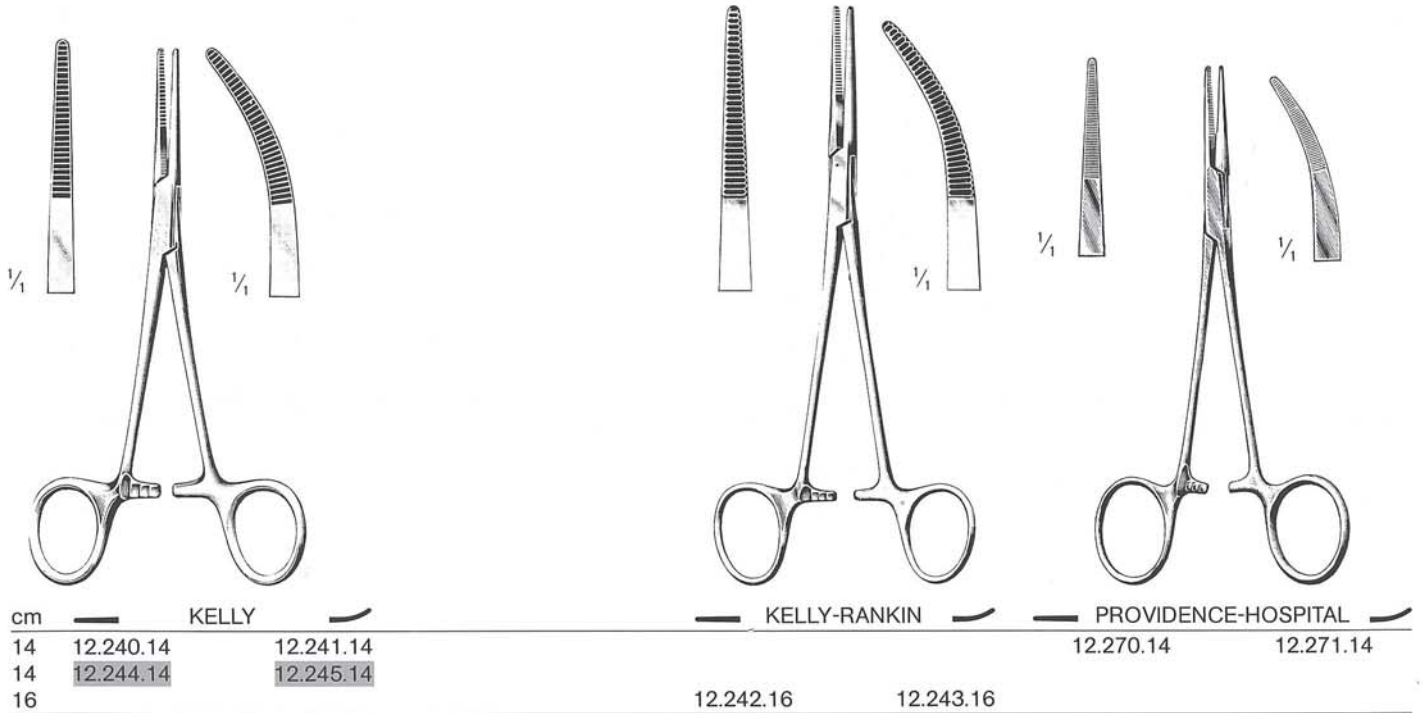

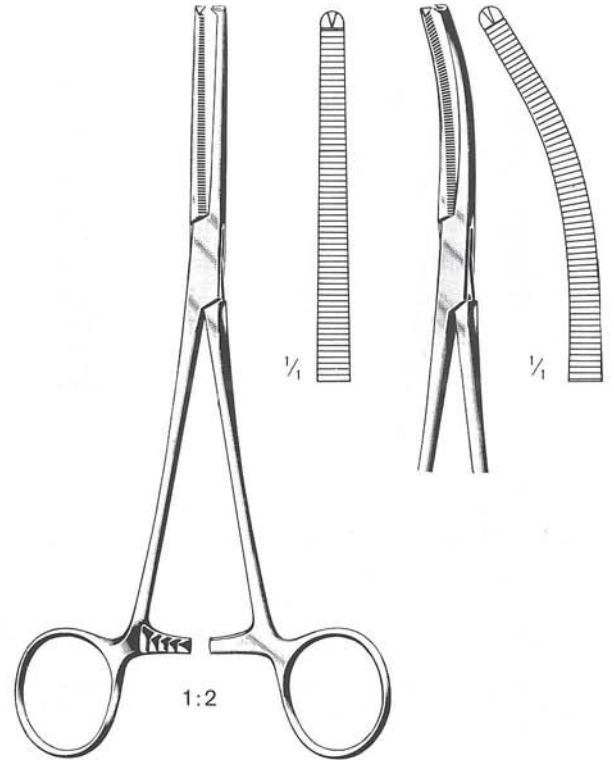
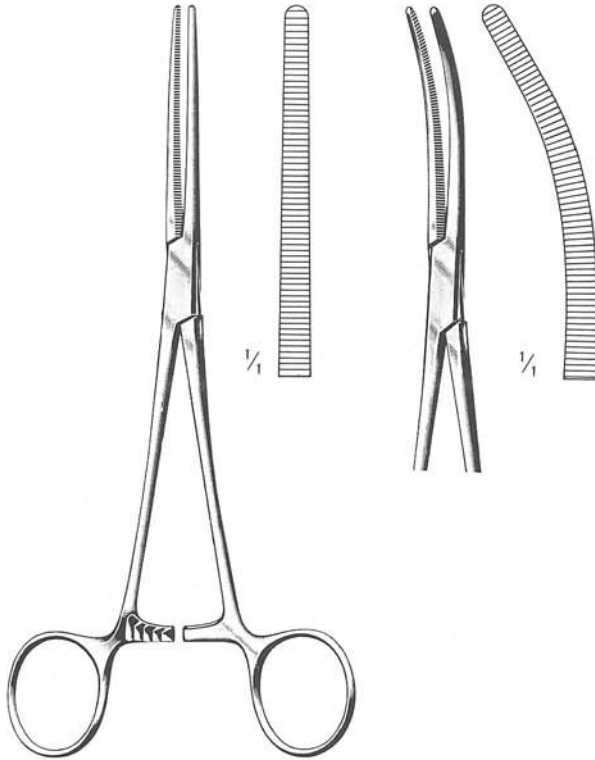

cm	ROCHESTER-PEAN	
13	12.310.13	12.311.13
14	12.310.14	12.311.14
16	12.310.16	12.311.16
18	12.310.18	12.311.18
20	12.310.20	12.311.20
22	12.310.22	12.311.22
24	12.310.24	12.311.24
26	12.310.26	12.311.26
30	12.310.30	12.311.30

ROCHESTER-OSHSNER	
12.320.13	12.321.13
12.320.14	12.321.14
12.320.16	12.321.16
12.320.18	12.321.18
12.320.20	12.321.20
12.320.22	12.321.22
12.320.24	12.321.24
12.320.26	12.321.26
12.320.30	12.321.30



Graziles Modell
 Delicate Model
 Modèle délicat
 Modelo delgado
 Modello delicato

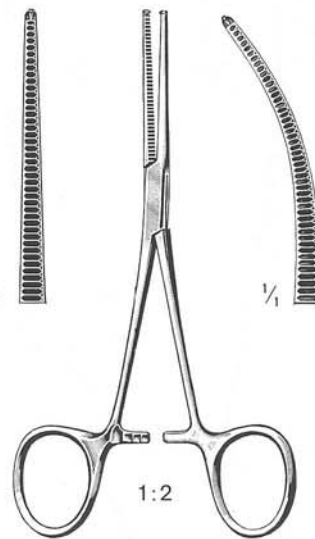

Graziles Modell
 Delicate Model
 Modèle délicat
 Modelo delgado
 Modello delicato

PEAN		
12.312.14	14 cm	12.313.14
12.312.16	16 cm	12.313.16

KOCHER		
12.322.14	14 cm	12.323.14
12.322.16	16 cm	12.323.16

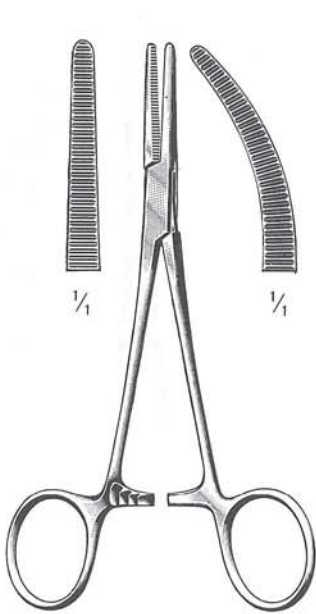

— SPENCER-WELLS —
 12.330.13 13 cm 12.331.13
 12.330.15 15 cm 12.331.15
 12.330.18 18 cm 12.331.18
 12.330.20 20 cm 12.331.20

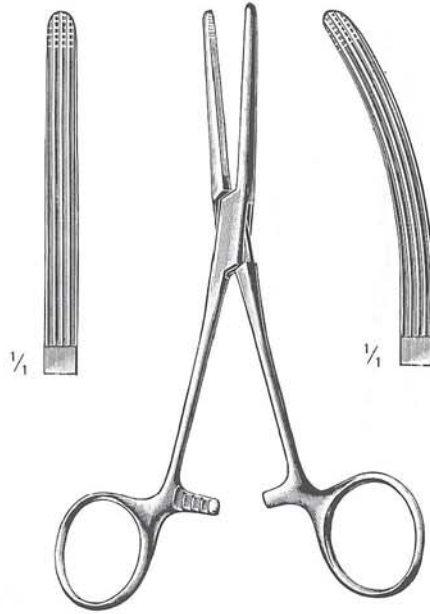

— ROCHESTER-CARMALT —
 12.340.16 16 cm 12.341.16
 12.340.20 20 cm 12.341.20

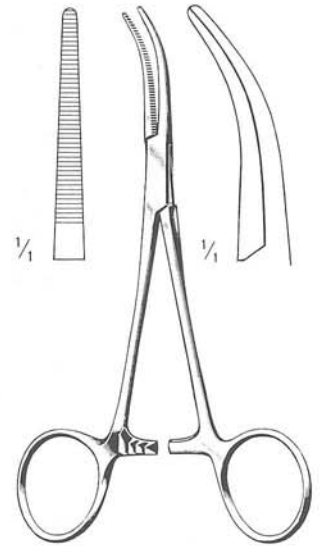

DANDY
 12.345.14
 14 cm

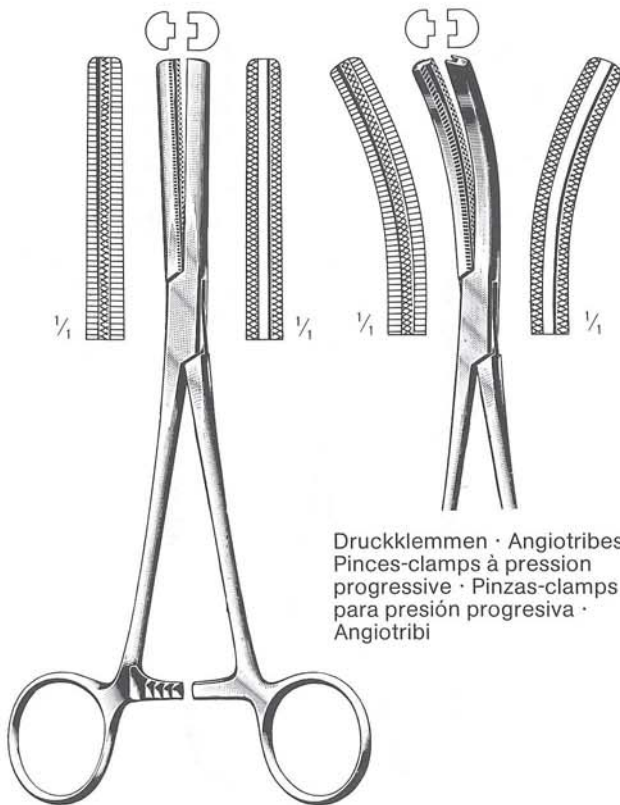

Druckklemmen · Angiotribes
 Pincas-clamps à pression
 progressive · Pinzas-clamps
 para presión progresiva ·
 Angiotribi

— FERGUSSON —
 12.350.16 16 cm 12.351.16
 12.350.20 20 cm 12.351.20

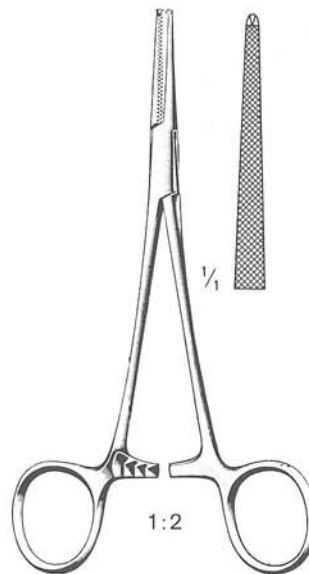

LOVELACE
 12.356.15
 15,5 cm

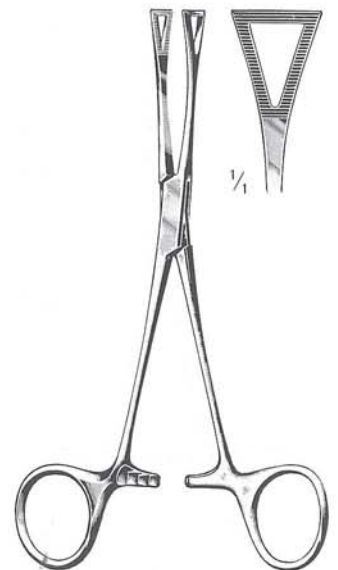

cm PENNINGTON
 15,5 12.358.15
 20,0 12.358.20

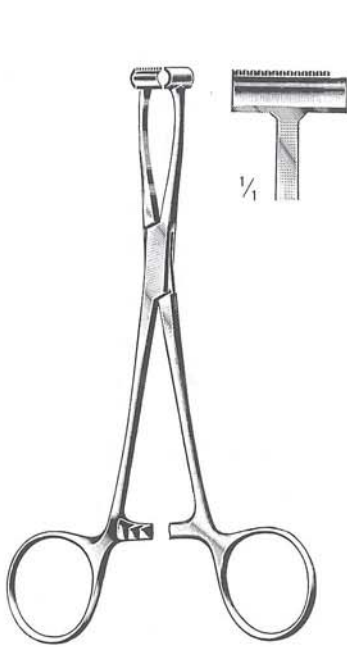

PRATT
 12.360.15
 15 cm

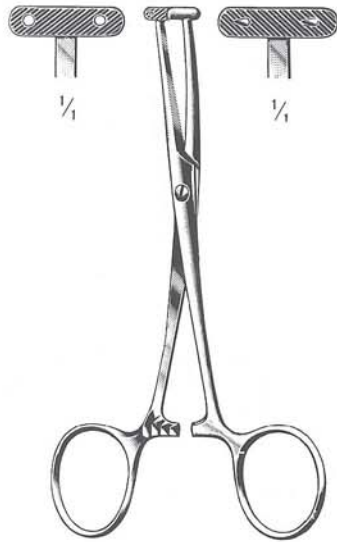

MARTEL
 12.364.14
 14 cm



WILLET-MARTEL
 12.366.19
 19 cm

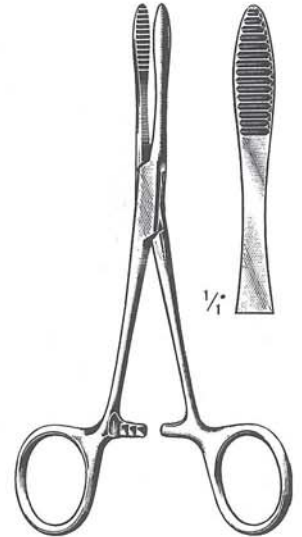

cm	PEAN
14	12.368.14
16	12.368.16

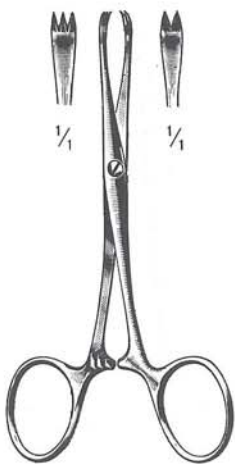

CHAPUT
 12.370.13
 13 cm

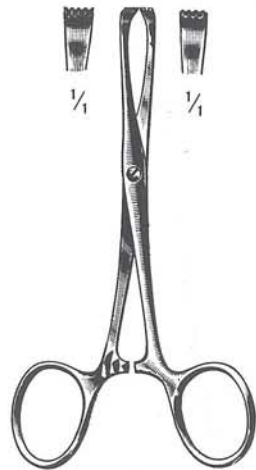

TUFFIER
 12.372.13
 13 cm



COLLIN
 12.374.14
 14 cm



COLLIN
 12.376.16
 16 cm

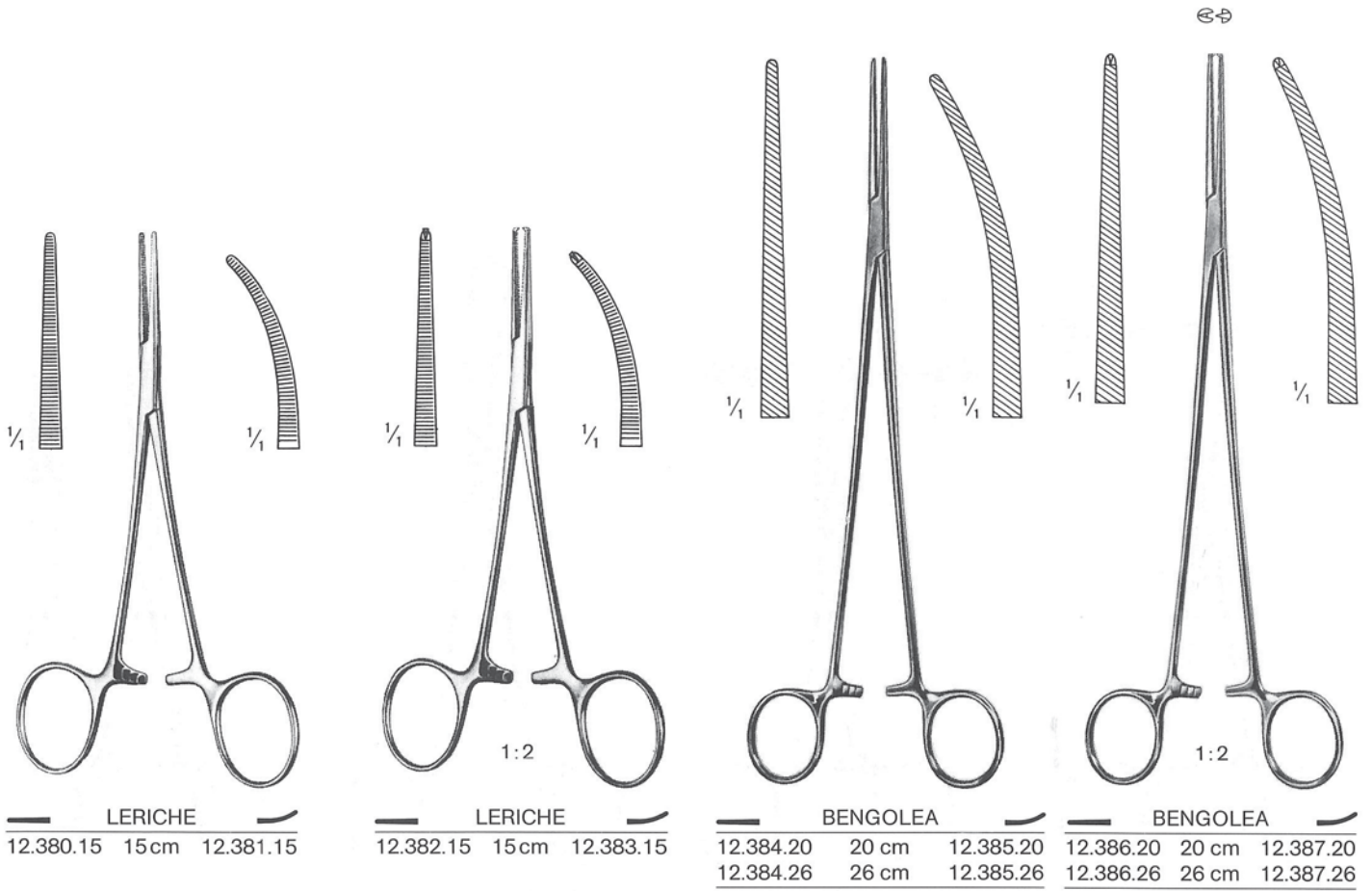

Präparier- und Ligaturklemmen
 Dissecting and Ligature Forceps
 Pincès à dissection et à ligatures
 Pinzas para disección y ligaduras
 Pinze per dissezione e per legature (Passafili)

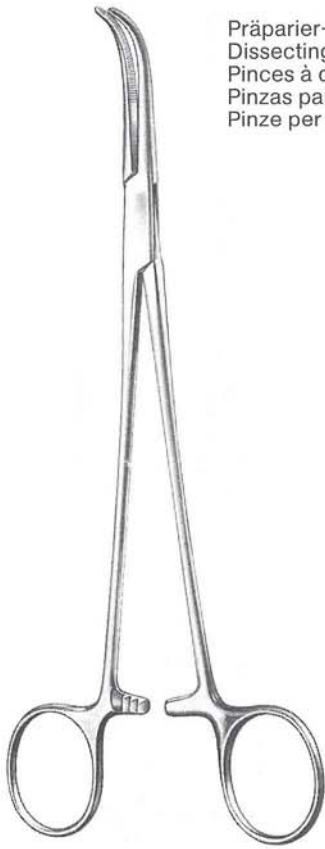

OVERHOLT-GEISSENDOERFER
 12.421.01 - 12.427.07

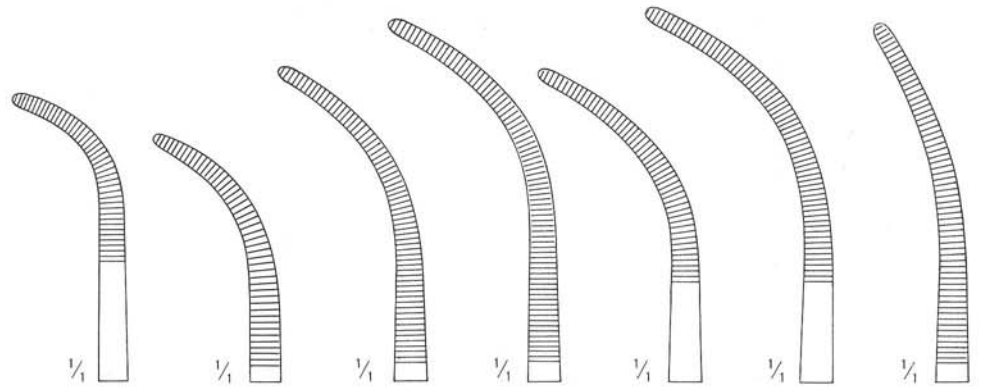

cm	Fig. 1	Fig. 2	Fig. 3	Fig. 4	Fig. 5	Fig. 6	Fig. 7
21	12.421.01	12.421.02	12.421.03	12.421.04	12.421.05	12.421.06	12.421.07
27	12.427.01	12.427.02	12.427.03	12.427.04	12.427.05	12.427.06	12.427.07



GEMINI
 GEMINI mini

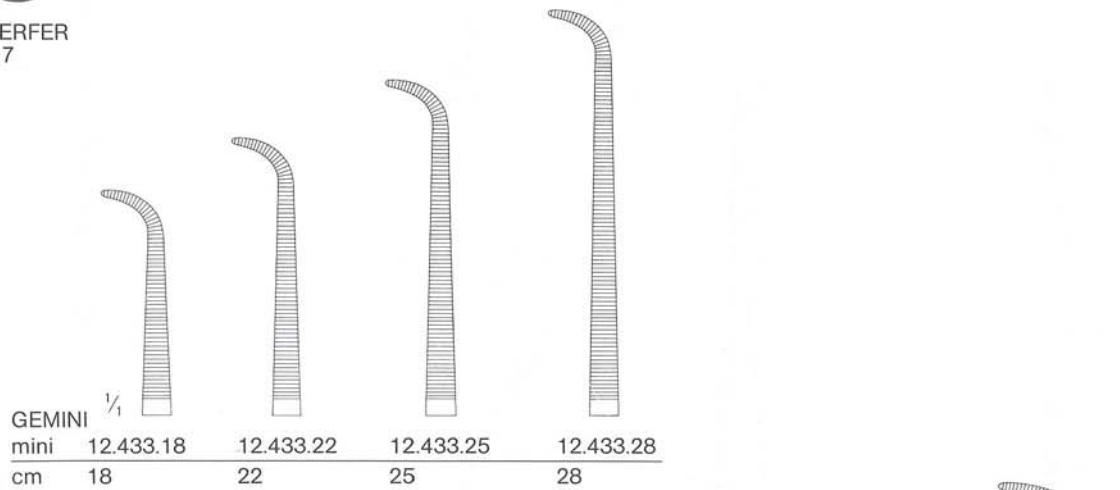

GEMINI mini	12.433.18	12.433.22	12.433.25	12.433.28
cm	18	22	25	28

GEMINI	12.431.13	12.431.16	12.431.18	12.431.20	12.431.23	12.431.25	12.431.28
cm	13 cm	16 cm	18 cm	20 cm	23 cm	25 cm	28 cm

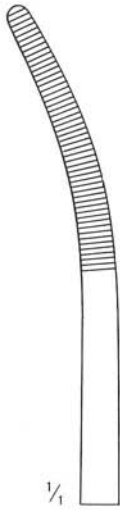

1/1
12.441.01

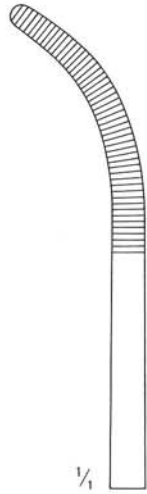

1/1
12.441.02

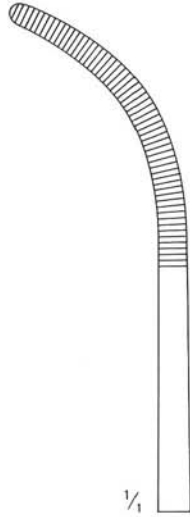

1/1
12.441.03

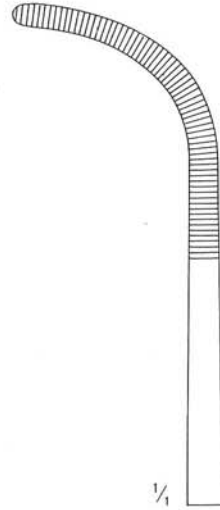

1/1
12.441.04



RUMEL
12.441.01 - 12.441.04
23 cm



1/1
12.442.21 21 cm
12.442.26 26 cm



1/1
21 cm 12.443.21
26 cm 12.443.26



1/1



1/1



1/1 1:2
12.444.21 21 cm
12.444.26 26 cm



1/1 1:2
21 cm 12.445.21
26 cm 12.445.26

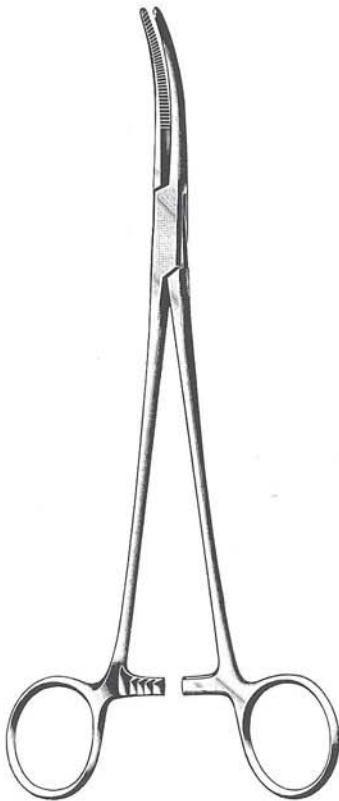

TOENNIS
12.442.21 - 12.445.26
21 cm 26 cm

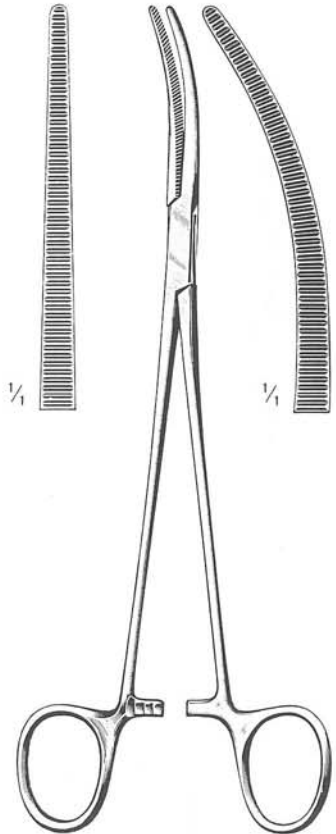

ROBERTS
12.448.22 22 cm 12.449.22

Arterienklemmen
 Hemostatic Forceps
 Pincés hémostatiques
 Pinzas hemostáticas
 Pinze emostatiche

dimeda[®]

SURGICAL INSTRUMENTS

Bronchusklemmen
 Bronchus Forceps
 Pincés-Clamps à Bronches
 Pinzas clamps bronquiales
 Pinze per bronchi

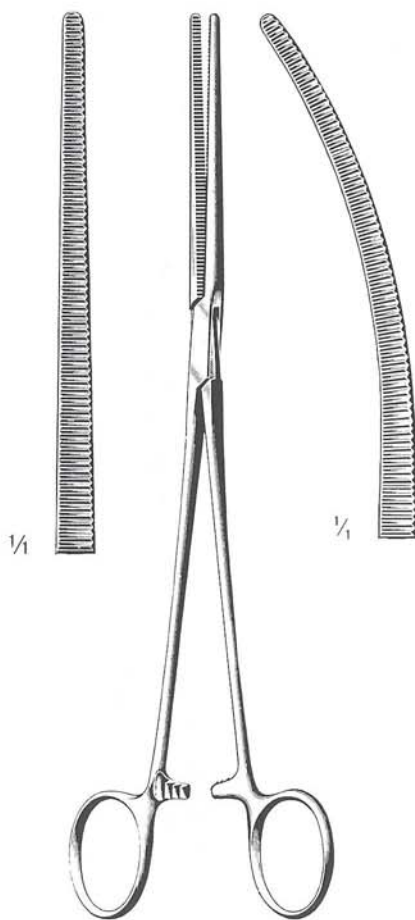

— SAROT —
 12.450.24 24 cm 12.451.24

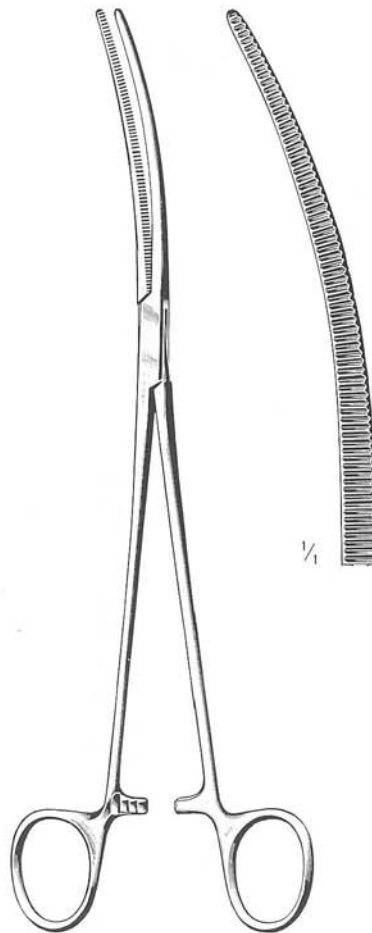

CRAFOORD
 12.453.24
 24 cm

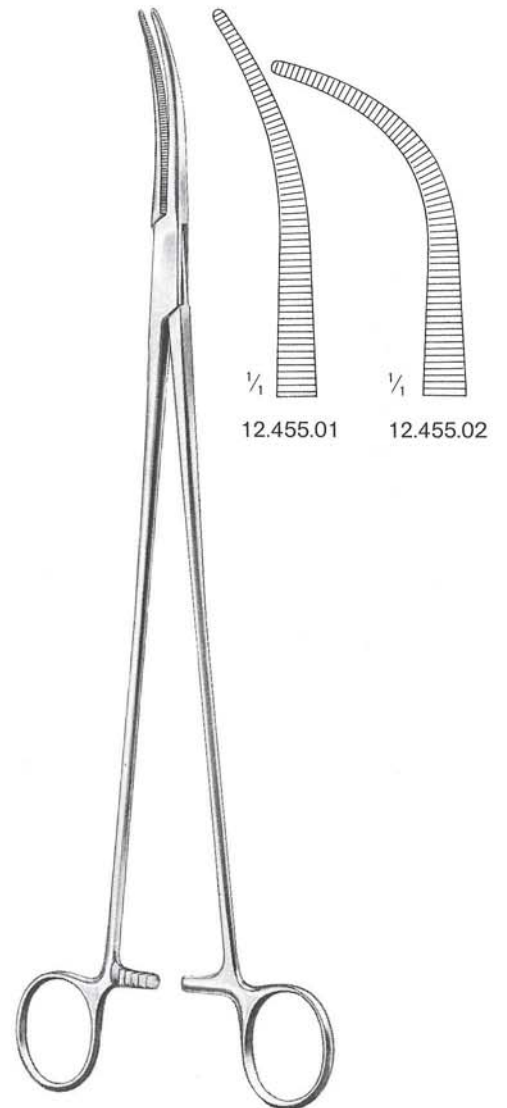

ZENKER
 12.455.01 - 12.455.02
 29,5 cm

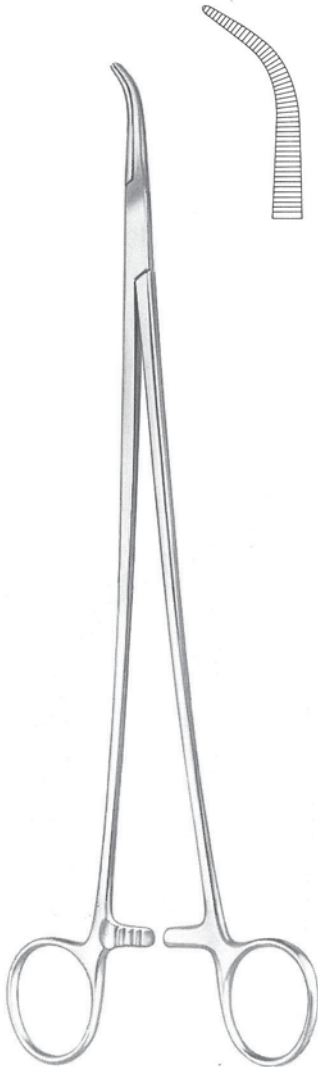

LAWRENCE
 12.457.28
 28 cm



MEEKER
 12.459.28
 28 cm

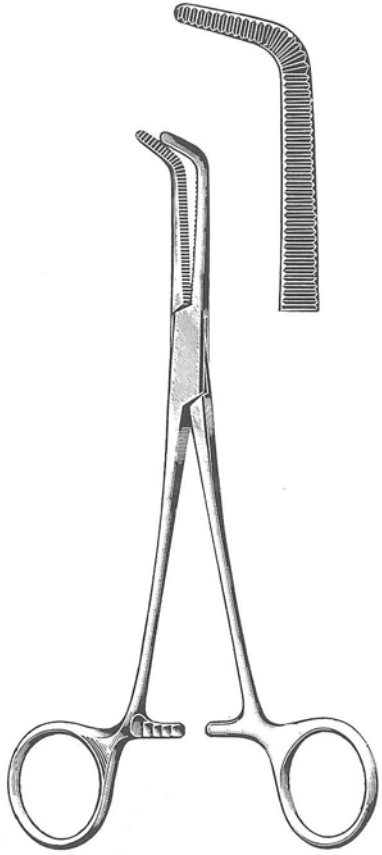

cm	MIXTER
14	12.471.14
16	12.471.16
18	12.471.18
23	12.471.23

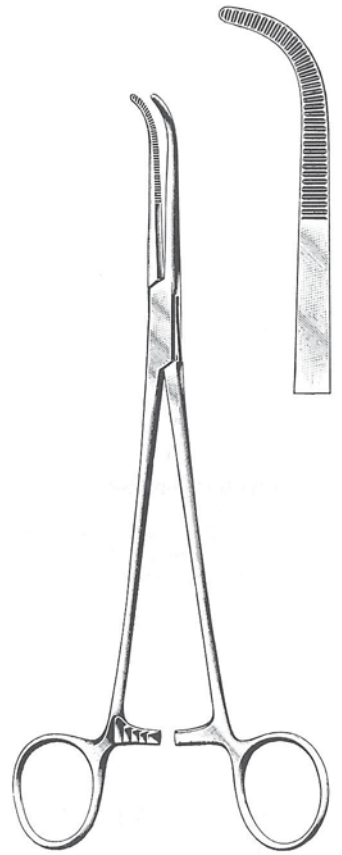

MIXTER
 12.473.22
 22 cm

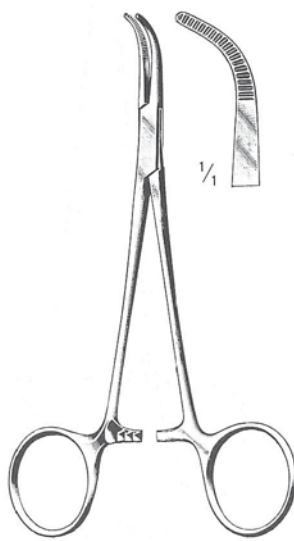

MIXTER Baby
 12.475.14
 14 cm



MIXTER Baby
 12.475.18
 18 cm

Arterien, Gallenkanal, Nierenstiel
 Hemostatic, Gall Duct, and Kidney Pedicle
 Hémostatiques, pédicule rénal et voies biliaires
 Hemostáticas, pedículo renal y vías biliares
 Emostatiche, pedunculo renale e vie biliari

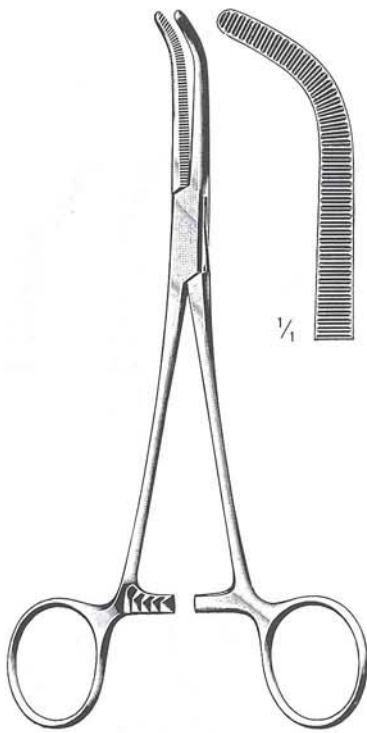

cm	MIXTER-O'SHAUGNESSY
15,5	12.477.15
19,0	12.477.19

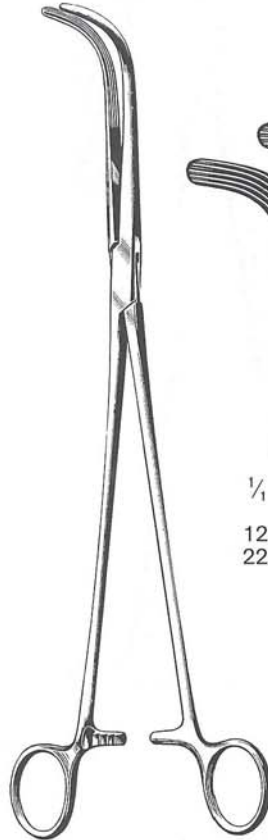

MIXTER
 12.479.22-12.479.28

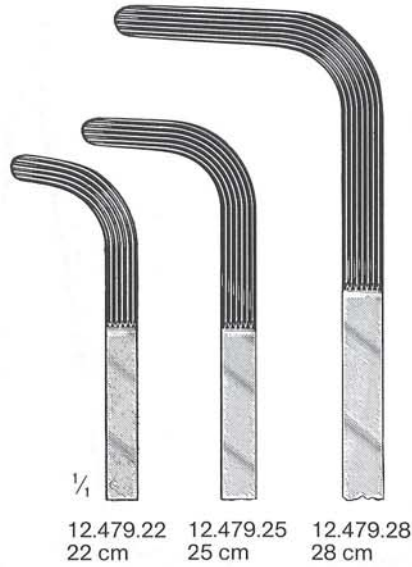

12.479.22	12.479.25	12.479.28
22 cm	25 cm	28 cm

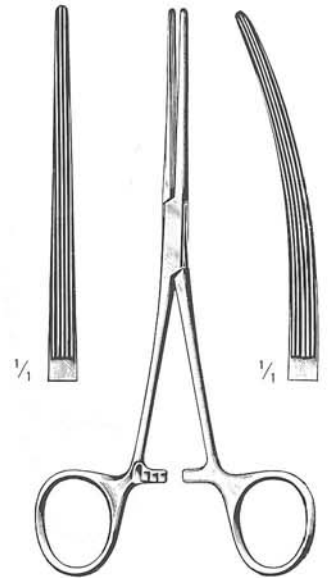

BAINBRIDGE		
12.480.15	15,0 cm	12.481.15
12.480.18	18,5 cm	12.481.18

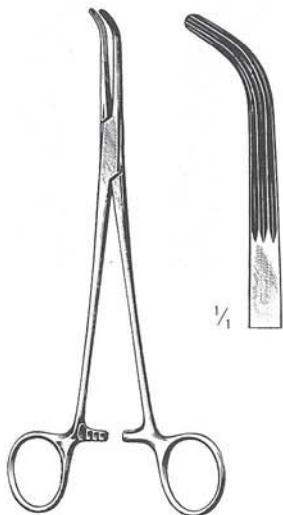

LAHEY
 12.491.19
 19 cm

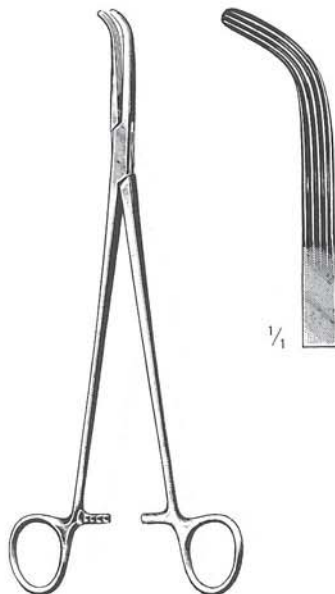

LAHEY
 12.493.23
 23 cm



LOWER
 12.495.18
 18 cm

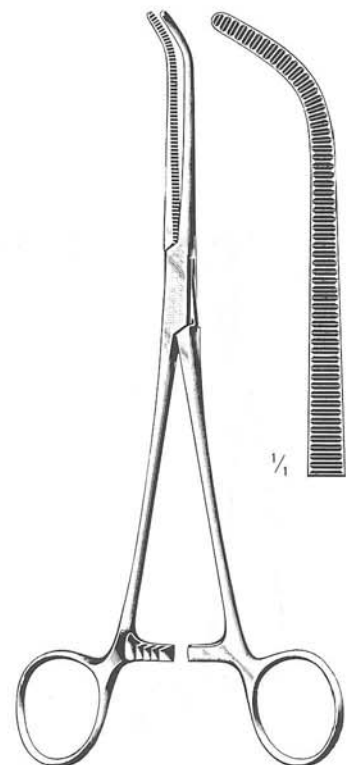

JOHNS-HOPKINS
 12.497.20
 20 cm

Gallenkanal · Gall Duct ·
 Voies biliaires · Vias
 biliaires · Vie biliari



MIXTER
 12.499.16
 16,5 cm

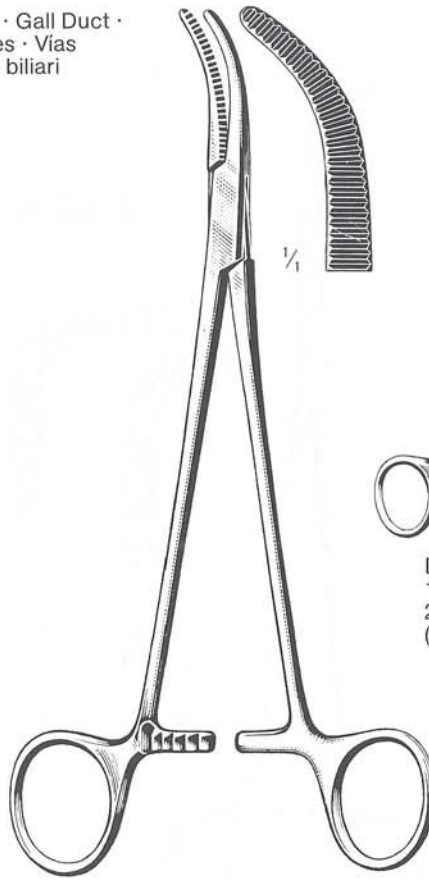

MOYNIHAN
 12.501.23
 23 cm

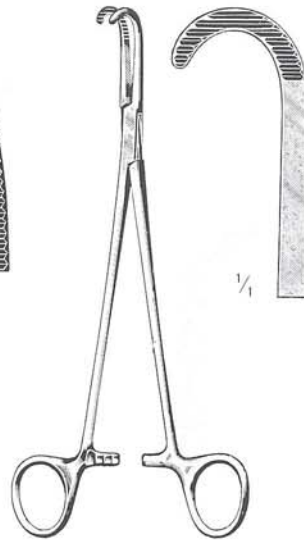

DESJARDINS
 12.503.21
 21 cm
 (Cysticus)

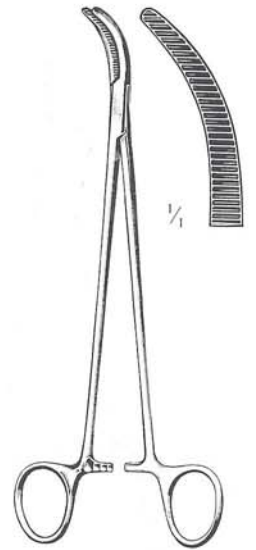

DESJARDINS
 12.505.21
 21 cm



GRAY
 Cholecystectomie
 12.507.22 12.507.23
 22 cm 23 cm

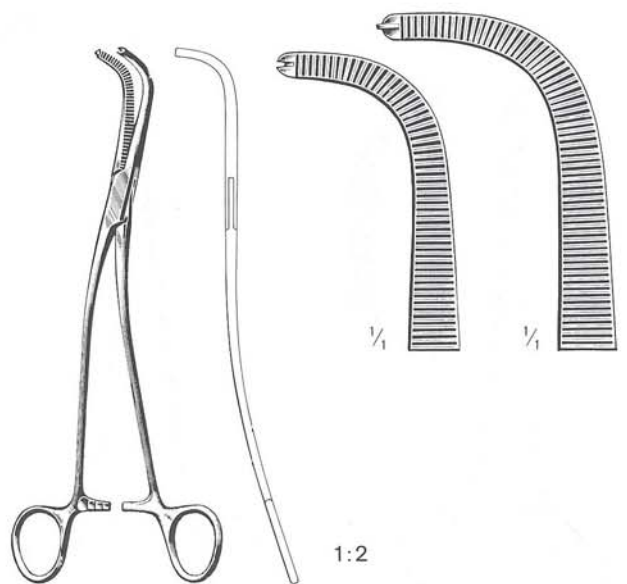

GRAY
 12.509.22 12.509.23
 22 cm 23 cm

Nierenstiel, Gallenkanal
 Kidney Pedicle, Gall Duct
 Pédicule rénal, conduit biliaire
 Pediculo renal, vías biliares
 Pedunculo renale, vie biliari

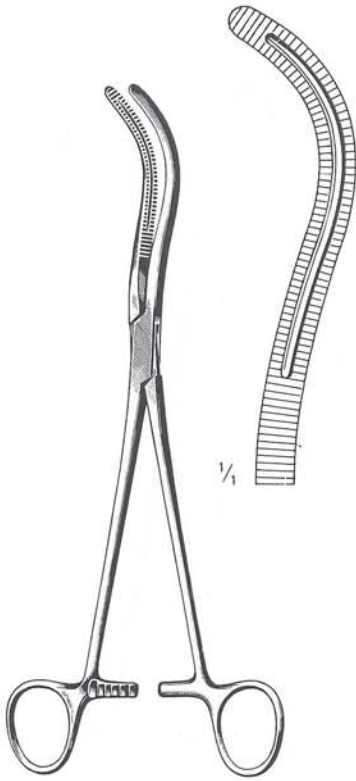

STILLE
 12.513.23
 23 cm

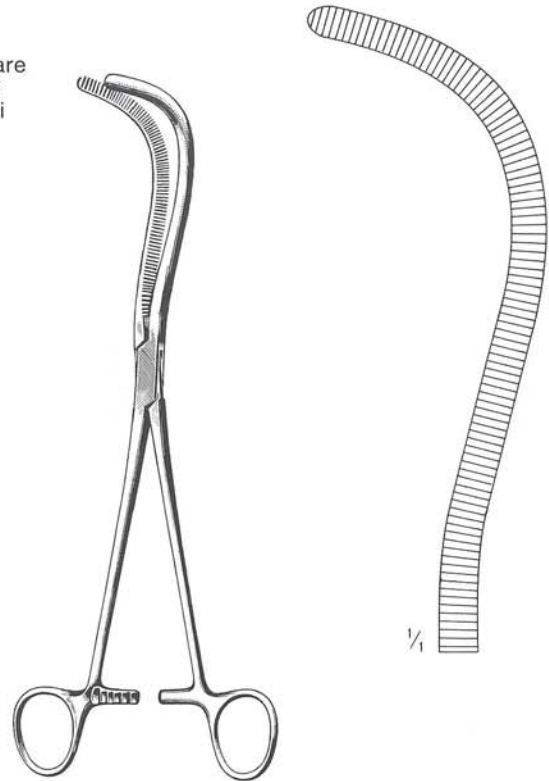

MAYO-GUYON
 12.515.23
 23 cm

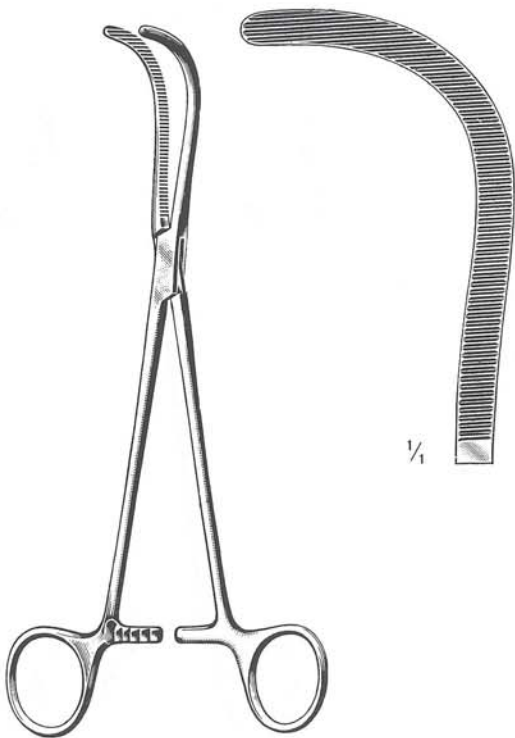

GUYON
 12.517.23
 23 cm

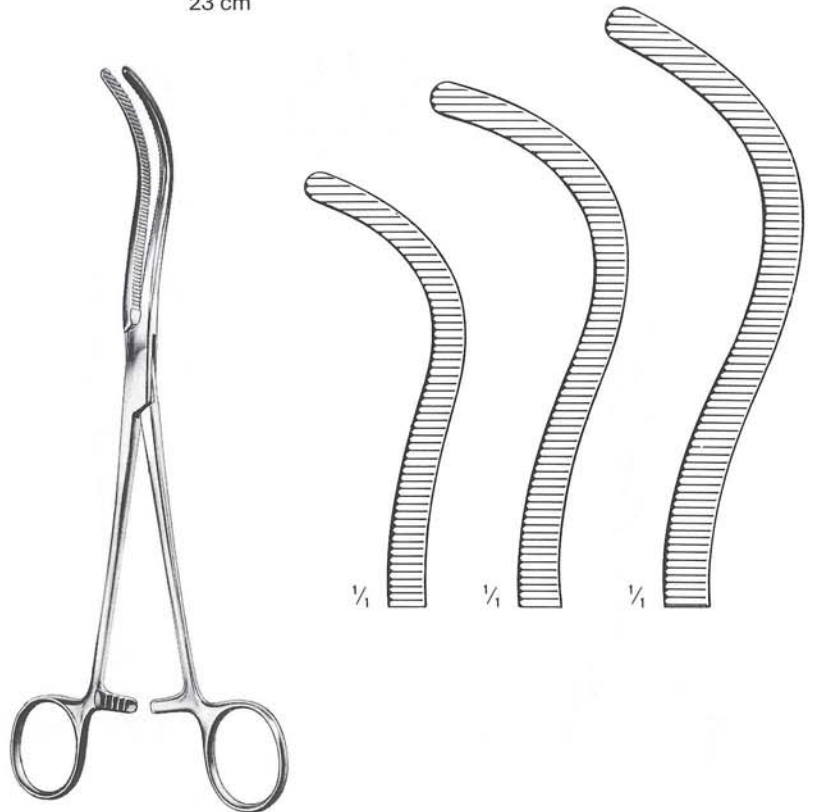

GUYON

12.519.20
 20 cm

12.519.22
 22 cm

12.519.24
 24 cm

Nierenstiel
 Kidney Pedicle
 Pédicule rénal
 Pedículo renal
 Pedunculo renale

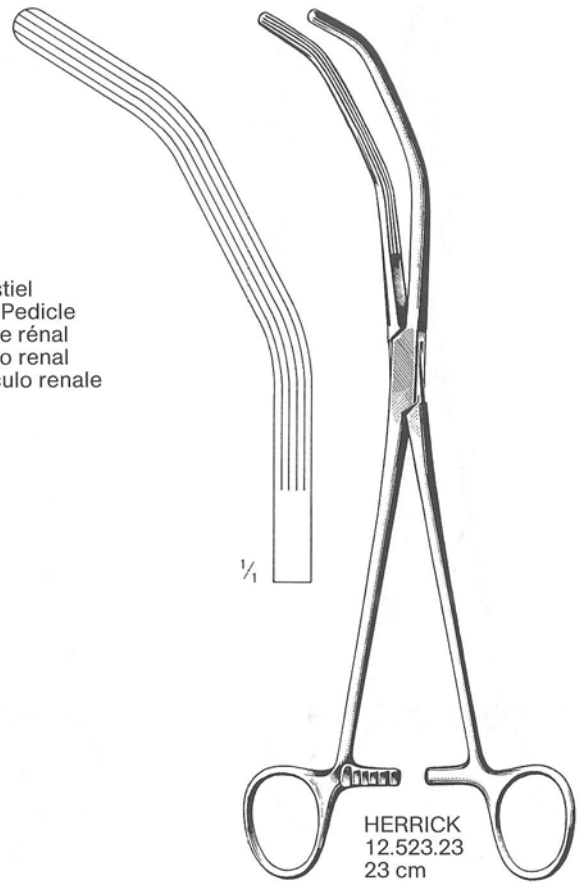

Peritoneum-Klemmen
 Peritoneum Forceps
 Pincès à péritoine
 Pinzas para peritoneo
 Pinze peritoneali

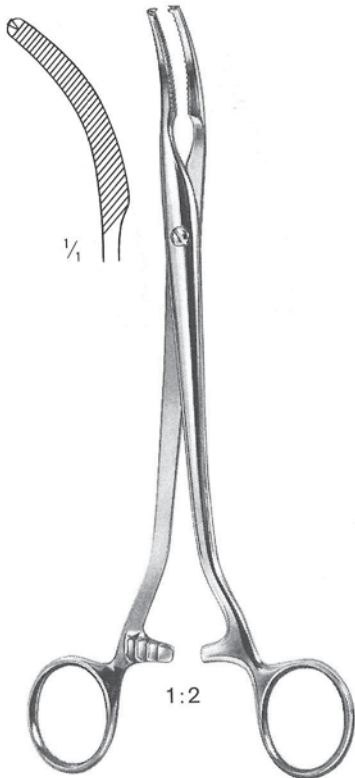

MIKULICZ
 12.551.20
 20 cm

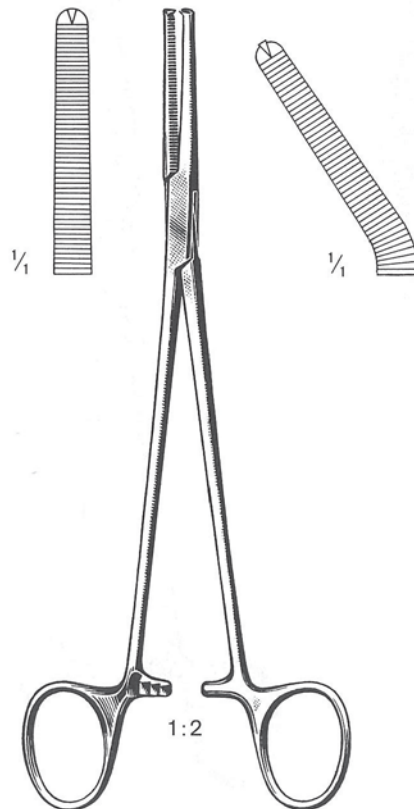

PHANEUF
 12.554.21 21 cm 12.555.21

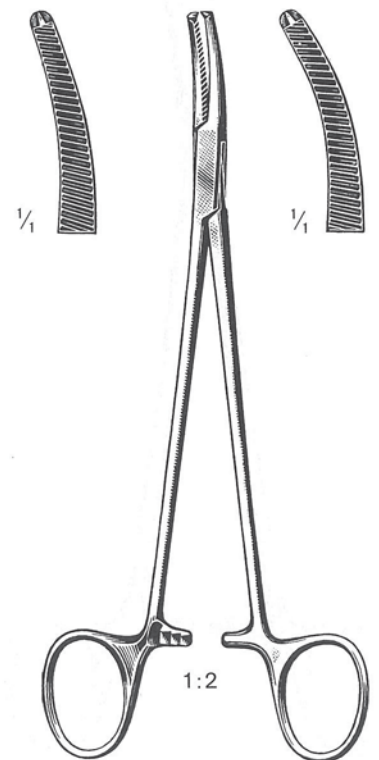

FAURE
 12.561.20 20 cm 12.563.20

Hysterektomie-Klemmen
 Hysterectomy Forceps
 Pincès à hysterectomie
 Pinzas para hysterectomía
 Pinze per isterectomia

dimeda[®]

SURGICAL INSTRUMENTS

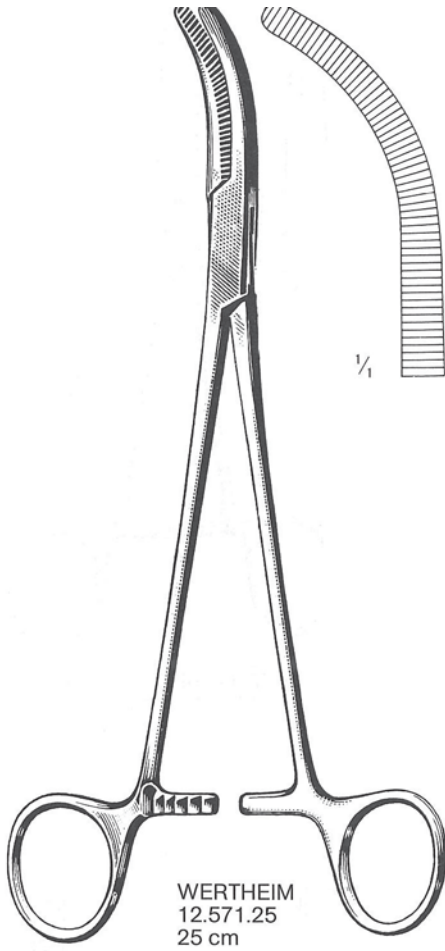

WERTHEIM
 12.571.25
 25 cm

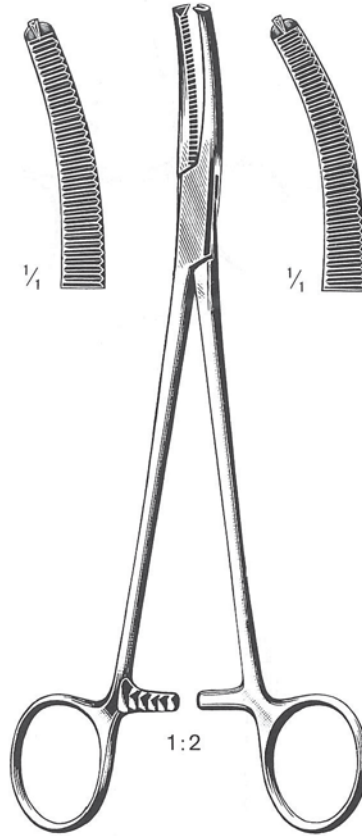

WERTHEIM
 12.573.22 22 cm
 23 cm 12.575.23

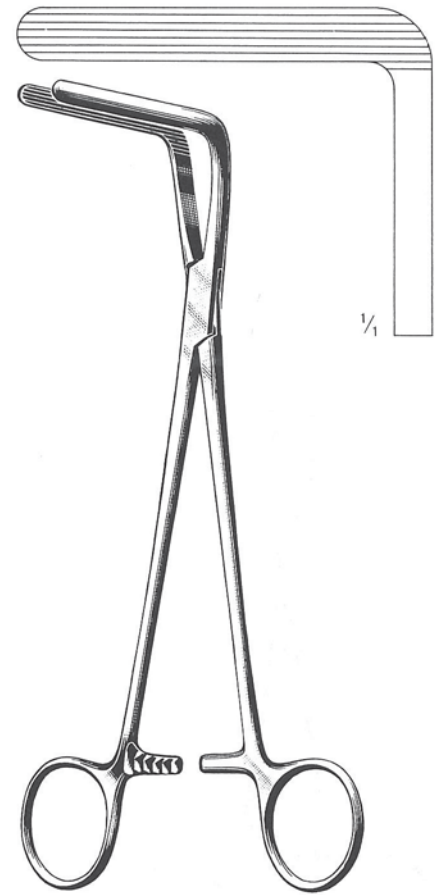

WERTHEIM-CULLEN
 12.579.21
 21,5 cm

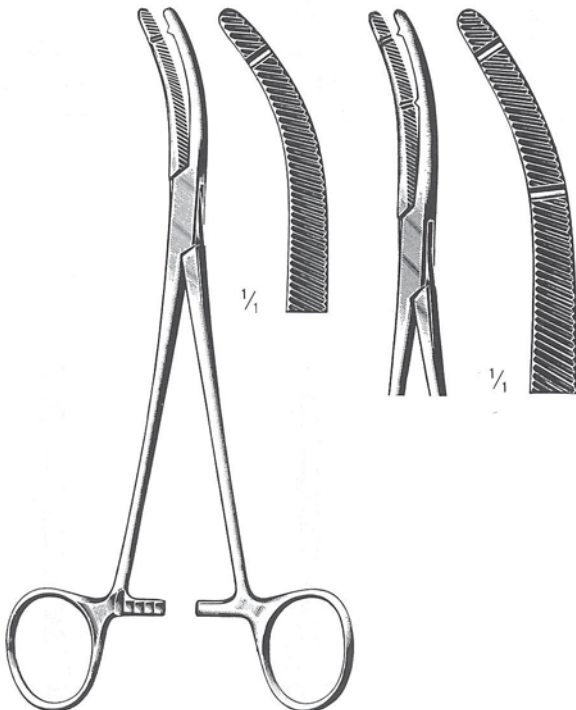

HEANEY
 21,5 cm 12.591.20 12.593.20

Schlauchklemmen
 Tubing Clamps
 Pincas serre-tubes
 Pinzas cierra-tubos
 Pinze serretubi

dimeda[®]

SURGICAL INSTRUMENTS

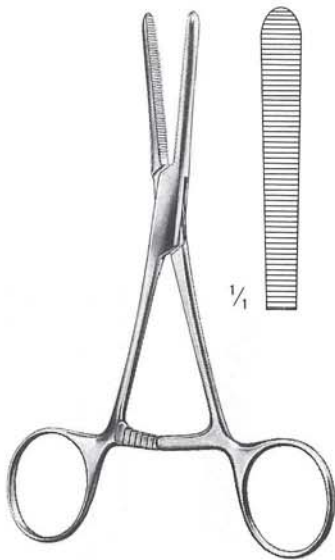

WEISS
 12.702.14
 14,5 cm

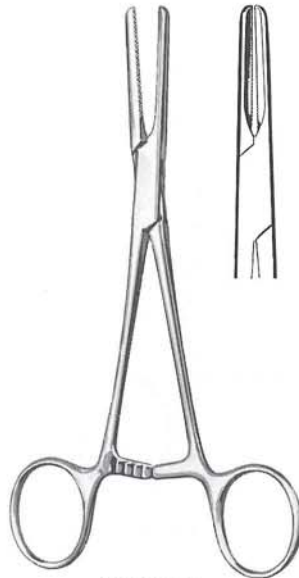

MURPHY
 12.710.15 - 12.710.20



12.710.15
 15 cm



12.710.18
 18 cm



12.710.20
 20 cm

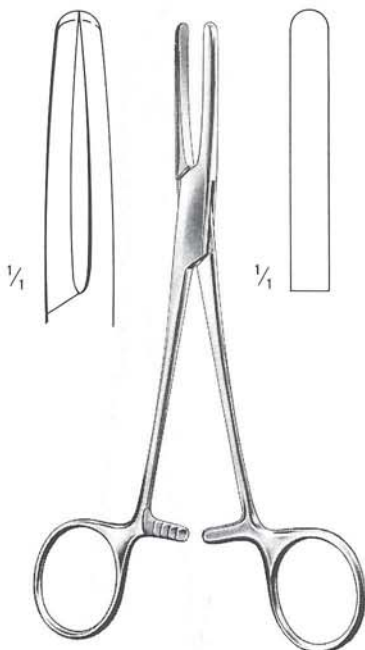

PRESBYTERIAN HOSPITAL
 12.704.16 16 cm
 12.704.18 18 cm



12.712.15-12.712.20

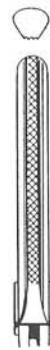

12.712.15
 15 cm



12.712.18
 18 cm

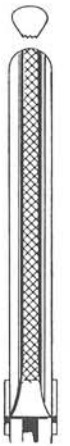

12.712.20
 20 cm

dimeda[®]

SURGICAL INSTRUMENTS