



Cardiovascular-Instrumente  
Cardiovascular Instruments  
Instruments cardiovasculaires  
Instrumentos cardiovasculares  
Strumenti cardiovascolari





Cardiovascular-Instrumente  
Cardiovascular Instruments  
Instruments cardiovasculaires  
Instrumentos cardiovasculares  
Strumenti cardiovascolari

DIMEDA Instrumente GmbH  
Gänsäcker 54 - 58 · D-78532 Tuttlingen  
Tel +49 (0) 7462 9461-0 · Fax +49 (0) 7462 9461-33  
info@dimeda.de · www.dimeda.de



**DE** Im Mittelpunkt aller Maßnahmen und Aktivitäten unseres Hauses steht der Kunde. Ihm gehört unsere ungeteilte Aufmerksamkeit. Seine Wünsche, Ansprüche und Anforderungen sind für uns eine tägliche Herausforderung. Deshalb ist die absolute Kundenorientierung für uns oberstes Prinzip. Sie prägt unsere Geschäftspolitik und ist uns stets ein Ansporn für das Handeln und Denken unserer Mitarbeiter. Seit 1976 sind wir erfolgreich in der Medizinbranche tätig und wir möchten dies auch in der Zukunft sein. Deshalb haben wir uns bereits heute für morgen gerüstet. Mit der Optimierung des Bewährten, mit innovativen Produktbereichen und Produktfamilien, mit modernisierten und aktualisierten Verfahrensabläufen, mit neuen Gedanken und engagierter Einsatzfreude. Davon möchten wir Sie überzeugen.

**EN** The center of all our activities is the customer. They are our aim and deserve our unlimited attention. Their wishes, demands and requirements are our day to day challenge. Therefore, customer service is our number one priority. It effects our business policy and is a permanent task for every member of the DIMEDA team. Since 1976, DIMEDA has successfully distributed high quality medical products and we intend to continue with our high standards in the future. In order to do so, we are preparing ourselves today for the demands of the future. This means a permanent optimization of standards, establishment of innovative products, introduction of modern processes, realization of innovative developments and motivation of people and customers. We would like you, the customer, to know how serious and dedicated we are to you.

**FR** Le client est au centre de toutes les opérations et activités de notre maison. C'est sur lui que se porte notre entière attention. Ses souhaits, demandes et exigences sont pour nous un défi quotidien. C'est pourquoi nous avons pour principe suprême une orientation totale vers le client. Cette orientation marque fortement notre politique commerciale, nous pousse à agir et à penser à celui que nous considérons comme "collaborateur". Depuis 1976, nous évoluons avec succès dans le secteur médical et nous aimerions faire de même dans le futur. C'est pourquoi dès aujourd'hui nous nous sommes préparés à demain tout d'abord en optimisant l'existant, en innovant ensuite notre gamme de produits, en modernisant et en actualisant les procédés de fabrication, avec des idées nouvelles, une vraie joie d'entreprendre. Nous voudrions vous en convaincre.

**ES** El objetivo de nuestras actividades y esfuerzos es la satisfacción de nuestros clientes. A ellos dedicamos toda nuestra atención. Sus deseos, demandas y requerimientos constituyen nuestro reto diario. Por eso, el servicio al cliente es la premisa de nuestras actividades, marca nuestra política empresarial y representa un constante estímulo en las tareas de todos los empleados de DIMEDA. Desde 1976 trabajamos con éxito en la distribución de productos médicos y nuestro firme propósito es superar este éxito. Por ello, nos hemos preparado ya para el día de mañana. Optimizamos estándares acreditados, establecemos productos innovativos, introducimos procesos modernos y nuevas ideas con personal motivado y comprometido. ¡Déjenos convencerles!

**IT** Al centro delle nostre attività e del nostro impegno c'è il cliente. A lui dedichiamo tutta la nostra attenzione. Soddisfare le sue richieste, le sue aspettative e i suoi desideri è per noi una sfida quotidiana. Dare priorità assoluta alle esigenze del cliente è conseguentemente la nostra regola principale. Essa caratterizza la nostra politica aziendale e rappresenta un riferimento costante per programmi e azioni di tutti i collaboratori di DIMEDA. Dal 1976 lavoriamo con successo nel campo dei prodotti medicali e vorremmo continuare a farlo anche per il futuro. Futuro che già oggi stiamo preparando con il costante miglioramento dei prodotti già sperimentati, con la messa a punto di nuovi gruppi di prodotti e di nuovi campi di impiego con la revisione e la modernizzazione delle procedure, con la passione, la competenza, l'esperienza, l'impegno e le idee innovative dei nostri collaboratori. Vorremmo potervi vincere di tutto ciò con i fatti.







**DE** Unsere Produktpalette enthält über 15.000 verschiedene Standardinstrumente für das gesamte Feld der Human-, Dental-, und Veterinär-Medizin. Besondere Schwerpunkte sind die allgemeine Chirurgie, die Orthopädie und Osteosynthese, die Neurochirurgie, Ophthalmologie und HNO, die Endoskopie, die Urologie und die Gynäkologie, sowie weitere verwandte Produktgruppen. Durch die enge Zusammenarbeit mit unseren Kunden, Praktikern und Wissenschaftlern im In- und Ausland wird das gesamte Lieferprogramm ständig erweitert, ergänzt und auf den neuesten Stand der Technik und den Bedürfnissen und Erfordernissen des Marktes angepasst.

**EN** Our product range covers more than 15.000 different Standard-Instruments for all fields of human, dental and veterinarian applications. Especially General Surgery, Orthopedics and Osteosynthesis, Neurosurgery, Ophthalmology and ENT, Endoscopy, Urology and OB/GYN as well as other related areas are our expertise. Close relationship and cooperation with our customers, surgeons, and scientists worldwide guarantees that our product range is permanently updated, expanded and on the edge of technical developments. This allows DIMEDA to be the frontrunner for the demands of the world market.

**FR** Notre gamme de produits contient plus de 15.000 instruments standards à la fois pour la médecine humaine et animale ainsi que pour le dentaire. Nos points forts sont la chirurgie générale, l'orthopédie, l'ostéosynthèse, la neurochirurgie, l'ophtalmologie, l'ORL, l'endoscopie, l'urologie et la gynécologie, ainsi que les groupes de produits apparentés. Grâce à l'étroite collaboration entre nos clients, médecins, scientifiques en Allemagne ou à l'étranger, nous développons et complétons constamment notre éventail de références et nous nous adaptons aux nouvelles techniques, aux besoins et aux exigences du marché.

**ES** Nuestra gama de productos abarca más de 15.000 diferentes artículos estándares para todos los campos de la medicina humana y veterinaria. Nuestros campos de mayor concentración son especialmente los sectores de la odontología, cirugía general, ortopedia y osteosíntesis, neurocirugía, oftalmología y otorrinolaringología, la endoscopia, urología y ginecología así como otros campos relacionados. A través de estrechas relaciones con nuestros clientes, cirujanos, y científicos en todo el mundo, actualizamos y ampliamos constantemente nuestra gama de productos adaptándola a las necesidades del mercado.

**IT** Il nostro catalogo comprende oltre 15.000 strumenti standard specifici per ogni campo della medicina umana, dentale e veterinaria. I nostri settori principali sono: chirurgia generale, chirurgia ossea, neurochirurgia, oftalmologia, O.R.L., endoscopia, urologia, ginecologia e gruppi di prodotti collegati a questi. In stretta collaborazione con clienti, esperti e scienziati di tutto il mondo stiamo continuamente ampliando e completando la nostra offerta adattandola allo stato dell'arte, e ai bisogni e alle richieste del mercato.





**DE** Alle Instrumente und Geräte aus unserem Sortiment werden von geschulten und erfahrenen Fachkräften mit handwerklichem Geschick und dem Einsatz modernster Maschinen und Anlagen hergestellt. Dabei kommen nur Materialien zum Einsatz, die den allgemeinen Vorschriften sowie unseren besonders hohen Qualitätsstandards genügen. Unser Qualitätsmanagement ist keine leere Worthülse. Es ist ein wichtiger Bestandteil unserer langfristigen Unternehmensstrategie, in die jeder einzelne Mitarbeiter eingebunden ist und die von einem Wir-Gefühl getragen wird. Unabhängig vom jeweiligen Arbeitsplatz fühlt sich jeder für die Einhaltung der Qualität verantwortlich und handelt danach. Konsequente Produkt- und Verfahrensprüfungen gewährleisten einen gleichbleibend hohen Qualitäts-Standard und sind somit wichtige Grundlage für unser weiteres Wachstum. Die Zertifizierungen nach ISO 9001 und EN 46001 sind für uns genauso selbstverständliche Rahmenbedingungen wie die MPG- und GMP-Konformität.

**EN** All Instruments and devices are manufactured and checked by trained and experienced personnel, using state of the art machines and technologies. Only materials that meet the general requirements for medical devices and our own high level specifications are used. Our quality management system is not just a word or document. It is a very important part of our long term business plan. Every employee of DIMEDA is incorporated into this philosophy. The feeling of "WE" as DIMEDA holds them responsible for the quality, no matter what their function is. Permanent product and system audits guarantee a continuously high level quality standard and are the basis for our further growth and development. Certification according to ISO 9001, EN 46001 and MDD is standard. GMP (Good Manufacturing Practices) in accordance with the FDA are continually followed and updated.

**FR** Tous nos instruments et appareils sont fabriqués par une main d'oeuvre formée et expérimentée, faisant preuve d'un savoir-faire artisanal associé aux machines et aux installations les plus modernes. Il va de soi que pour un résultat optimal, nous utilisons seulement des matériaux qui satisfont la réglementation générale et répondent à des standards de qualité particulièrement élevés. Notre management de la qualité n'est pas un vain mot. Il est au contraire un composant essentiel de notre stratégie d'entreprise à long terme, dans laquelle chaque collaborateur est impliqué et qui est marquée par un fort sentiment d'appartenance. Chacun se sent responsable et chacun agit pour le respect des normes de qualité, et ce, quelque

soit le poste de travail. Les contrôles des produits et des procédés de fabrication garantissent un niveau élevé de qualité toujours égal et ils sont aussi la base de notre croissance continue. Les conditions préalables à la réussite de notre management qualité sont bien évidemment d'être certifiés ISO 9001 et EN 46001 et de se conformer au GMP (good manufacturing practice) et MPG.

**ES** Todos nuestros productos son fabricados por personal especializado y experto con máquinas e instalaciones modernas. En la fabricación sólo se utilizan materiales que cumplen las normas vigentes para instrumental médico y nuestras propias especificaciones de alta calidad. Nuestro sistema de control de calidad no es un concepto vacío. Este sistema constituye un pilar de nuestra estrategia comercial. Todos y cada uno de los empleados de DIMEDA se identifican con esta filosofía; cualquiera que sea su función en la empresa, todos se sienten responsables de su aplicación. Los controles permanentes de los productos y de los sistemas garantizan un alto nivel constante de calidad y son la base de nuestro crecimiento. La certificación según ISO 9001 y EN46001 constituye algo tan natural para nosotros como el cumplimiento de las normas MPG y GMP.

**IT** Tutti gli strumenti ed apparecchi del nostro assortimento vengono fabbricati da tecnici istruiti ed addestrati dotati di provata esperienza e con l'uso delle più moderne macchine ed attrezzature. Per la produzione vengono utilizzati solo materiali di alta qualità conformi alle norme vigenti ed ai nostri standards di qualità particolarmente restrittivi. Per noi "Sistema di Gestione della Qualità" non è una espressione vuota, ma l'elemento centrale nella strategia della nostra impresa. Ogni collaboratore, indipendentemente dalla funzione svolta, si identifica con la nostra filosofia, si sente responsabile della qualità dei nostri prodotti e agisce di conseguenza. Controlli sistematici su processi di produzione e sui prodotti assicurano il mantenimento di un alto livello di qualità e sono la base per il nostro miglioramento continuo. Ovviamente la certificazione del sistema qualità secondo le norme ISO 9001 e EN 46001 e la conformità alle norme MPG e GMP sono requisiti necessari.







**DE** Die kundenorientierte Lagerhaltung und die Lieferzeiten unterliegen einem ständigen Optimierungsprozess, um stets flexibel und unbürokratisch die unterschiedlichsten Wünsche unserer Kunden zu erfüllen. Das moderne Logistikzentrum mit großzügigem, computergestütztem Hochregallager gestattet die Übergabe der Kundenaufträge an die vorbestimmten Speditionen in kürzester Zeit. Ob auf der Straße, per Bahn, per Schiff oder mit dem Flugzeug, unsere Ware erreicht unsere Kunden in der ganzen Welt.

Artikel, die nicht lagermäßig vorrätig sind, können durch einen speziellen Service sehr kurzfristig zur Verfügung gestellt und zum Versand gebracht werden. Sonderanfertigungen, Sonder-Ätzungen oder zusätzliche Beschriftungen bestimmter Produkte sind durch unsere sprichwörtliche Flexibilität problemlos möglich.

**EN** Our customer oriented inventory system, the reduction of lead times are permanently subject to restructuring and improving. We do this in order to be able to react in a flexible and timely manner to the demands of our customers. Our modern, fully computerized Logistics Center allows us to deliver the products to the forwarders within a very short period of time. No matter if by car, train, ship or airplane, the shipments will reach their destinations in a timely manner worldwide.

Products that are not in stock can be supplied on customers request within a short period of time. Special items, etchings or additional labelling is part of our flexibility, upon request.

**FR** Une tenue de stock pensée pour le client, des délais de livraison rapides servent de base à un processus d'optimisation constant dans le but de satisfaire les différents besoins de nos clients, de manière toujours flexible, et ignorant toute bureaucratie. Notre centre logistique, moderne, totalement informatisé, équipé de rayonnages sur toute sa hauteur nous permet de remettre aux transporteurs les commandes de nos clients dans les plus brefs délais. Que ce soit par camion, train, bateau, ou encore par avion, notre marchandise parvient à nos clients partout dans le monde.

Les articles qui ne sont pas tous suffisamment en stock peuvent être mis à disposition par un service spécial et expédiés très rapidement. Notre devise est de faire preuve d'une grande flexibilité, toute fabrication spéciale, gravage ou inscription supplémentaire sur certains produits peuvent être réalisés sans aucun problème.

**ES** Nuestro stock se adapta a las necesidades del mercado y la rapidez de entrega es constantemente optimizada para ser flexibles y cumplir los diferentes deseos de nuestros clientes. Nuestro centro logístico moderno, con almacenes de estanterías elevadas dirigido por ordenador, nos permite entregar en corto plazo los pedidos de nuestros clientes a los correspondientes transportistas. Nuestros productos llegan a nuestros clientes en todo el mundo por carretera, por tren, en barco o en avión.

Gracias a un servicio especial, los artículos que no se encuentran en stock, pueden ser entregados en corto plazo. Gracias a nuestra proverbial flexibilidad, hacemos posible el suministro de artículos de fabricación especial, marcación y características individuales según las indicaciones del cliente o provistos de etiquetado especial.

**IT** L'organizzazione orientata al cliente del nostro magazzino e la velocità di consegna sono oggetto di un processo di miglioramento continuo con l'obiettivo di soddisfare in modo flessibile e non burocratico le più varie esigenze dei nostri clienti. Il nostro moderno centro logistico, dotato di scaffalature servite da computer, è gestito con le tecniche più moderne e permette una rapidissima evasione degli ordini. Sia che viaggino su strada che su rotaia, sia per mezzo aereo che per nave i nostri prodotti raggiungono i nostri clienti in ogni parti del mondo.

Grazie ad un servizio speciale gli articoli non disponibili a magazzino sono comunque ottenibili e consegnabili in breve tempo. La nostra proverbiale flessibilità ci permette di soddisfare esigenze particolari con esecuzioni speciali nonché con marcature e scritte personalizzate.



— Gerades Instrument  
Straight Instrument  
Instrument droit  
Instrumento recto  
Strumenoi retto

**10.256.15** Mit TC-Einsätzen  
TC Lined  
A mors TC  
Con bocas TC  
Con morso TC

⤿ Gebogenes Instrument  
Curved Instrument  
Instrument courbe  
Instrumento curvo  
Strumento curvo







**08.104.14** TC Schneiden  
TC Cutting Edges  
Tranchant TC  
Filos de corte TC  
Taglio TC

▶ Scharfes Instrument  
Sharp Instrument  
Instrument pointu  
Instrumento agudo  
Strumento acuto

**11.300.16** Titan  
Titanium  
Titane  
Titanio  
Titanio

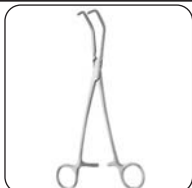
— Stumpfes Instrument  
Blunt Instrument  
Instrument mousse  
Instrumento romo  
Strumento smusso

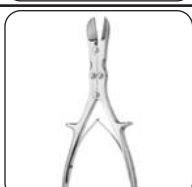

Saugrohre Suction Tubes Tubes d'aspiration Tubos de aspiración Tubi d'aspirazione	<b>04, 22, 40</b> 1 - 6	
Skalpelle, Messer, Aortastanzen Scalpels, Knives, Aortic Punches Bistouris, Couteaux, Rongeurs pour aorte Bisturías, Cuchillos, Perforadores aórticos Bistrui, Coltelli, Pinze taglianti per aorta	<b>06</b> 7 - 16	
Scheren Scissors Ciseaux Tijeras Forbici	<b>07, 08, 09</b> 17 - 36	
Pinzetten & Klemmen Forceps Pinces Pinzas Pinze	<b>10, 11, 12, 13, 14, 16, 56</b> 37 - 156	
Wundhaken Retractors Ecarteurs Separadores Divaricatori	<b>18</b> 157 - 182	
Nadelhalter Needle Holders Porte-aiguilles Porta-agujas Port'aghi	<b>24</b> 183 - 190	
Orthopädie, Osteosynthese Bone Surgery, Osteosynthesis Chirurgie osseuse, Ostéosynthèse Cirugía ósea, Osteosíntesis Chirurgia ossea, Osteosintesi	<b>32, 33, 56</b> 191 - 220	
Rippensperrer Rib Spreaders Ecarteurs des côtes Separadores costales Divaricatori costali	<b>56</b> 221 - 246	
Sonden, Dilatatoren Probes, Dilators Sondes, Dilatateurs Sondas, Dilatadores Sonde, Dilatatori	<b>20, 22, 56</b> 247 - 258	

Inhaltübersicht  
Table of Contents  
Table des Matières  
Tabla del contenido  
Indice delle sezioni

*dimeda*<sup>®</sup>

SURGICAL INSTRUMENTS

---

Inhaltsverzeichnis  
Index  
Index  
Indice alfabético  
Indice

259 - 280

---

Nummernverzeichnis  
Numerical Index  
Index Numérique  
Índice Numérico  
Indice Numerico

281 - 288

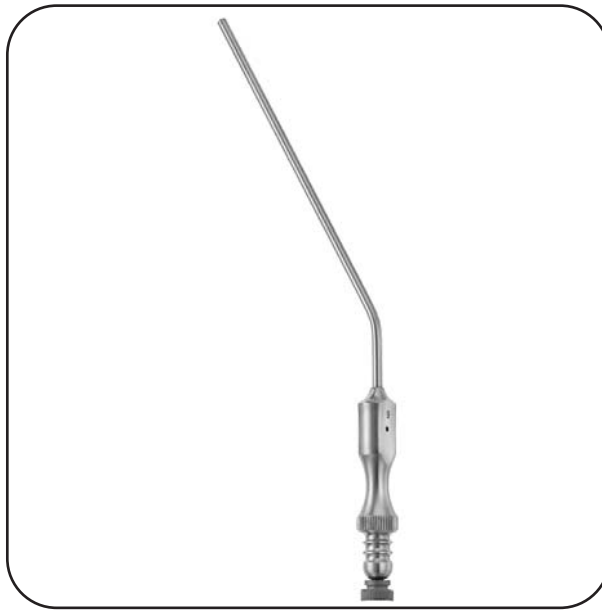

Saugrohre  
Suction Tubes  
Tubes d'aspiration  
Tubos de aspiración  
Tubi d'aspirazione



1/2

COOLEY  
**04.141.35**  
35 cm/14"  
Ø 8 mm



1/2

COOLEY  
**04.143.31**  
31 cm/12½"  
Ø 9 mm



1/2

COOLEY  
**04.145.30**  
30 cm/12"  
Ø 8 mm



1/2

COOLEY  
**04.147.33**  
33 cm/13¼"  
Ø 8 mm



**04.150.98**

Saugspitze  
 Suction Tip  
 Pointe de succion  
 Cabezal para aspiración  
 Punta per aspirazione



komplett mit Saugspitze und Schlaucholive

complete with suction tip and connector

complet avec pointe de succion et raccord

completo con punta de succión y conector

completi con punte d'aspirazione e raccordo

1/2

**04.150.99**  
 Schlaucholive  
 Olive  
 Olive  
 Oliva  
 Oliva

**YANKAUER**  
**04.150.27**  
 27 cm/10 1/4"



mit Absperrventil und abschraubbarem Rohr

with stopcock and tube to be screwed off

avec robinet et canule extérieure démontable

con interruptor y tubo desenroscable

con interruttore e tubo svitabile

1/2

**WALTON YANKAUER**  
**04.152.33**  
 ø 10 mm (30 Charr.)  
 32 cm/12 1/2"

Saug- und Spülkanüle  
Suction and Irrigation Cannula  
Canules d'aspiration et d'irrigation  
Cánulas para aspiración e irrigación  
Cannule per aspirazione e irrigazione

Saugkanülen mit Unterbrecher und Mandrin  
Suction Cannulae with finger cut-off and stylet  
Canules d'aspiration avec interrupteur à doigt  
Cánulas para aspiración con interruptor y estilete  
Cannule per aspirazione con interruttore e stiletto

Saugspitze ø 5 mm  
Suction Tip ø 5 mm  
Pointe de succion ø 5 mm  
Cabezal para aspiración ø 5 mm  
Punta per aspirazione ø 5 mm



1/2

Schlaucholive ø 9 mm  
Olive ø 9 mm  
Olive ø 9 mm  
Oliva ø 9 mm  
Oliva ø 9 mm

DE BAKEY

16 cm/6 1/4" **04.154.16**  
26 cm/10 1/4" **04.154.26**



1/2

DE BAKEY

**04.154.27**  
28 cm/11"



1/2

FINSTERER

**04.158.00**  
32 cm/12 1/2"



SCHMID  
15 cm/6"



**22.220.03**  
Ø 3 mm



**22.220.04**  
Ø 4 mm



**22.220.05**  
Ø 5 mm



**22.220.06**  
Ø 6 mm

Gefäßspülkanülen  
versilbert, biegsam, mit LUER-Lock Ansatz

Vascular irrigation cannulae  
silver plated, malleable, LUER-LOCK connection

Aiguilles vasculaires pour irrigation  
argentées, malléables, avec cône LUER-LOCK

Canulas vasculares para irrigación  
plateadas, maleables, con conexión LUER-LOCK

Aghi vascolari per irrigazione  
argentées, malleabili, attacco LUER-LOCK



½

POPPEL  
13 cm/5"

F.G. Charr.	ø mm	
6	2,0	<b>40.275.06</b>
8	2,7	<b>40.275.08</b>
10	3,3	<b>40.275.10</b>
12	4,0	<b>40.275.12</b>



½

ADSON  
**40.290.21**  
ø 4 mm (12 Charr.)  
21 cm/8¼"

Saugkanülen mit Unterbrecher und Mandrin  
 Suction Cannulae with finger cut-off and stylet  
 Canules d'aspiration avec interrupteur à doigt  
 Cánulas para aspiración con interruptor y estilete  
 Cannule per aspirazione con interruttore e stiletto



1/2

FRAZIER  
 19 cm/7 1/2"

F.G. Charr.	ø mm	30°	75°
6	2,0	40.295.06	40.297.06
7	2,3	40.295.07	40.297.07
8	2,7	40.295.08	40.297.08
9	3,0	40.295.09	40.297.09
10	3,3	40.295.10	40.297.10
11	3,7	40.295.11	40.297.11
12	4,0	40.295.12	40.297.12
15	5,0	40.295.15	40.297.15





Skalpelle, Messer, Aortastanzen  
Scalpels, Knifes, Aortic Punches  
Bistouris, Couteaux, Rongeurs pour aorte  
Bisturías, Cuchillos, Perforadores aórticos  
Bistrui, Coltelli, Pinze taglianti per aorta

Skalpelli, passend für  
 auswechselbare Skalpellklingen  
 Fig. 10, 11, 12, 13, 15

Scalpel Handles for scalpel  
 blades fig. 10, 11, 12, 13, 15

Manches pour bistouris, allant  
 avec les lames de bistouris  
 interchangeables  
 fig. 10, 11, 12, 13, 15

Mangos de bisturi para  
 hojas intercambiables  
 fig. 10, 11, 12, 13, 15

Manici per bisturi, per fissare  
 le lame intercambiabili  
 fig. 10, 11, 12, 13, 15

lang  
 long  
 long  
 largo  
 lungo

**Fig.**  
**3**

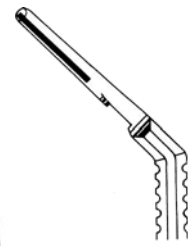

abgewinkelt, lang  
 angled, long  
 coudé, long  
 angulado, largo  
 angolare, lungo



**06.103.00**  
 Fig. 3  
 12 cm/4¾"



**06.103.02**  
 Fig. 3 L  
 21,5 cm/8½"



**06.103.06**  
 Fig. 3 L  
 21 cm/8¼"

Skalpelli, passend für  
 auswechselbare Skalpellklingen  
 Fig. 10, 11, 12, 13, 15

Scalpel Handles for scalpel  
 blades fig. 10, 11, 12, 13, 15

Manches pour bistouris, allant  
 avec les lames de bistouris  
 interchangeables  
 fig. 10, 11, 12, 13, 15

Mangos de bisturi para  
 hojas intercambiables  
 fig. 10, 11, 12, 13, 15

Manici per bisturi, per fissare  
 le lame intercambiabili  
 fig. 10, 11, 12, 13, 15

**Fig.  
 3**

rund  
 round  
 rond  
 redondo  
 rotondo



**06.103.03**  
 Fig. 3  
 14,5 cm/5<sup>3</sup>/<sub>4</sub>"

rund, abgewinkelt  
 round, angled  
 rond, coudé  
 redondo, angulado  
 rotondo, angolare



**06.103.33**  
 Fig. 3  
 14 cm/5<sup>1</sup>/<sub>2</sub>"

lang  
 long  
 long  
 largo  
 lungo



**06.107.00**  
 Fig. 7  
 16 cm/6<sup>1</sup>/<sub>4</sub>"

kurz  
 short  
 corto  
 court  
 corto



**06.107.01**  
 Fig. 7 K  
 12,5 cm/5"

Skalpеллgriffe  
 Scalpel Handles  
 Manches de bistouris  
 Mangos de bisturías  
 Manici per bisturi

**dimed**<sup>®</sup>

SURGICAL INSTRUMENTS

Skalpеллgriffe, passend für  
 auswechselbare Skalpеллklingen  
 Fig. 18, 19, 20, 21, 22, 23, 24, 25, 36

Scalpel Handles for scalpel  
 blades fig. 18, 19, 20, 21, 22, 23, 24, 25, 36

Manches pour bistouris, allant  
 avec les lames de bistouris  
 interchangeables  
 fig. 18, 19, 20, 21, 22, 23, 24, 25, 36

Mangos de bisturí para  
 hojas intercambiables  
 fig. 18, 19, 20, 21, 22, 23, 24, 25, 36

Manici per bisturi, per fissare  
 le lame intercambiabili  
 fig. 18, 19, 20, 21, 22, 23, 24, 25, 36

lang  
 long  
 long  
 long  
 largo  
 lungo

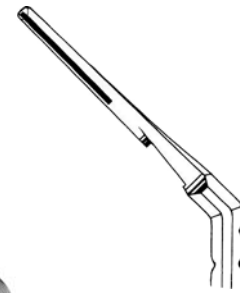

**Fig.**  
**4**

abgewinkelt, lang  
 angled, long  
 coudé, long  
 angulado, largo  
 angolaro, lungo



**06.104.00**  
 Fig. 4  
 13,5 cm/5¼"



**06.104.02**  
 Fig. 4 L  
 21 cm/8¼"



**06.104.06**  
 Fig. 4 L  
 21 cm/8¼"



**Fig.  
3**



**06.110.00**  
Fig. 10



**06.111.00**  
Fig. 11



**06.112.00**  
Fig. 12

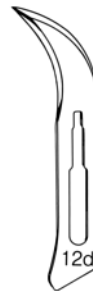

**06.112.02**  
Fig. 12 d



**06.115.00**  
Fig. 15



**06.115.01**  
Fig. 15 c

**Fig.  
4**



**06.118.00**  
Fig. 18



**06.119.00**  
Fig. 19



**06.120.00**  
Fig. 20



**06.121.00**  
Fig. 21



**06.122.00**  
Fig. 22



**06.123.00**  
Fig. 23



**06.124.00**  
Fig. 24



**06.125.00**  
Fig. 25

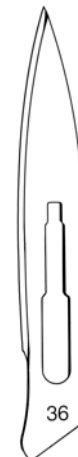

**06.136.00**  
Fig. 36

Skalpellklingen, steril  
Scalpel Blades, sterile  
Lames des bistouris, stériles  
Hojas de bisturíes estériles  
Lame da bisturi, sterili

**dimed**<sup>®</sup>

SURGICAL INSTRUMENTS



In Packungen à 100  
in packages of 100 ea  
en boîtes de 100 pieces  
en cajas de 100 c/u  
in scatole di 100 pezzi

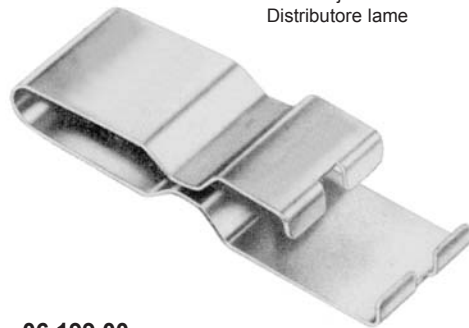

Skalpellklingen-Entferner  
Scalpel Blade Remover  
Enlève-lame  
Quita hojas  
Distributore lame

06.199.00

Skalpelli, Mikro-Skalpellklingen  
 Scalpel Handles, Micro Scalpel Blades  
 Manches pour bistouris, Micro lame de bistouris  
 Mangos de bisturí, Micro hojas de bisturí  
 Manici per bisturi, Micro lame per bisturi

**dimed**<sup>®</sup>

SURGICAL INSTRUMENTS

In Packungen à 10 Stück, steril  
 in packages of 10 ea, sterile  
 en boîtes de 10 pièces, stériles  
 en cajas de 10 c/u, estériles  
 in scatole di 10 pezzi, sterili



**40.859.01**  
Fig. 61



**40.859.02**  
Fig. 62



**40.859.10**  
Fig. 62 s



**40.859.04**  
Fig. 64

für Mikro-Skalpellklingen  
 for micro scalpel blades  
 pour micro-lame de bistouris  
 para micro hojas  
 per micro lame



**40.859.05**  
Fig. 65



**40.859.07**  
Fig. 67



**40.859.09**  
Fig. 69



**06.302.13**  
13,5 cm/5¼"

Einmalskalpelle, steril  
Disposable Scalpels, sterile  
Bistouris usage unique, stériles  
Bisturíes uso único, estériles  
Bisturi monouso, sterili

**dimed**®

SURGICAL INSTRUMENTS

In Packungen à 10 Stück  
in packages of 10 ea  
en boîtes de 10 pieces  
en cajas de 10 c/u  
in scatole di 10 pezzi



**06.210.00**  
Fig. 10



**06.211.00**  
Fig. 11



**06.212.00**  
Fig. 12



**06.212.02**  
Fig. 12 d



**06.213.00**  
Fig. 13



**06.215.00**  
Fig. 15



**06.215.01**  
Fig. 15 c

Einmalskalpelle, steril  
Disposable Scalpels, sterile  
Bistouris usage unique, stériles  
Bisturías uso único, estériles  
Bisturi monouso, sterili

**dimeda**<sup>®</sup>

SURGICAL INSTRUMENTS

In Packungen à 10 Stück  
in packages of 10 ea  
en boîtes de 10 pièces  
en cajas de 10 c/u  
in scatole di 10 pezzi



**06.218.00**  
Fig. 18



**06.219.00**  
Fig. 19



**06.220.00**  
Fig. 20



**06.221.00**  
Fig. 21



**06.222.00**  
Fig. 22



**06.223.00**  
Fig. 23



**06.224.00**  
Fig. 24



KARP



**56.380.04**  
Ø 4 mm  
16 cm/6¼"



**56.380.05**  
Ø 5 mm  
16 cm/6¼"





Scheren  
Scissors  
Ciseaux  
Tijeras  
Forbici

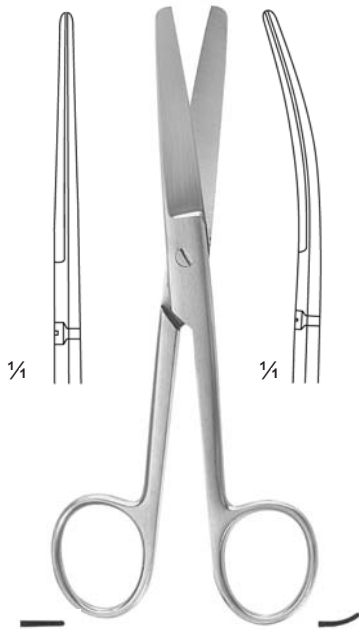

10,5 cm/4 <sup>1</sup> / <sub>4</sub> "	<b>08.102.10</b>	<b>08.103.10</b>
11,5 cm/4 <sup>1</sup> / <sub>2</sub> "	<b>08.102.11</b>	<b>08.103.11</b>
13 cm/5"	<b>08.102.13</b>	<b>08.103.13</b>
14,5 cm/5 <sup>3</sup> / <sub>4</sub> "	<b>08.102.14</b>	<b>08.103.14</b>
15,5 cm/6 <sup>1</sup> / <sub>4</sub> "	<b>08.102.15</b>	<b>08.103.15</b>
16,5 cm/6 <sup>1</sup> / <sub>2</sub> "	<b>08.102.16</b>	<b>08.103.16</b>
18,5 cm/7 <sup>1</sup> / <sub>4</sub> "	<b>08.102.18</b>	<b>08.103.18</b>
20 cm/8"	<b>08.102.20</b>	<b>08.103.20</b>



TC-Schneiden  
 TC Cutting Edges  
 Tranchant TC  
 Filos de corte TC  
 Taglio TC

14,5 cm/5 <sup>3</sup> / <sub>4</sub> "	<b>08.104.14</b>	<b>08.105.14</b>
16,5 cm/6 <sup>1</sup> / <sub>2</sub> "	<b>08.104.16</b>	<b>08.105.16</b>
18,5 cm/7 <sup>1</sup> / <sub>4</sub> "	<b>08.104.18</b>	<b>08.105.18</b>

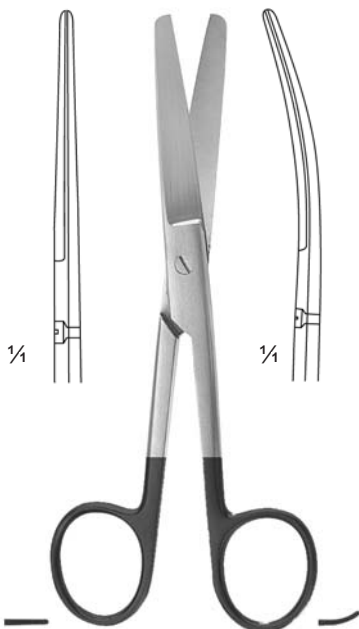

**SUPERCUT**

10,5 cm/4 <sup>1</sup> / <sub>4</sub> "	<b>07.102.10</b>	<b>07.103.10</b>
11,5 cm/4 <sup>1</sup> / <sub>2</sub> "	<b>07.102.11</b>	<b>07.103.11</b>
13 cm/5"	<b>07.102.13</b>	<b>07.103.13</b>
14,5 cm/5 <sup>3</sup> / <sub>4</sub> "	<b>07.102.14</b>	<b>07.103.14</b>
15,5 cm/6 <sup>1</sup> / <sub>4</sub> "	<b>07.102.15</b>	<b>07.103.15</b>
16,5 cm/6 <sup>1</sup> / <sub>2</sub> "	<b>07.102.16</b>	<b>07.103.16</b>
18,5 cm/7 <sup>1</sup> / <sub>4</sub> "	<b>07.102.18</b>	<b>07.103.18</b>
20 cm/8"	<b>07.102.20</b>	<b>07.103.20</b>



TC-Schneiden  
 TC Cutting Edges  
 Tranchant TC  
 Filos de corte TC  
 Taglio TC

14,5 cm/5 <sup>3</sup> / <sub>4</sub> "	<b>07.104.14</b>	<b>07.105.14</b>
16,5 cm/6 <sup>1</sup> / <sub>2</sub> "	<b>07.104.16</b>	<b>07.105.16</b>

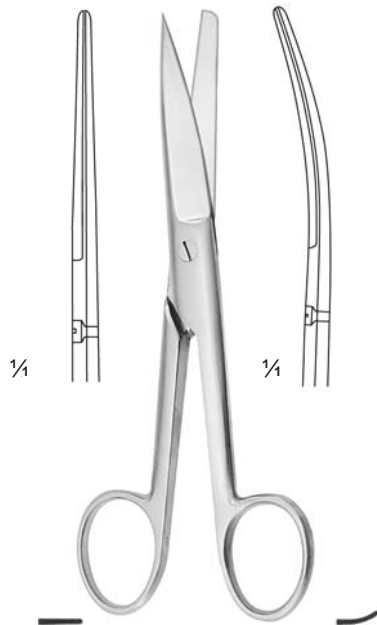

10,5 cm/4 $\frac{1}{4}$ "	<b>08.110.10</b>	<b>08.111.10</b>
11,5 cm/4 $\frac{1}{2}$ "	<b>08.110.11</b>	<b>08.111.11</b>
13 cm/5"	<b>08.110.13</b>	<b>08.111.13</b>
14,5 cm/5 $\frac{3}{4}$ "	<b>08.110.14</b>	<b>08.111.14</b>
15,5 cm/6 $\frac{1}{4}$ "	<b>08.110.15</b>	<b>08.111.15</b>
16,5 cm/6 $\frac{1}{2}$ "	<b>08.110.16</b>	<b>08.111.16</b>
18,5 cm/7 $\frac{1}{4}$ "	<b>08.110.18</b>	<b>08.111.18</b>
20 cm/8"	<b>08.110.20</b>	<b>08.111.20</b>

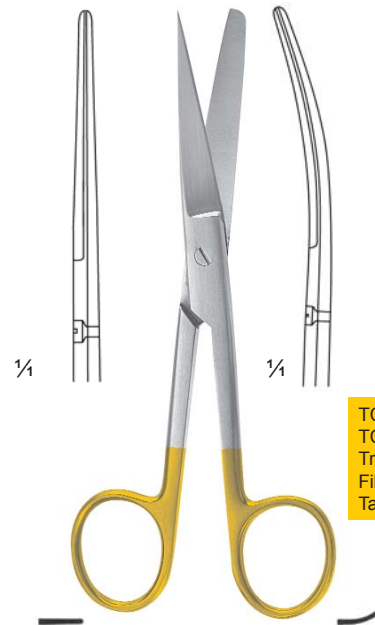

TC-Schneiden  
 TC Cutting Edges  
 Tranchant TC  
 Filos de corte TC  
 Taglio TC

14,5 cm/5 $\frac{3}{4}$ "	<b>08.114.14</b>	<b>08.115.14</b>
16,5 cm/6 $\frac{1}{2}$ "	<b>08.114.16</b>	<b>08.115.16</b>
18,5 cm/7 $\frac{1}{4}$ "	<b>08.114.18</b>	<b>08.115.18</b>

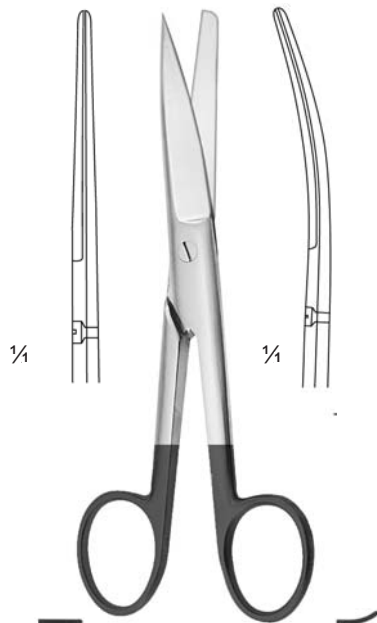

**SUPERCUT**

11,5 cm/4 $\frac{1}{2}$ "	<b>07.110.11</b>	<b>07.111.11</b>
13 cm/5"	<b>07.110.13</b>	<b>07.111.13</b>
14,5 cm/5 $\frac{3}{4}$ "	<b>07.110.14</b>	<b>07.111.14</b>
15,5 cm/6 $\frac{1}{4}$ "	<b>07.110.15</b>	<b>07.111.15</b>
16,5 cm/6 $\frac{1}{2}$ "	<b>07.110.16</b>	<b>07.111.16</b>
18,5 cm/7 $\frac{1}{4}$ "	<b>07.110.18</b>	<b>07.111.18</b>
20 cm/8"	<b>07.110.20</b>	<b>07.111.20</b>



TC-Schneiden  
 TC Cutting Edges  
 Tranchant TC  
 Filos de corte TC  
 Taglio TC

14,5 cm/5 $\frac{3}{4}$ "	<b>07.114.14</b>	<b>07.115.14</b>
16,5 cm/6 $\frac{1}{2}$ "	<b>07.114.16</b>	<b>07.115.16</b>

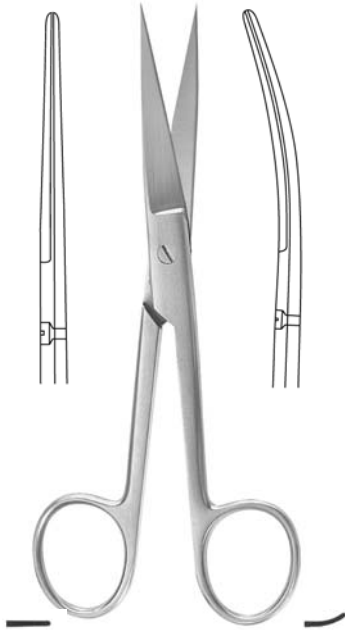

10,5 cm/4¼"	<b>08.120.10</b>	<b>08.121.10</b>
11,5 cm/4½"	<b>08.120.11</b>	<b>08.121.11</b>
13 cm/5"	<b>08.120.13</b>	<b>08.121.13</b>
14,5 cm/5¾"	<b>08.120.14</b>	<b>08.121.14</b>
15,5 cm/6¼"	<b>08.120.15</b>	<b>08.121.15</b>
16,5 cm/6½"	<b>08.120.16</b>	<b>08.121.16</b>
18,5 cm/7¼"	<b>08.120.18</b>	<b>08.121.18</b>
20 cm/8"	<b>08.120.20</b>	<b>08.121.20</b>

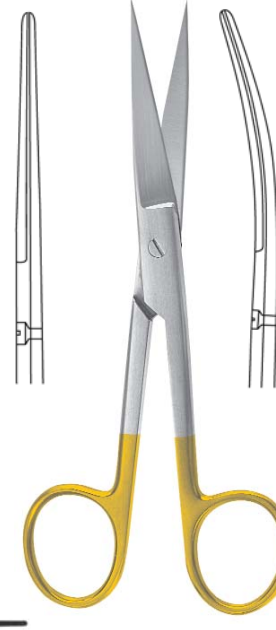

TC-Schneiden  
 TC Cutting Edges  
 Tranchant TC  
 Filos de corte TC  
 Taglio TC

14,5 cm/5¾"	<b>08.124.14</b>	<b>08.125.14</b>
16,5 cm/6½"	<b>08.124.16</b>	<b>08.125.16</b>
18,5 cm/7¼"	<b>08.124.18</b>	<b>08.125.18</b>



**SUPERCUT**

10,5 cm/4¼"	<b>07.120.10</b>	<b>07.121.10</b>
11,5 cm/4½"	<b>07.120.11</b>	<b>07.121.11</b>
13 cm/5"	<b>07.120.13</b>	<b>07.121.13</b>
14,5 cm/5¾"	<b>07.120.14</b>	<b>07.121.14</b>
15,5 cm/6¼"	<b>07.120.15</b>	<b>07.121.15</b>
16,5 cm/6½"	<b>07.120.16</b>	<b>07.121.16</b>
18,5 cm/7¼"	<b>07.120.18</b>	<b>07.121.18</b>
20 cm/8"	<b>07.120.20</b>	<b>07.121.20</b>

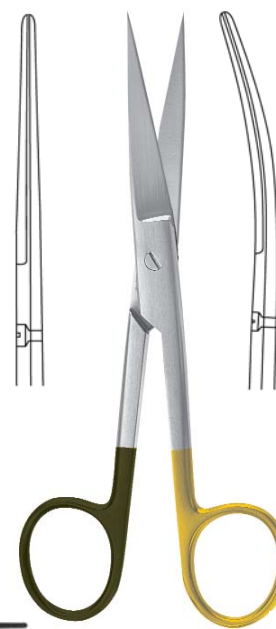

TC-Schneiden  
 TC Cutting Edges  
 Tranchant TC  
 Filos de corte TC  
 Taglio TC

14,5 cm/5¾"	<b>07.124.14</b>	<b>07.125.14</b>
16,5 cm/6½"	<b>07.124.16</b>	<b>07.125.16</b>

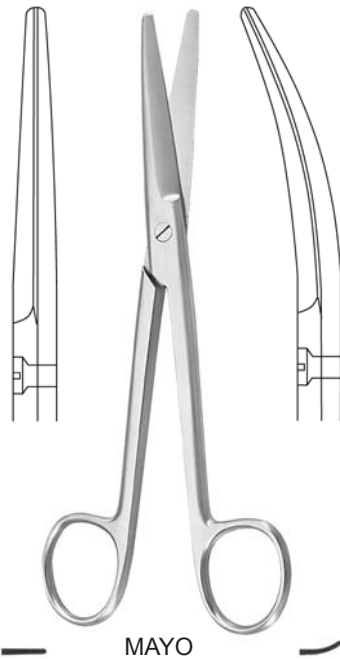

MAYO

14,5 cm/5 <sup>3</sup> / <sub>4</sub> "	<b>08.160.14</b>	<b>08.161.14</b>
17 cm/6 <sup>3</sup> / <sub>4</sub> "	<b>08.160.17</b>	<b>08.161.17</b>
19 cm/7 <sup>1</sup> / <sub>2</sub> "	<b>08.160.19</b>	<b>08.161.19</b>
23 cm/9"	<b>08.160.23</b>	<b>08.161.23</b>
28 cm/11"	<b>08.160.28</b>	<b>08.161.28</b>

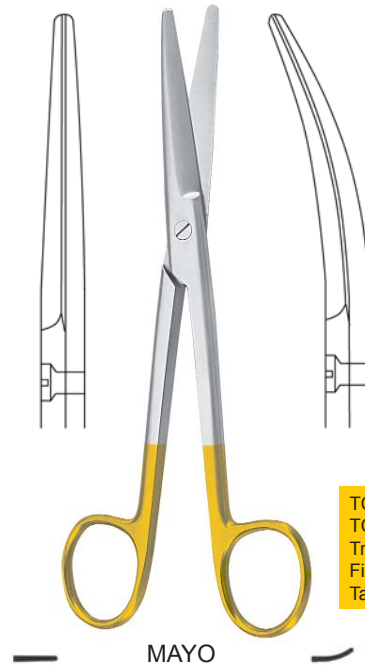

MAYO

TC-Schneiden  
 TC Cutting Edges  
 Tranchant TC  
 Filos de corte TC  
 Taglio TC

14,5 cm/5 <sup>3</sup> / <sub>4</sub> "	<b>08.164.14</b>	<b>08.165.14</b>
17 cm/6 <sup>3</sup> / <sub>4</sub> "	<b>08.164.17</b>	<b>08.165.17</b>
23 cm/9"	<b>08.164.23</b>	<b>08.165.23</b>

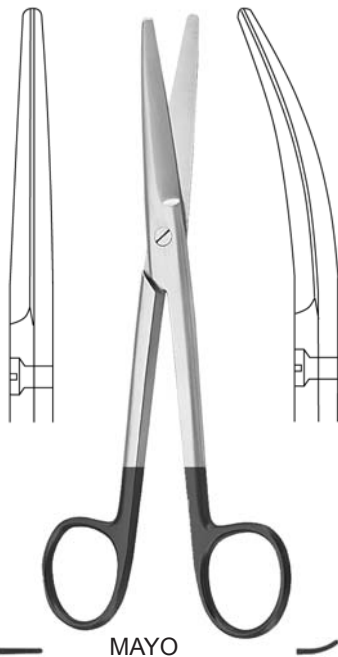

MAYO

14,5 cm/5 <sup>3</sup> / <sub>4</sub> "	<b>07.160.14</b>	<b>07.161.14</b>
17 cm/6 <sup>3</sup> / <sub>4</sub> "	<b>07.160.17</b>	<b>07.161.17</b>
23 cm/9"	<b>07.160.23</b>	<b>07.161.23</b>

**SUPERCUT**

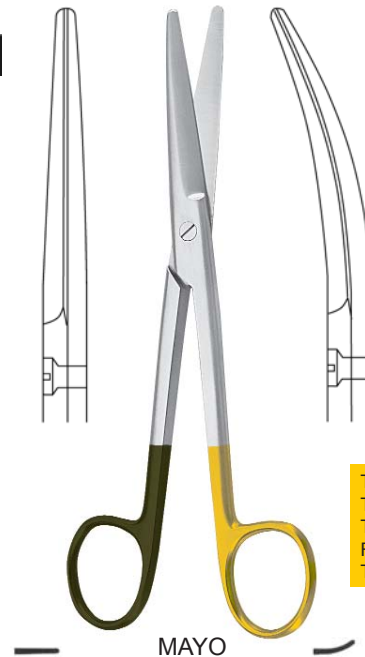

MAYO

TC-Schneiden  
 TC Cutting Edges  
 Tranchant TC  
 Filos de corte TC  
 Taglio TC

14,5 cm/5 <sup>3</sup> / <sub>4</sub> "	<b>07.164.14</b>	<b>07.165.14</b>
17 cm/6 <sup>3</sup> / <sub>4</sub> "	<b>07.164.17</b>	<b>07.165.17</b>
23 cm/9"	<b>07.164.23</b>	<b>07.165.23</b>

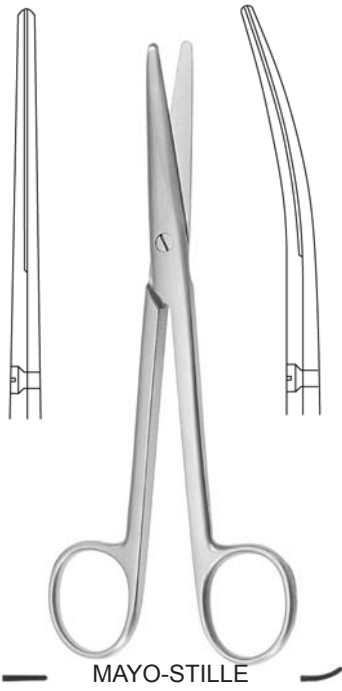

15 cm/6"	<b>08.170.15</b>	<b>08.171.15</b>
17 cm/6¾"	<b>08.170.17</b>	<b>08.171.17</b>

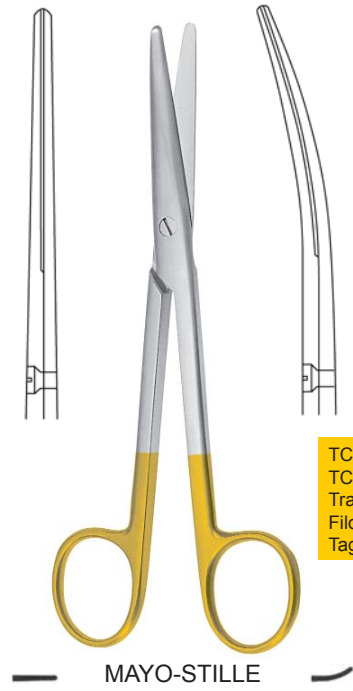

TC-Schneiden  
 TC Cutting Edges  
 Tranchant TC  
 Filos de corte TC  
 Taglio TC

15 cm/6"	<b>08.174.15</b>	<b>08.175.15</b>
17 cm/6¾"	<b>08.174.17</b>	<b>08.175.17</b>

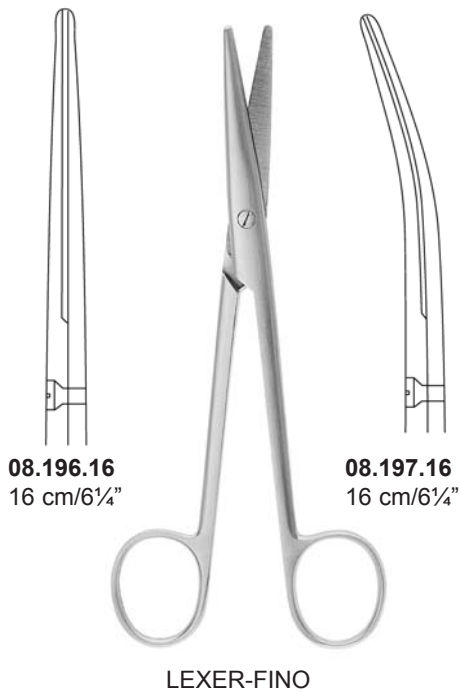



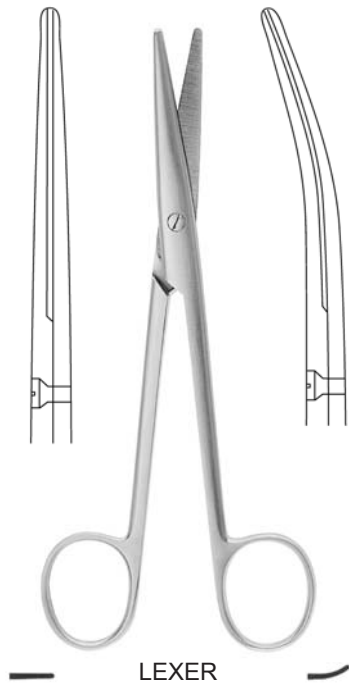

16 cm/6¼"	<b>08.190.16</b>	<b>08.191.16</b>
21 cm/8¼"	<b>08.190.21</b>	<b>08.191.21</b>



16 cm/6¼"	<b>08.194.16</b>	<b>08.195.16</b>
21 cm/8¼"	<b>08.194.21</b>	<b>08.195.21</b>

TC-Schneiden  
 TC Cutting Edges  
 Tranchant TC  
 Filos de corte TC  
 Taglio TC

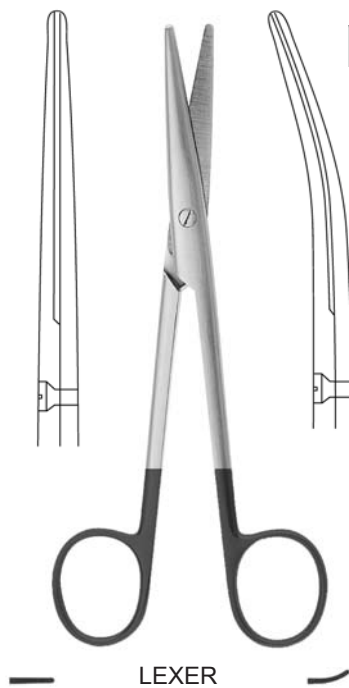

16 cm/6¼"	<b>07.190.16</b>	<b>07.191.16</b>
21 cm/8¼"	<b>07.190.21</b>	<b>07.191.21</b>

**SUPERCUT**



16 cm/6¼"	<b>07.194.16</b>	<b>07.195.16</b>
21 cm/8¼"	<b>07.194.21</b>	<b>07.195.21</b>

TC-Schneiden  
 TC Cutting Edges  
 Tranchant TC  
 Filos de corte TC  
 Taglio TC



METZENBAUM

15 cm/6"	<b>08.280.15</b>	<b>08.281.15</b>
18 cm/7"	<b>08.280.18</b>	<b>08.281.18</b>
20 cm/8"	<b>08.280.20</b>	<b>08.281.20</b>
23 cm/9"	<b>08.280.23</b>	<b>08.281.23</b>
25 cm/10"	<b>08.280.25</b>	<b>08.281.25</b>
28 cm/11"	<b>08.280.28</b>	<b>08.281.28</b>
30 cm/12"	<b>08.280.30</b>	<b>08.281.30</b>



METZENBAUM

TC-Schneiden  
 TC Cutting Edges  
 Tranchant TC  
 Filos de corte TC  
 Taglio TC

15 cm/6"	<b>08.284.15</b>	<b>08.285.15</b>
18 cm/7"	<b>08.284.18</b>	<b>08.285.18</b>
20 cm/8"	<b>08.284.20</b>	<b>08.285.20</b>
23 cm/9"	<b>08.284.23</b>	<b>08.285.23</b>
25 cm/10"	<b>08.284.25</b>	<b>08.285.25</b>
28 cm/11"	<b>08.284.28</b>	<b>08.285.28</b>
30 cm/12"	<b>08.284.30</b>	<b>08.285.30</b>

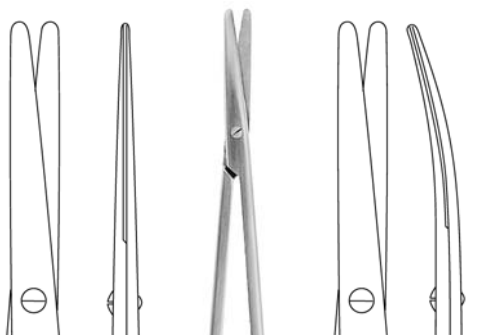

METZENBAUM

**SUPERCUT**



METZENBAUM

TC-Schneiden  
 TC Cutting Edges  
 Tranchant TC  
 Filos de corte TC  
 Taglio TC

11,5 cm/4½"	<b>07.280.11</b>	<b>07.281.11</b>
15 cm/6"	<b>07.280.15</b>	<b>07.281.15</b>
18 cm/7"	<b>07.280.18</b>	<b>07.281.18</b>
20 cm/8"	<b>07.280.20</b>	<b>07.281.20</b>
23 cm/9"	<b>07.280.23</b>	<b>07.281.23</b>
25 cm/10"	<b>07.280.25</b>	<b>07.281.25</b>
28 cm/11"	<b>07.280.28</b>	<b>07.281.28</b>
30 cm/12"	<b>07.280.30</b>	<b>07.281.30</b>

11,5 cm/4½"	<b>07.284.11</b>	<b>07.285.11</b>
15 cm/6"	<b>07.284.15</b>	<b>07.285.15</b>
18 cm/7"	<b>07.284.18</b>	<b>07.285.18</b>
20 cm/8"	<b>07.284.20</b>	<b>07.285.20</b>
23 cm/9"	<b>07.284.23</b>	<b>07.285.23</b>
25 cm/10"	<b>07.284.25</b>	<b>07.285.25</b>
28 cm/11"	<b>07.284.28</b>	<b>07.285.28</b>
30 cm/12"	<b>07.284.30</b>	<b>07.285.30</b>

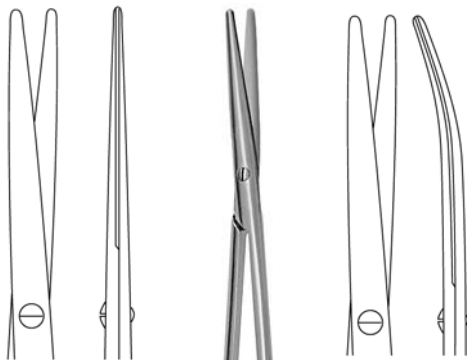

METZENBAUM FINO

15 cm/6"	<b>08.282.15</b>	<b>08.283.15</b>
18 cm/7"	<b>08.282.18</b>	<b>08.283.18</b>
20 cm/8"	<b>08.282.20</b>	<b>08.283.20</b>
23 cm/9"	<b>08.282.23</b>	<b>08.283.23</b>
25 cm/10"	<b>08.282.25</b>	<b>08.283.25</b>
28 cm/11"	<b>08.282.28</b>	<b>08.283.28</b>



METZENBAUM FINO

TC-Schneiden  
 TC Cutting Edges  
 Tranchant TC  
 Filos de corte TC  
 Taglio TC

15 cm/6"	<b>08.286.15</b>	<b>08.287.15</b>
18 cm/7"	<b>08.286.18</b>	<b>08.287.18</b>
20 cm/8"	<b>08.286.20</b>	<b>08.287.20</b>
23 cm/9"	<b>08.286.23</b>	<b>08.287.23</b>
25 cm/10"	<b>08.286.25</b>	<b>08.287.25</b>
28 cm/11"	<b>08.286.28</b>	<b>08.287.28</b>



**METZENBAUM FINO "S"**  
**08.291.18**  
 18 cm/7"



**METZENBAUM FINO "S"**  
**08.295.18**  
 18 cm/7"

TC-Schneiden  
 TC Cutting Edges  
 Tranchant TC  
 Filos de corte TC  
 Taglio TC



**METZENBAUM-NELSON**  
 18 cm/7"    **08.288.18**  
 20 cm/8"    **08.288.20**



**08.302.14**  
 14 cm/5½"



**08.303.14**  
 14 cm/5½"



**08.304.14**  
 14 cm/5½"



**08.305.14**  
 14 cm/5½"

Plastik  
 Plastic  
 Plastique  
 Plástica  
 Plastica

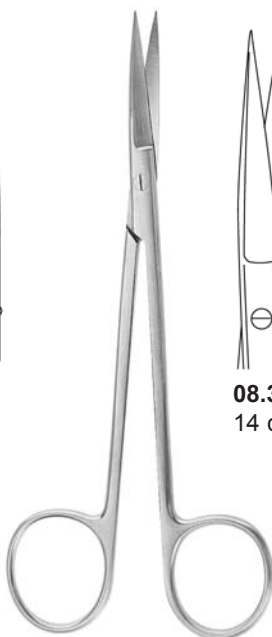

**SANVENERO**

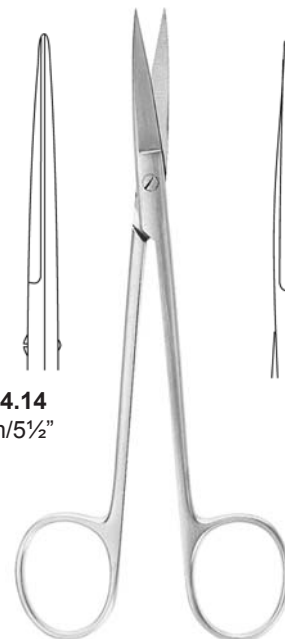

**JOSEPH**

Plastik  
 Plastic  
 Plastique  
 Plástica  
 Plastica

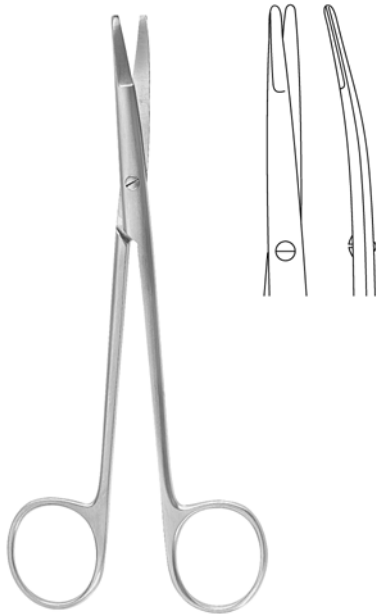

KILNER

12 cm/4¾" **08.310.12**  
 15 cm/6" **08.310.15**



TC-Schneiden  
 TC Cutting Edges  
 Tranchant TC  
 Filos de corte TC  
 Taglio TC

KILNER

12 cm/4¾" **08.314.12**  
 15 cm/6" **08.314.15**



REYNOLDS  
**08.320.15**  
 15 cm/6"



REYNOLDS  
 15 cm/6" **08.321.15**  
 18 cm/7" **08.321.18**



REYNOLDS  
**08.324.15**  
 15 cm/6"

TC-Schneiden  
 TC Cutting Edges  
 Tranchant TC  
 Filos de corte TC  
 Taglio TC



REYNOLDS  
**08.325.15**  
 15 cm/6"

TC-Schneiden  
 TC Cutting Edges  
 Tranchant TC  
 Filos de corte TC  
 Taglio TC

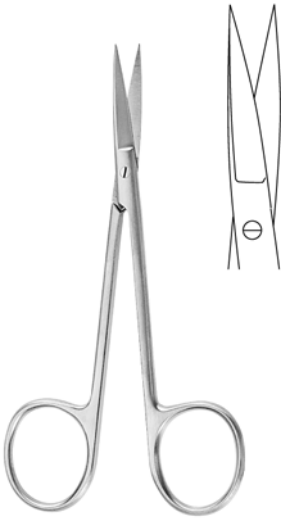

IRIS

9 cm/3½" **08.340.09**  
 10,5 cm/4¼" **08.340.10**  
 11,5 cm/4½" **08.340.11**  
 12,5 cm/5" **08.340.12**



IRIS

9 cm/3½" **08.341.09**  
 10,5 cm/4¼" **08.341.10**  
 11,5 cm/4½" **08.341.11**  
 12,5 cm/5" **08.341.12**



IRIS

**08.344.11**  
 11,5 cm/4½"



IRIS

**08.345.11**  
 11,5 cm/4½"



IRIS

**08.351.11**  
 11,5 cm/4½"



IRIS

**08.354.11**  
 11,5 cm/4½"



IRIS

**08.353.11**  
 11,5 cm/4½"



**08.470.11**

11,5 cm/4½"





POTTS-SMITH

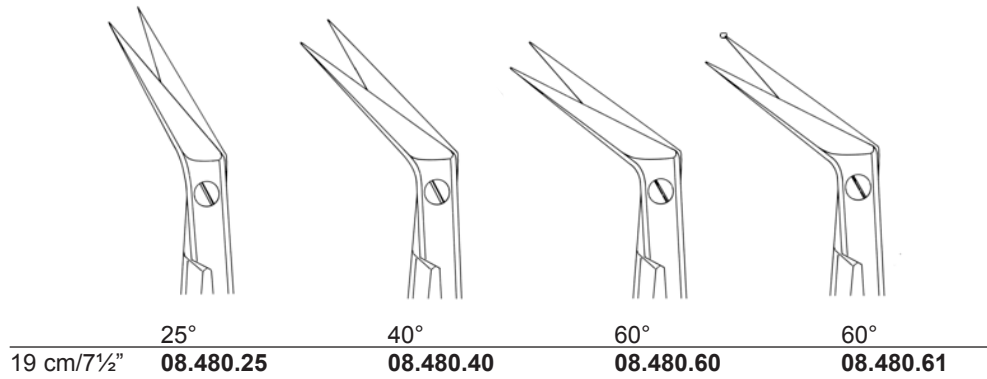

POTTS-SMITH

TC-Schneiden  
 TC Cutting Edges  
 Tranchant TC  
 Filos de corte TC  
 Taglio TC

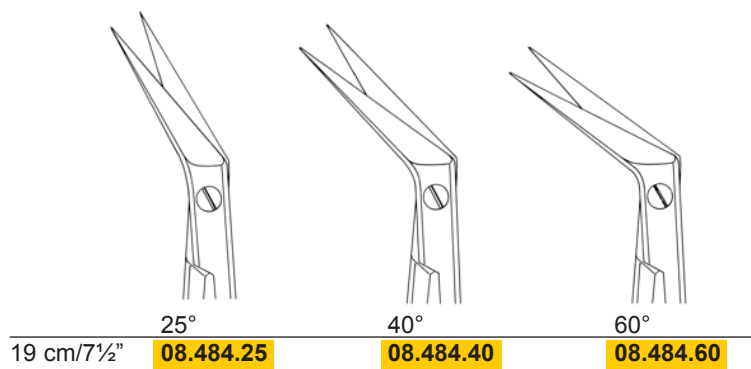

**SUPERCUT**



POTTS-SMITH

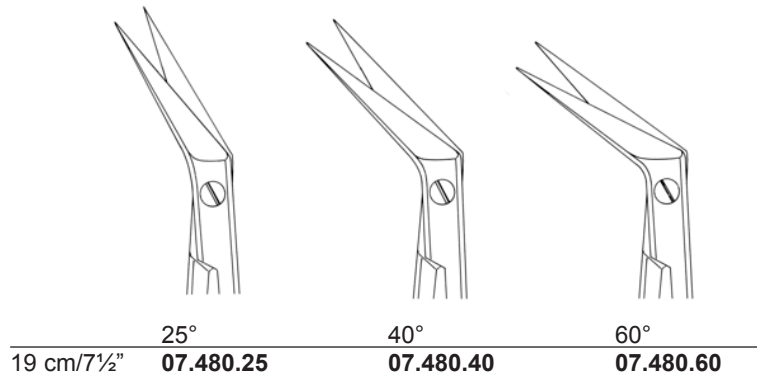

POTTS-SMITH

TC-Schneiden  
 TC Cutting Edges  
 Tranchant TC  
 Filos de corte TC  
 Taglio TC

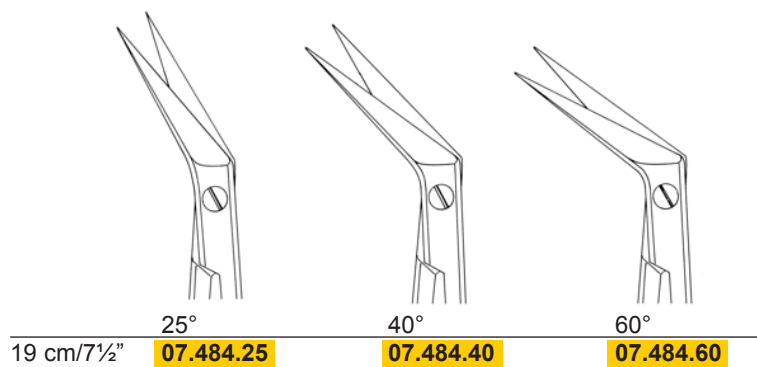

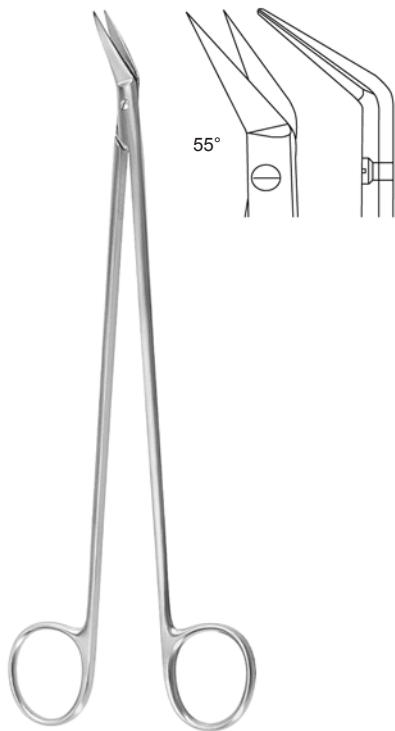

POTTS-SMITH  
**08.480.18**  
 18 cm/7"



DIETHRICH  
**08.486.25**  
 18 cm/7"

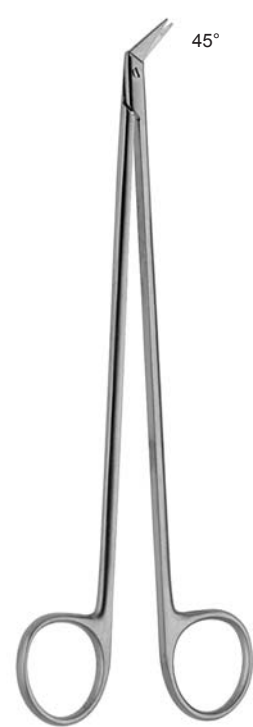

DIETHRICH  
**08.486.45**  
 18 cm/7"

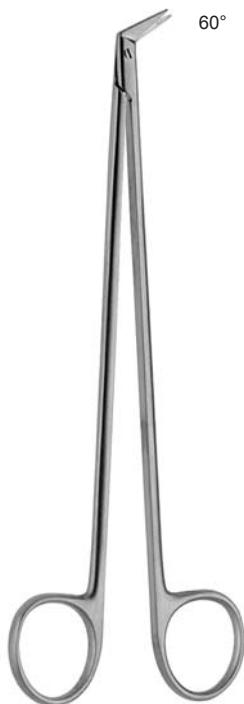

DIETHRICH  
**08.486.60**  
 18 cm/7"



DIETHRICH  
**08.486.90**  
 18 cm/7"



DIETHRICH  
**08.487.25**  
 18 cm/7"



DIETHRICH  
**08.488.25**  
 18 cm/7"



DE BAKEY



25°



45°

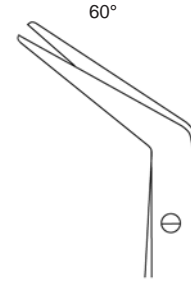

60°

	25°	45°	60°
16 cm/6¼"	<b>08.490.16</b>	<b>08.491.16</b>	<b>08.492.16</b>
23 cm/9"	<b>08.490.23</b>	<b>08.491.23</b>	<b>08.492.23</b>
28 cm/11"	<b>08.490.28</b>	<b>08.491.28</b>	<b>08.492.28</b>



DE BAKEY

23 cm/9"	<b>08.493.23</b>
28 cm/11"	<b>08.493.28</b>



45°

TC-Schneiden  
 TC Cutting Edges  
 Tranchant TC  
 Filos de corte TC  
 Taglio TC

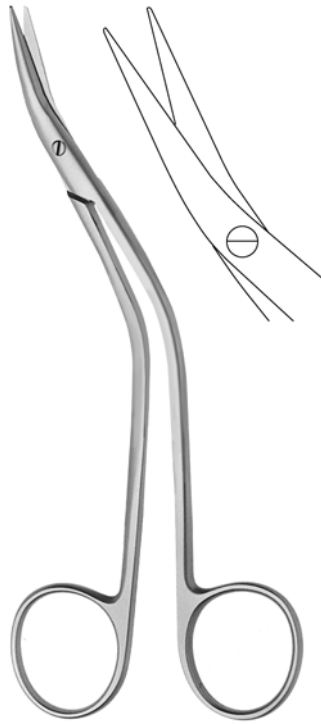

DE BAKEY  
**08.495.15**  
15,5 cm/6"



DE BAKEY  
**08.497.15**  
15,5 cm/6"



FAVALORO  
**08.500.14**  
15,5 cm/6"



**08.582.15**  
 15 cm/6"

Nerv-Präparierschere  
 Never dissecting scissors  
 Ciseaux a preparation de nerfs  
 Tijara para preparación del nervio  
 Forbici per preparazione di nervi



**08.583.15**  
 15 cm/6"

Sternum Scheren  
 Sternum scissors  
 Ciseaux a sternum  
 Tijeras de esternón  
 Forbici per sterno



**BRAUN-STADTLER**  
**08.560.20**  
 20 cm/8"



**TOENNIS-ADSON**  
**08.613.17**  
 17 cm/6¾"

TC-Schneiden  
 TC Cutting Edges  
 Tranchant TC  
 Filos de corte TC  
 Taglio TC

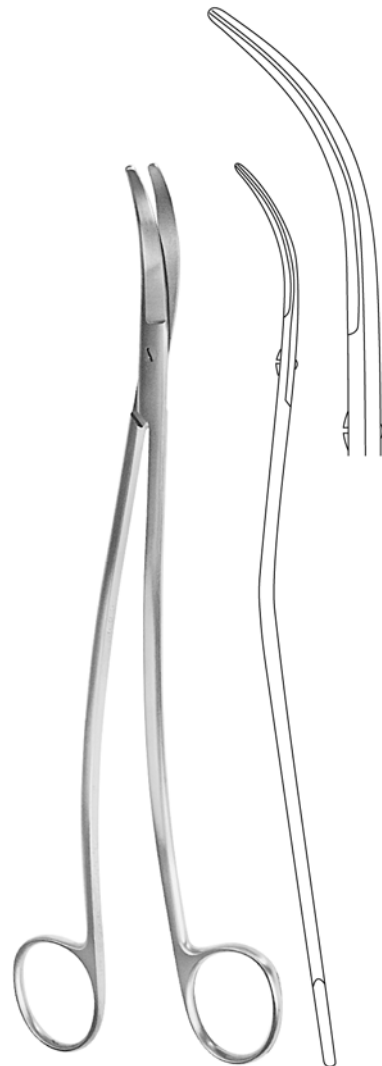

**SATINSKY**  
**08.651.24**  
 24,5 cm/9¼"



spitz  
 sharp  
 pointu  
 agudo  
 appuntato



½



25°  
**09.224.25**  
 18 cm/7"



45°  
**09.224.45**  
 18 cm/7"



60°  
**09.224.60**  
 18 cm/7"

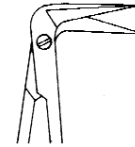

90°  
**09.224.90**  
 18 cm/7"

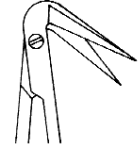

125°  
**09.225.00**  
 18 cm/7"



Schneide 10mm  
 Cutting edge 10mm  
 Tranchant 10mm  
 Filo cortante 10 mm  
 Filo di lama 10mm



15 cm/6"	<b>09.710.15</b>	<b>09.711.15</b>
18 cm/7"	<b>09.710.18</b>	<b>09.711.18</b>
21 cm/8¼"	<b>09.710.21</b>	<b>09.711.21</b>
23 cm/9"	<b>09.710.23</b>	<b>09.711.23</b>

Rundgriff  
 Round handle  
 Manche rind  
 Mango redondo  
 Manico rotondo



Schneide 10mm  
 Cutting edge 10mm  
 Tranchant 10mm  
 Filo cortante 10 mm  
 Filo di lama 10mm



15 cm/6"	<b>09.712.15</b>	<b>09.713.15</b>
18 cm/7"	<b>09.712.18</b>	<b>09.713.18</b>
21 cm/8¼"	<b>09.712.21</b>	<b>09.713.21</b>
23 cm/9"	<b>09.712.23</b>	<b>09.713.23</b>

Flachgriff  
 Flat handle  
 Manche plat  
 Mango plano  
 Manico piatto

*dimeda*<sup>®</sup>

SURGICAL INSTRUMENTS

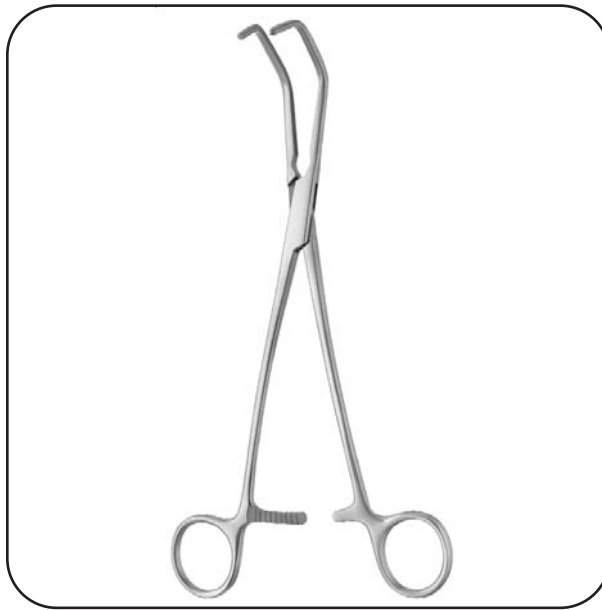

Pinzetten & Klemmen

Forceps

Pinces

Pinzas

Pinze

schmal  
narrow  
étroite  
estrecha  
stretta



Mit TC-Einsätzen  
TC Lined  
A mors TC  
Con bocas TC  
Con morso TC



Mit TC-Einsätzen  
TC Lined  
A mors TC  
Con bocas TC  
Con morso TC

POTTS-SMITH

11,5 cm/4½"	<b>10.102.11</b>	<b>10.110.11</b>
13 cm/5"	<b>10.102.13</b>	<b>10.110.13</b>
14,5 cm/5¾"	<b>10.102.14</b>	<b>10.110.14</b>
16 cm/6¼"	<b>10.102.16</b>	<b>10.110.16</b>
18 cm/7"	<b>10.102.18</b>	<b>10.110.18</b>
20 cm/8"	<b>10.102.20</b>	<b>10.110.20</b>
25 cm/10"	<b>10.102.25</b>	<b>10.110.25</b>
30 cm/12"	<b>10.102.30</b>	<b>10.110.30</b>

14 cm/5½"	<b>10.114.14</b>
16 cm/6¼"	<b>10.114.16</b>

18 cm/7"	<b>10.112.18</b>	<b>10.116.18</b>
21 cm/8¼"	<b>10.112.21</b>	<b>10.116.21</b>
25 cm/10"	<b>10.112.25</b>	<b>10.116.25</b>
30 cm/12"	<b>10.112.30</b>	

1:2

1:2



1:2



schmal  
narrow  
étroite  
estrecha  
stretta

1:2



mittel  
medium  
milieu  
medio  
mezzo



11,5 cm/4½"	<b>10.120.11</b>	<b>10.130.11</b>
13 cm/5"	<b>10.120.13</b>	<b>10.130.13</b>
14,5 cm/5¾"	<b>10.120.14</b>	<b>10.130.14</b>
16 cm/6¼"	<b>10.120.16</b>	<b>10.130.16</b>
18 cm/7"	<b>10.120.18</b>	<b>10.130.18</b>
20 cm/8"	<b>10.120.20</b>	<b>10.130.20</b>
25 cm/10"	<b>10.120.25</b>	<b>10.130.25</b>
30 cm/12"	<b>10.120.30</b>	<b>10.130.30</b>

13 cm/5"	<b>10.131.13</b>
14 cm/5½"	<b>10.131.14</b>

POTTS-SMITH

18 cm/7"	<b>10.126.18</b>
21 cm/8¼"	<b>10.126.21</b>
25 cm/10"	<b>10.126.25</b>



Mit TC-Einsätzen  
 TC Lined  
 A mors TC  
 Con bocas TC  
 Con morso TC

ADSON

12 cm/4 <sup>3</sup> / <sub>4</sub> "	<b>10.170.12</b>	<b>10.174.12</b>
15 cm/6"	<b>10.170.15</b>	<b>10.174.15</b>



ADSON micro

12 cm/4 <sup>3</sup> / <sub>4</sub> "	<b>10.176.12</b>
15 cm/6"	<b>10.176.15</b>



Mit TC-Einsätzen  
 TC Lined  
 A mors TC  
 Con bocas TC  
 Con morso TC

ADSON

12 cm/4 <sup>3</sup> / <sub>4</sub> "	<b>10.180.12</b>	<b>10.184.12</b>
15 cm/6"	<b>10.180.15</b>	<b>10.184.15</b>



ADSON micro

12 cm/4 <sup>3</sup> / <sub>4</sub> "	<b>10.186.12</b>
15 cm/6"	<b>10.186.15</b>



CUSHING  
**10.220.17**  
 17 cm/6¾"



CUSHING  
 17 cm/6¾"

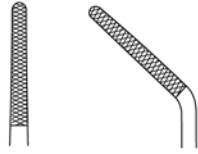

**10.224.17** **10.225.17**

Mit TC-Einsätzen  
 TC Lined  
 A mors TC  
 Con bocas TC  
 Con morso TC



CUSHING-TAYLOR  
**10.226.18**  
 18 cm/7"

Mit TC-Einsätzen  
 TC Lined  
 A mors TC  
 Con bocas TC  
 Con morso TC



1:2



CUSHING  
**10.230.17**  
 17 cm/6¾"



WAUGH  
 15 cm/5" **10.262.15**  
 20 cm/8" **10.262.20**



**SEMKEN**  
 12,5 cm/5" **10.260.12**  
 15,5 cm/6" **10.260.15**



**GILLIES**  
**10.272.15**  
 15,5 cm/6"



**GERALD**  
**10.302.18**  
 18 cm/7"



**GERALD**  
**10.304.17**  
 17,5 cm/7"

Mit TC-Einsätzen  
 TC Lined  
 A mors TC  
 Con bocas TC  
 Con morso TC



**SEMKEN**  
 12,5 cm/5" **10.270.12**  
 15,5 cm/6" **10.270.15**



**GILLIES**  
**10.272.16**  
 15,5 cm/6"

Mit TC-Einsätzen  
 TC Lined  
 A mors TC  
 Con bocas TC  
 Con morso TC



**GERALD**  
 18 cm/7" **10.310.18**  
 23 cm/9" **10.310.23**



**GERALD**  
**10.306.17**  
 17,5 cm/7"

Mit TC-Einsätzen  
 TC Lined  
 A mors TC  
 Con bocas TC  
 Con morso TC

Mit TC-Einsätzen  
 TC Lined  
 A mors TC  
 Con bocas TC  
 Con morso TC



Mit TC-Einsätzen  
 TC Lined  
 A mors TC  
 Con bocas TC  
 Con morso TC

McINDOE		SINGLY		NELSON		WANGENSTEEN	
15 cm/6"	<b>10.258.15</b>	18 cm/7"	<b>10.320.18</b>	15,5 cm/6"	<b>10.322.15</b>	15,5 cm/6"	<b>10.326.15</b>
	<b>10.257.15</b>	23 cm/9"	<b>10.320.23</b>	18 cm/7"	<b>10.322.18</b>	23 cm/9"	<b>10.326.23</b>
				23 cm/9"	<b>10.322.23</b>	25 cm/10"	<b>10.326.25</b>

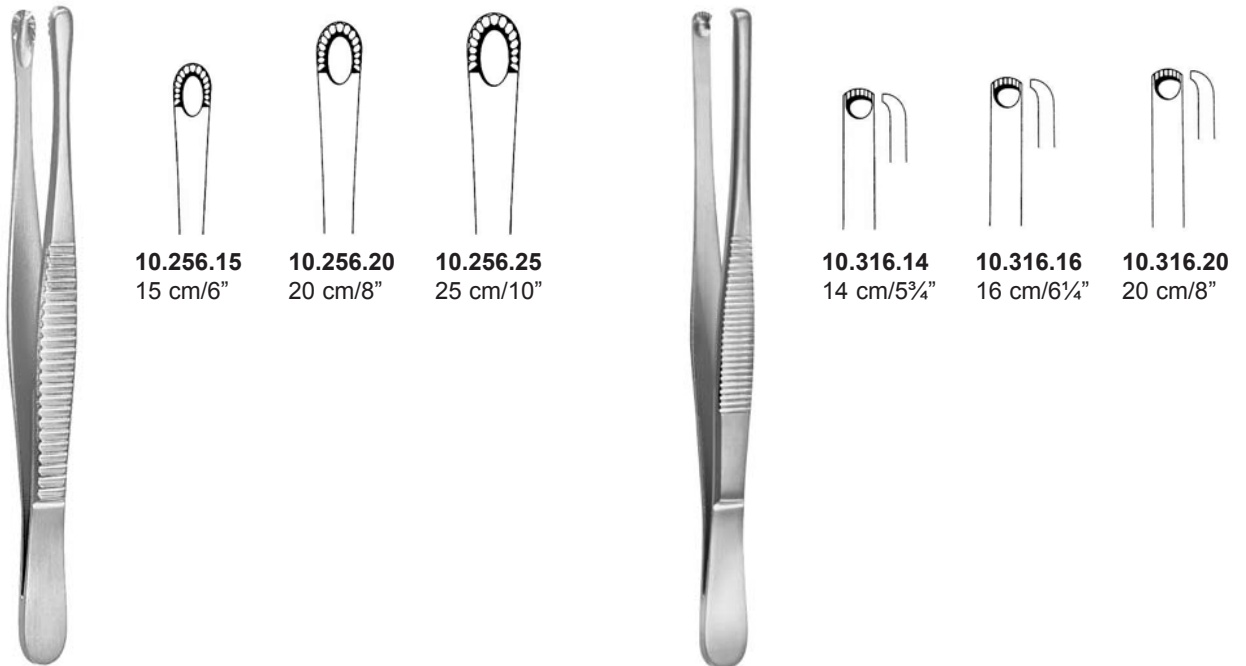

Russ. Mod.

DURANTE

**10.256.15**  
15 cm/6"

**10.256.20**  
20 cm/8"

**10.256.25**  
25 cm/10"

**10.316.14**  
14 cm/5<sup>3</sup>/<sub>4</sub>"

**10.316.16**  
16 cm/6<sup>1</sup>/<sub>4</sub>"

**10.316.20**  
20 cm/8"



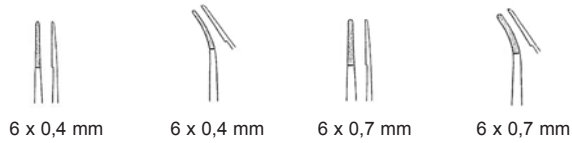

15 cm/6"	<b>10.564.15</b>	<b>10.565.15</b>	<b>10.566.15</b>	<b>10.567.15</b>
18 cm/7"	<b>10.564.18</b>	<b>10.565.18</b>	<b>10.566.18</b>	<b>10.567.18</b>
21 cm/8¼"			<b>10.566.21</b>	<b>10.567.21</b>
23 cm/9"			<b>10.566.23</b>	<b>10.567.23</b>

15 cm/6"	<b>11.578.15</b>	<b>11.579.15</b>	<b>11.580.15</b>	<b>11.581.15</b>
18 cm/7"	<b>11.578.18</b>	<b>11.579.18</b>	<b>11.580.18</b>	<b>11.581.18</b>
21 cm/8¼"			<b>11.580.21</b>	<b>11.581.21</b>

Titan  
 Titanium  
 Titane  
 Titanio  
 Titanio

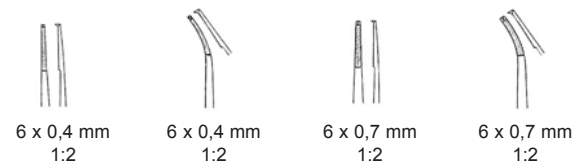

15 cm/6"	<b>10.568.15</b>	<b>10.569.15</b>	<b>10.570.15</b>	<b>10.571.15</b>
18 cm/7"	<b>10.568.18</b>	<b>10.569.18</b>	<b>10.570.18</b>	<b>10.571.18</b>
21 cm/8¼"			<b>10.570.21</b>	<b>10.571.21</b>
23 cm/9"			<b>10.570.23</b>	<b>10.571.23</b>

15 cm/6"	<b>11.582.15</b>	<b>11.583.15</b>	<b>11.584.15</b>	<b>11.585.15</b>
18 cm/7"	<b>11.582.18</b>	<b>11.583.18</b>	<b>11.584.18</b>	<b>11.585.18</b>
21 cm/8¼"			<b>11.584.21</b>	<b>11.585.21</b>

Titan  
 Titanium  
 Titane  
 Titanio  
 Titanio

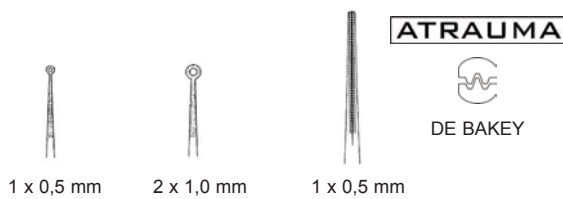

15 cm/6"	<b>10.574.15</b>	<b>10.576.15</b>	<b>10.589.15</b>
18 cm/7"	<b>10.574.18</b>	<b>10.576.18</b>	<b>10.589.18</b>
21 cm/8¼"	<b>10.574.21</b>	<b>10.576.21</b>	<b>10.589.21</b>
23 cm/9"	<b>10.574.23</b>	<b>10.576.23</b>	

15 cm/6"	<b>11.586.15</b>	<b>11.588.15</b>	<b>11.590.15</b>
18 cm/7"	<b>11.586.18</b>	<b>11.588.18</b>	<b>11.590.18</b>
21 cm/8¼"	<b>11.586.21</b>	<b>11.588.21</b>	<b>11.590.21</b>

Titan  
 Titanium  
 Titane  
 Titanio  
 Titanio

**ATRAUMA**



DE BAKEY



DE BAKEY

1,0 mm

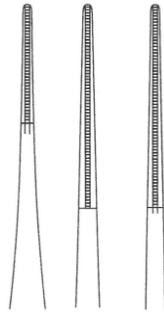

1,5 mm

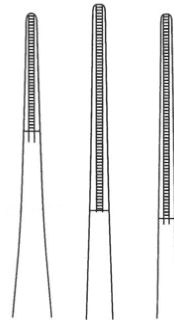

1,8 mm

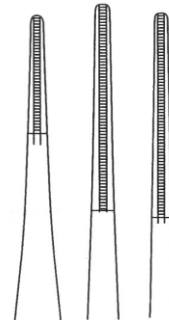

15 cm/6"  
 20 cm/8"  
 24 cm/9½"

**11.290.15**  
**11.290.20**  
**11.290.24**

**11.300.16**  
**11.300.20**  
**11.300.24**

**11.302.16**  
**11.302.20**  
**11.302.24**

Titan  
 Titanium  
 Titane  
 Titanio  
 Titanio

2,0 mm

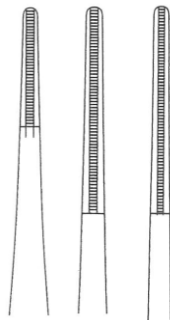

2,8 mm

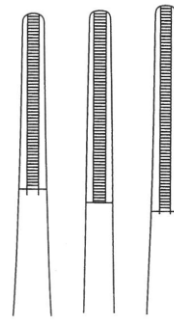

15 cm/6"  
 20 cm/8"  
 24 cm/9½"

**11.292.15**  
**11.292.20**  
**11.292.24**

**11.298.15**  
**11.298.20**  
**11.298.24**

Titan  
 Titanium  
 Titane  
 Titanio  
 Titanio

**ATRAUMA**



DE BAKEY



DE BAKEY

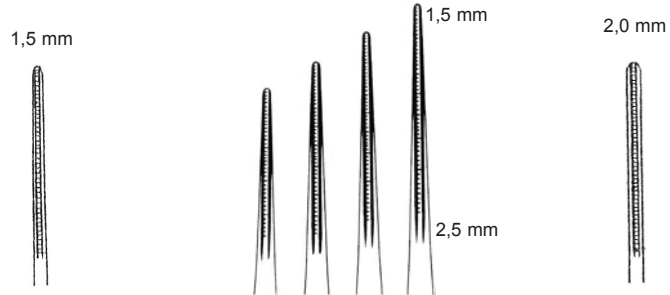

16 cm/6 $\frac{1}{4}$ "	<b>11.322.16</b>	<b>11.306.16</b>	<b>11.324.15</b>
20 cm/8"	<b>11.322.20</b>	<b>11.306.20</b>	<b>11.324.20</b>
24 cm/9 $\frac{1}{2}$ "	<b>11.322.24</b>	<b>11.306.24</b>	<b>11.324.24</b>
30 cm/12"	<b>11.322.30</b>	<b>11.306.30</b>	<b>11.324.30</b>

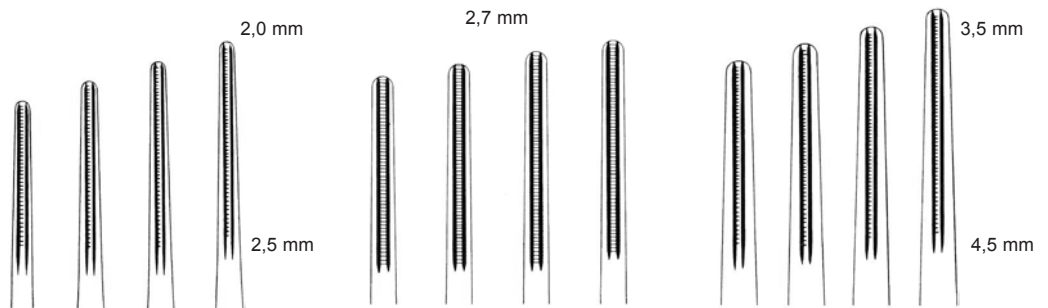

16 cm/6 $\frac{1}{4}$ "	<b>11.308.16</b>	<b>11.304.16</b>	<b>11.310.16</b>
20 cm/8"	<b>11.308.20</b>	<b>11.304.20</b>	<b>11.310.20</b>
24 cm/9 $\frac{1}{2}$ "	<b>11.308.24</b>	<b>11.304.24</b>	<b>11.310.24</b>
30 cm/12"	<b>11.308.30</b>	<b>11.304.30</b>	<b>11.310.30</b>

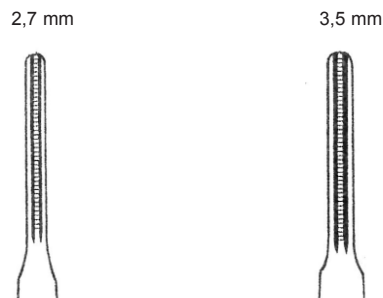

15 cm/6"	<b>11.332.15</b>	<b>11.334.15</b>
20 cm/8"	<b>11.332.20</b>	<b>11.334.20</b>
24 cm/9 $\frac{1}{2}$ "	<b>11.332.24</b>	<b>11.334.24</b>
30 cm/12"	<b>11.332.30</b>	<b>11.334.30</b>
35 cm/14"		<b>11.334.35</b>

**ATRAUMA**



DE BAKEY



DE BAKEY

2,0 mm



16 cm/6¼"	<b>11.309.16</b>
20 cm/8"	<b>11.309.20</b>
24 cm/9½"	<b>11.309.24</b>
30 cm/12"	<b>11.309.30</b>

2,7 mm

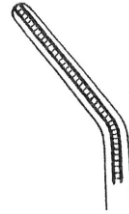

15 cm/6"	<b>11.333.15</b>
20 cm/8"	<b>11.333.20</b>
24 cm/9½"	<b>11.333.24</b>
30 cm/12"	<b>11.333.30</b>

**ATRAUMA**



COOLEY

2,0 mm



<b>COOLEY</b>	
16 cm/6¼"	<b>11.314.16</b>
20 cm/8"	<b>11.314.20</b>
24 cm/9½"	<b>11.314.24</b>

**ATRAUMA**



DE BAKEY

1,0 mm



<b>DE BAKEY</b>	
15 cm/6"	<b>11.315.15</b>
19,5 cm/7¾"	<b>11.315.19</b>
24 cm/9½"	<b>11.315.24</b>

**ATRAUMA**



DE BAKEY

1,5 mm



<b>DE BKAEY-DIETHRICH</b>	
15 cm/6"	<b>11.316.16</b>
19,5 cm/7¾"	<b>11.316.20</b>
24 cm/9½"	<b>11.316.24</b>

**ATRAUMA**



DE BAKEY



**DE BAKEY-ADSON**

12 cm/4<sup>3</sup>/<sub>4</sub>" **11.318.12**  
 15 cm/6" **11.318.15**

**ATRAUMA**



DE BAKEY



**DE BAKEY-GERALD**

15 cm/6" **11.430.15**  
 18 cm/7" **11.430.18**

**ATRAUMA**



DE BAKEY



**DE BAKEY-WHEELER**

15 cm/6" **11.452.15**  
 19,5 cm/7<sup>3</sup>/<sub>4</sub>" **11.456.20**  
 24 cm/9<sup>1</sup>/<sub>2</sub>" **11.456.24**

**ATRAUMA**



COOLEY



**11.462.15**  
 15 cm/6"  
 4 mm

**11.462.24**  
 24 cm/9<sup>1</sup>/<sub>2</sub>"  
 8 mm



GLASSMAN

Mit TC-Einsätzen  
 TC Lined  
 A mors TC  
 Con bocas TC  
 Con morso TC



**ATRAUMA**







DE BAKEY

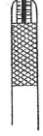

DE BAKEY

	1,5 mm	2,0 mm	2,7 mm	3,5 mm
	6 x 12	6 x 12	6 x 12	6 x 12
				
15 cm/6"	<b>11.404.15</b>	<b>11.412.15</b>	<b>11.414.15</b>	<b>11.416.15</b>
19,5 cm/7¾"	<b>11.404.19</b>	<b>11.412.19</b>	<b>11.414.19</b>	<b>11.416.19</b>
24 cm/9½"	<b>11.404.24</b>	<b>11.412.24</b>	<b>11.414.24</b>	<b>11.416.24</b>

	1,5 mm	2,0 mm	2,7 mm	3,5 mm
	2 x 4	2 x 4	2 x 4	2 x 4
				
15 cm/6"	<b>11.402.15</b>	<b>11.422.15</b>	<b>11.424.15</b>	<b>11.426.15</b>
19,5 cm/7¾"	<b>11.402.20</b>	<b>11.422.19</b>	<b>11.424.19</b>	<b>11.426.19</b>
24 cm/9½"	<b>11.402.24</b>	<b>11.422.24</b>	<b>11.424.24</b>	<b>11.426.24</b>

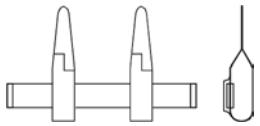
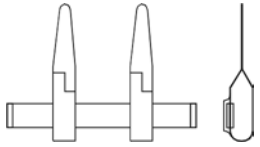
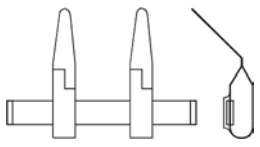
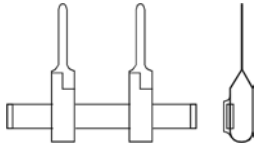
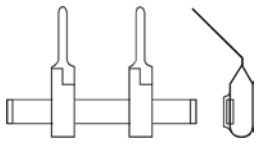
BIEMER - MÜLLER	Maulöffnung Opening of jaw Ouverture des mors Apertura de boca Apertura di morsi	Maullänge Length of jaws Longueur des mors Longitud de boca Lunhg. di morsi	Schließkraft Closing force Force d'occlusio Fuerza de oclusión Forza occlusiva
 <b>12.014.00</b>	4,0 mm	6,0 mm	30 - 40 gms 0,29 - 0,39 Newton
 <b>12.010.00</b>	5,0 mm	9,0 mm	30 - 40 gms 0,29 - 0,39 Newton
 <b>12.011.00</b>	5,0 mm	9,0 mm	30 - 40 gms 0,29 - 0,39 Newton
 <b>12.012.00</b>	5,0 mm	9,0 mm	30 - 40 gms 0,29 - 0,39 Newton
 <b>12.013.00</b>	5,0 mm	9,0 mm	30 - 40 gms 0,29 - 0,39 Newton



BIEMER  
**12.046.14**  
 14,5 cm/5¾"

Anlegepinzette ohne Schloß  
 Applying forceps without lock  
 Pince sans fermeture  
 Pinza sin cierre de resorte  
 Applicatore senza cremagliera



BIEMER  
**12.048.14**  
 14,5 cm/5¾"

Anlegepinzette mit Schloß  
 Applying forceps with lock  
 Pince avec fermeture  
 Pinza con cierre de resorte  
 Applicatore con cremagliera

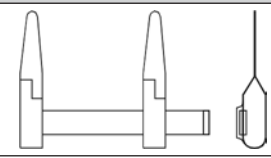
BIEMER	Maulöffnung Opening of jaw Ouverture des mors Apertura de boca Apertura di morsi	Maullänge Length of jaws Longuer des mors Longitud de boca Lunhg. di morsi	Schließkraft Closing force Force d'occlusio Fuerza de oclusión Forza occlusiva
 <b>12.016.00</b>	5,0 mm	9,0 mm	30 - 40 gms 0,29 - 0,39 Newton



**12.016.00**

**12.050.14**

BIEMER Approximator Set aus Artikel 12.016.00 & 12.044.14  
 BIEMER Approximator set consisting of 12.016.00 & 12.044.14  
 BIEMER Approximateurs set 12.016.00 & 12.044.14  
 BIEMER Aproximadores set 12.016.00 & 12.044.14  
 BIEMER Approssimatori set 12.016.00 & 12.044.14

Anlegepinzette ohne Schloß  
 Applying forceps without lock  
 Pince sans fermeture  
 Pinza sin cierre de resorte  
 Applicatore senza cremagliera



**12.024.00**

BIEMER Approximator mit Schlüssel 12.041.01  
 BIEMER Approximator with key 12.041.01  
 BIEMER Approximateurs avec clef 12.041.01  
 BIEMER Aproximadores con llave 12.041.01  
 BIEMER Approssimatori con chiave 12.041.01



**12.04100**

BIEMER Approximator mit Schlüssel 12.041.01 und Nadeln 12.041.02  
 BIEMER Approximator with key 12.041.01 and needles 12.041.02  
 BIEMER Approximateurs avec clef 12.041.01 et d'aiguilles de rechange 12.041.02  
 BIEMER Aproximadores con llave 12.041.01 y de agujas de rechange 12.041.02  
 BIEMER Approssimatori con chiave 12.041.01 e di aghi di ricambio 12.041.02



**12.041.01**

Schlüssel allein  
 Key only  
 Clef seule  
 Llave suelta  
 Sola chiave

**12.041.02**

1 Paar Ersatznadeln  
 1 Pair of spare needles  
 1 paire d'aiguilles de rechange  
 1 par de agujas de rechange  
 1 paio di aghi di ricambio



**BIEMER  
 12.044.14  
 14,5 cm/5¾"**

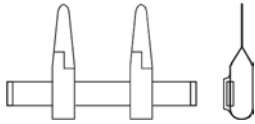
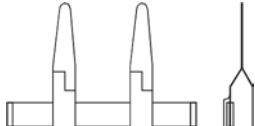
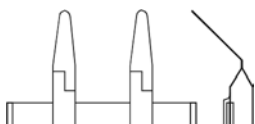
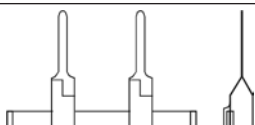

MÜLLER	Ø	Schließkraft Closing force Force d'occlusio Fuerza de oclusión Forza occlusiva
 <b>12.028.01</b>	1 mm	25 - 30 gms 0,25 - 0,29 Newton
 <b>12.028.02</b>	2 mm	25 - 30 gms 0,25 - 0,29 Newton
 <b>12.028.03</b>	3 mm	25 - 30 gms 0,25 - 0,29 Newton
 <b>12.028.04</b>	4 mm	25 - 30 gms 0,25 - 0,29 Newton

Anlegepinzette ohne Schloß  
 Applying forceps without lock  
 Pince sans fermeture  
 Pinza sin cierre de resorte  
 Applicatore senza cremagliera

Anlegepinzette mit Schloß  
 Applying forceps with lock  
 Pince avec fermeture  
 Pinza con cierre de resorte  
 Applicatore con cremagliera









BIEMER  
**12.046.14**  
 14,5 cm/5¾"

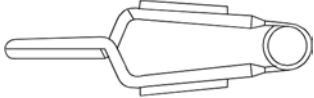
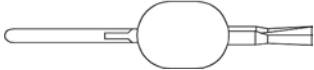
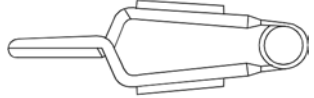

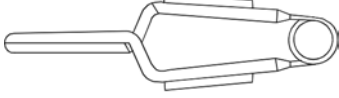

BIEMER  
**12.048.14**  
 14,5 cm/5¾"

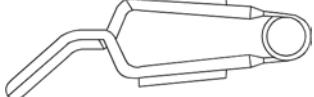
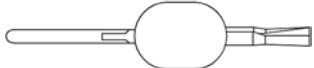
Gefäßclips - für temporären Gebrauch  
 Vessels Clips - for temporary occlusion  
 Serre-Fines - pour occlusion temporaire  
 Clips vasculares - para oclusión temporal  
 Pinze - per occlusioni temporari

MÜLLER		Schließkraft Closing force Force d'occlusio Fuerza de oclusión Forza occlusiva
	<b>12.030.50</b>	50 gms 0,49 Newton
		<b>12.030.80</b>
	<b>12.031.50</b>	50 gms 0,49 Newton
		<b>12.031.80</b>
	<b>12.033.50</b>	50 gms 0,49 Newton
		<b>12.033.80</b>
	<b>12.035.50</b>	50 gms 0,49 Newton
		<b>12.035.80</b>
	<b>12.037.50</b>	50 gms 0,49 Newton
		<b>12.037.80</b>

Gefäßclips - für temporären Gebrauch  
 Vessels Clips - for temporary occlusion  
 Serre-Fines - pour occlusion temporaire  
 Clips vasculares - para oclusión temporal  
 Pinze - per occlusioni temporari

BIEMER	Maulöffnung Opening of jaw Ouverture des mors Apertura de boca Apertura di morsi	Maullänge Length of jaws Longueur des mors Longitud de boca Lunhg. di morsi	Schließkraft Closing force Force d'occlusio Fuerza de oclusión Forza occlusiva
 <b>12.040.01</b>	4,0 mm	6,0 mm	30 - 40 gms 0,29 - 0,39 Newton
 <b>12.040.02</b>	5,0 mm	9,0 mm	30 - 40 gms 0,29 - 0,39 Newton
 <b>12.040.03</b>	5,0 mm	9,0 mm	30 - 40 gms 0,29 - 0,39 Newton



BIEMER



½

BIEMER  
**12.046.14**  
 14,5 cm/5¾"

Anlegepinzette ohne Schloß  
 Applying forceps without lock  
 Pince sans fermeture  
 Pinza sin cierre de resorte  
 Applicatore senza cremagliera



½





BIEMER  
**12.048.14**  
 14,5 cm/5¾"

Anlegepinzette mit Schloß  
 Applying forceps with lock  
 Pince avec fermeture  
 Pinza con cierre de resorte  
 Applicatore con cremagliera

Gefäßclips - für temporären Gebrauch  
 Vessels Clips - for temporary occlusion  
 Serre-Fines - pour occlusion temporaire  
 Clips vasculares - para oclusión temporal  
 Pinze - per occlusioni temporari

**dimeda**®

SURGICAL INSTRUMENTS

MEHDORN	Maullänge Length of jaws Longuer des mors Longitud de boca Lunhg. di morsi	Schließkraft Closing force Force d'occlusio Fuerza de oclusón Forza occlusiva
 <b>12.043.01</b>	4 x 1,0 mm	10 - 15 gms 0,10 - 0,15 Newton
 <b>12.043.02</b>	4 x 1,4 mm	10 - 15 gms 0,10 - 0,15 Newton
 <b>12.043.03</b>	6 x 1,0 mm	10 - 15 gms 0,10 - 0,15 Newton
 <b>12.043.04</b>	6 x 1,4 mm	15 - 20 gms 0,15 - 0,20 Newton

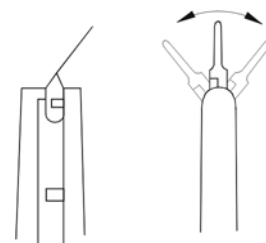





Anlegepinzette ohne Schloß  
 Applying forceps without lock  
 Pince sans fermeture  
 Pinza sin cierre de resorte  
 Applicatore senza cremagliera

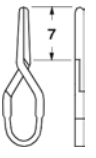
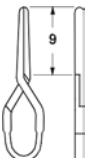
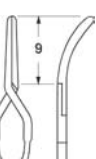

MEHDORN  
**12.050.15**  
 15 cm/6"

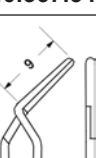
Gefäßclips - für temporären Gebrauch  
 Vessels Clips - for temporary occlusion  
 Serre-Fines - pour occlusion temporaire  
 Clips vasculares - para oclusión temporal  
 Pinze - per occlusioni temporari

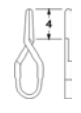
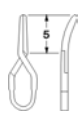
STANDARD	Schließkraft Closing force Force d'occlusio Fuerza de oclusión Forza occlusiva
	120-150 gms.
<b>40.567.40</b>	
	120-150 gms.
<b>40.567.50</b>	
	120-150 gms.
<b>40.567.52</b>	
	120-150 gms.
<b>40.567.54</b>	
	120-150 gms.
<b>40.567.46</b>	

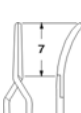
MINI	Schließkraft Closing force Force d'occlusio Fuerza de oclusión Forza occlusiva
	70-100 gms.
<b>40.567.10</b>	
	70-100 gms.
<b>40.567.12</b>	
	70-100 gms.
<b>40.567.20</b>	
	70-100 gms.
<b>40.567.22</b>	

Anlegepinzette für STANDARD & MINI Clips  
 Applying forceps for STANDARD & MINI Clips  
 Pince pour STANDARD & MINI serre-fines  
 Pinza de resorte para STANDARD & MINI clips  
 Applicatore per STANDARD & MINI pinze

**dimed**<sup>®</sup>

SURGICAL INSTRUMENTS



**40.776.18**

Anlegezange gerade, mit Sperre  
 Applying Forceps straight, with ratchet  
 Pince avec fermeture directement  
 Pinza con cierre de resorte derecho  
 Applicatore con cremagliera diritto

MINI	STANDARD
<b>40.776.18</b>	<b>40.778.18</b>
18 cm/7"	18 cm/7"

Anlegezange gerade, mit Sperre, drehbar  
 Applying Forceps straight, with ratchet, rotatable  
 Pince avec fermeture directement, rotatif  
 Pinza con cierre de resorte derecho, rotativo  
 Applicatore con cremagliera diritto, rotativo

MINI	STANDARD
<b>40.776.20</b>	<b>40.778.20</b>
20 cm/7¾"	20 cm/7¾"



**40.772.21**

Anlegezange gerade, mit Sperre  
 Applying Forceps straight, with ratchet  
 Pince avec fermeture directement  
 Pinza con cierre de resorte derecho  
 Applicatore con cremagliera diritto

MINI		STANDARD	
17 cm/6¾"	<b>40.772.17</b>	17 cm/6¾"	<b>40.774.17</b>
21 cm/8¼"	<b>40.772.21</b>	21 cm/8¼"	<b>40.774.21</b>
23 cm/9"	<b>40.772.23</b>	23 cm/9"	<b>40.774.23</b>

Anlegezange gerade, mit Sperre, drehbar  
 Applying Forceps straight, with ratchet, rotatable  
 Pince avec fermeture directement, rotatif  
 Pinza con cierre de resorte derecho, rotativo  
 Applicatore con cremagliera diritto, rotativo

MINI		STANDARD	
17 cm/6¾"	<b>40.772.18</b>	17 cm/6¾"	<b>40.774.19</b>
21 cm/8¼"	<b>40.772.31</b>	21 cm/8¼"	<b>40.774.22</b>
23 cm/9"	<b>40.772.24</b>	23 cm/9"	<b>40.774.24</b>

**ATRAUMA**



DE BAKEY



DE BAKEY



DE BAKEY-SATINSKY  
**12.059.07**  
 7 cm/2¾"



DE BAKEY-CAROTIS  
**12.061.09**  
 9 cm/3½"



DE BAKEY-SATINSKY  
**12.063.10**  
 10 cm/4"



GLOVER  
**12.065.06**  
 5 cm/2"



DE BAKEY  
**12.070.50**  
 5 cm/2"



DE BAKEY  
**12.071.50**  
 5 cm/2"



GREGORY

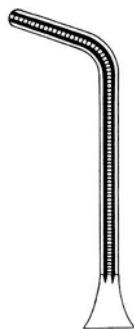

**12.087.09**  
 9 cm/3½"

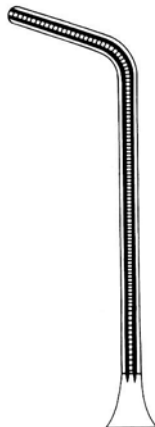

**12.087.11**  
 11 cm/4¼"



SANTULLI  
**12.089.07**  
 7 cm/2¾"

**ATRAUMA**



DE BAKEY

DE BAKEY-  
DIETRICH



**12.078.10**

**12.078.14**

**12.078.20**

**12.079.10**

**12.079.14**

**12.079.20**

Länge

Length

Longueur

Longitud

Lunghezza

Maullänge

Jaw length

Longueur des mors

Longitud de la boca

Lunghezza del morso

Gewicht

Weight

Poids

Peso

Peso

Schließdruck

Closing pressure

Pression d'occlusion

Presión de cierre

Pression di chiusura

5 cm/2"

5 cm/2"

6 cm/2½"

5 cm/2"

5 cm/2"

6 cm/2½"

10 mm

14 mm

20 mm

10 mm

14 mm

20 mm

3 gr.

3 gr.

3 gr.

3 gr.

3 gr.

3 gr.

180 gr.

180 gr.

180 gr.

180 gr.

180 gr.

180 gr.



DIETRICH

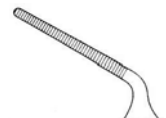
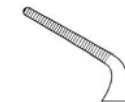

**12.082.08**

**12.082.12**

**12.082.16**

**12.083.08**

**12.083.12**

**12.083.16**

Länge

Length

Longueur

Longitud

Lunghezza

Maullänge

Jaw length

Longueur des mors

Longitud de la boca

Lunghezza del morso

Gewicht

Weight

Poids

Peso

Peso

Schließdruck

Closing pressure

Pression d'occlusion

Presión de cierre

Pression di chiusura

5 cm/2"

5 cm/2"

6 cm/2½"

5 cm/2"

5 cm/2"

6 cm/2½"

8 mm

12 mm

20 mm

8 mm

12 mm

20 mm

3 gr.

3 gr.

3 gr.

3 gr.

3 gr.

3 gr.

50 gr.

50 gr.

50 gr.

50 gr.

50 gr.

50 gr.



**ATRAUMA**



DE BAKEY



DE BAKEY



**12.092.07**  
7,5 cm/3"



**12.092.08**  
8,5 cm/3½"



**12.092.10**  
10,5 cm/4¼"



**12.092.12**  
12 cm/4¾"



**12.093.07**  
7 cm/2¾"



**12.093.08**  
8 cm/3¼"



**12.093.10**  
10 cm/4"

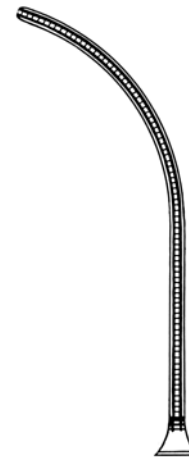

**12.093.12**  
11,5 cm/4¾"

**ATRAUMA**



DE BAKEY

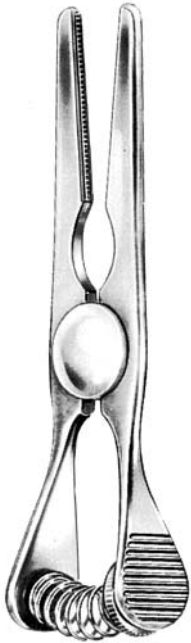

GLOVER



**12.096.06**  
6 cm/2½"



**12.096.07**  
7 cm/2¾"



**12.096.09**  
9 cm/3½"



**12.096.11**  
11 cm/4½"



**12.097.06**  
6,5 cm/2½"



**12.097.07**  
7 cm/2¾"



**12.097.09**  
8,5 cm/3½"



**12.097.11**  
10,5 cm/4½"

**ATRAUMA**



COOLEY



COOLEY

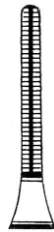

**12.084.08**  
8 cm/3"

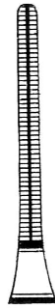

**12.084.09**  
9 cm/3½"

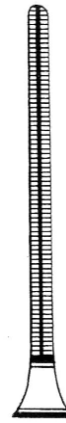

**12.084.10**  
10,5 cm/4¼"

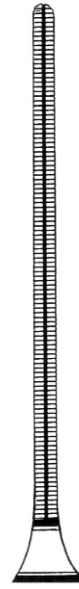

**12.084.12**  
12,5 cm/5"

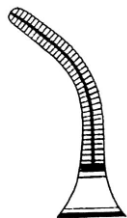

**12.085.08**  
7,5 cm/3"

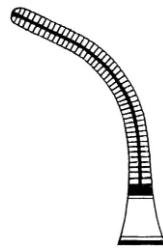



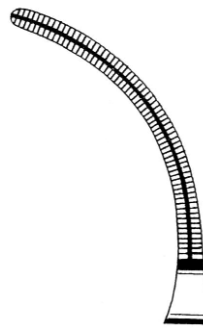

**12.085.09**  
8,5 cm/3¼"

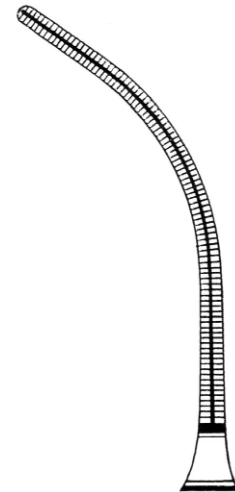





**12.085.10**  
9,5 cm/3¾"







**12.085.12**  
11,5 cm/4½"

					
	3 cm	3,5 cm	4 cm	5 cm	
Vena	<b>12.132.30</b>	<b>12.132.35</b>	<b>12.132.40</b>	<b>12.132.50</b>	Titan Titanium Titane Titanio
Artria	<b>12.142.30</b>	<b>12.142.35</b>	<b>12.142.40</b>	<b>12.142.50</b>	



					
	3 cm	3,5 cm	4 cm	5 cm	
Vena	<b>12.133.30</b>	<b>12.133.35</b>	<b>12.133.40</b>	<b>12.133.50</b>	Titan Titanium Titane Titanio
Artria	<b>12.143.30</b>	<b>12.143.35</b>	<b>12.143.40</b>	<b>12.143.50</b>	

					
	3 cm	3,5 cm	4 cm	5 cm	
Vena	<b>12.135.30</b>	<b>12.135.35</b>	<b>12.135.40</b>	<b>12.135.50</b>	Titan Titanium Titane Titanio
Artria	<b>12.145.30</b>	<b>12.145.35</b>	<b>12.145.40</b>	<b>12.145.50</b>	

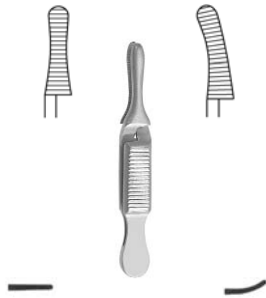

**DIEFFENBACH**

3,5 cm/1½"	<b>12.102.04</b>	<b>12.103.04</b>
5 cm/2"	<b>12.102.05</b>	<b>12.103.05</b>



<b>12.070.35</b>	<b>12.071.35</b>	<b>12.070.45</b>	<b>12.071.45</b>
3,5 cm/1½"	3,5 cm/1½"	4,5 cm/1¾"	4,5 cm/1¾"

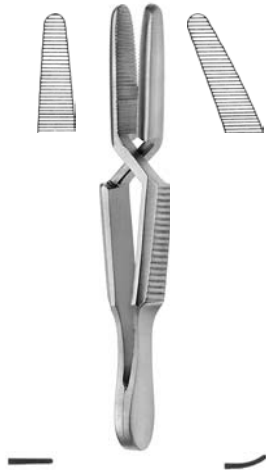

**DIEFFENBACH**

5,8 cm/2¼"	<b>12.104.06</b>	<b>12.105.06</b>
------------	------------------	------------------

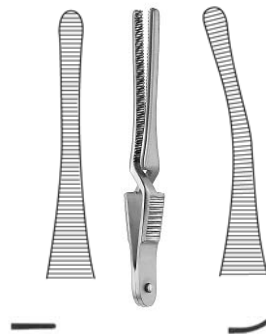

**JOHN-HOPKINS**

5 cm/2"	<b>12.110.50</b>	<b>12.111.50</b>
5,5 cm/2¼"	<b>12.110.55</b>	<b>12.111.55</b>
6,5 cm/2½"	<b>12.110.65</b>	<b>12.111.65</b>
7 cm/2¾"	<b>12.110.70</b>	<b>12.111.70</b>
7,5 cm/3"	<b>12.110.75</b>	<b>12.111.75</b>
9 cm/3½"	<b>12.110.90</b>	<b>12.111.90</b>

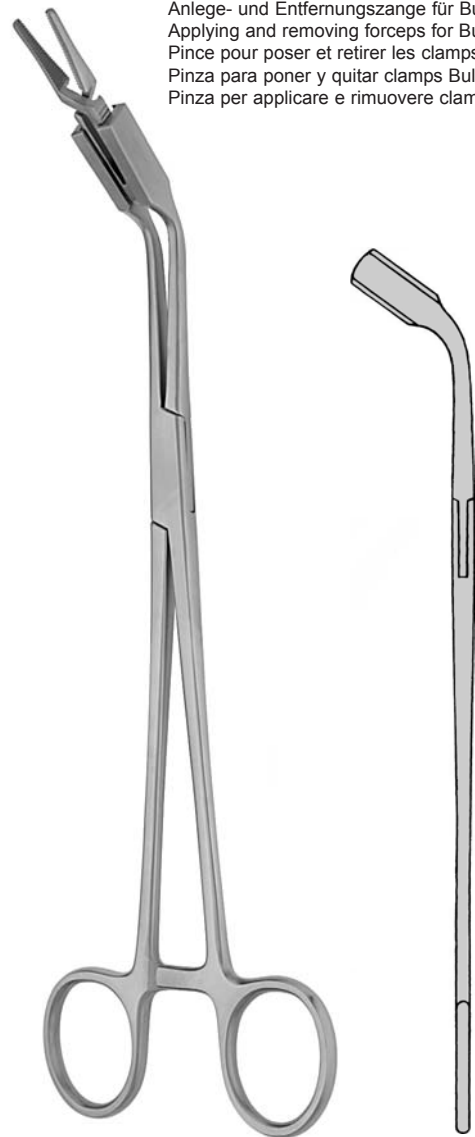

**12.091.23**  
 23 cm/8¼"

Anlege- und Entfernungs-  
 zange für Bulldogklemmen  
 Applying and removing forceps  
 for Bulldog clamps  
 Pince pour poser et retirer  
 les clamps Bulldog  
 Pinza para poner y quitar  
 clamps Bulldog  
 Pinza per applicare e  
 rimuovere clamps



DE BAKEY-HESS

Maullänge  
Jaw length  
Longueur des mors  
Longitud de la boca  
Lunghhezza del morso

<b>12.112.20</b>	<b>12.112.30</b>
20 mm	30 mm

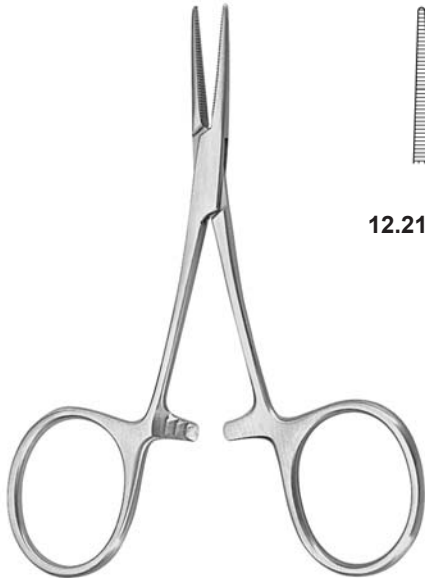

HARTMANN  
 10 cm/4"

12.210.10



12.211.10



12.212.10



1:2

12.213.10



1:2

Fadenklemme  
 Ligature Forceps  
 Pince à ligatures  
 Pinza para hilos  
 Pinza per legature

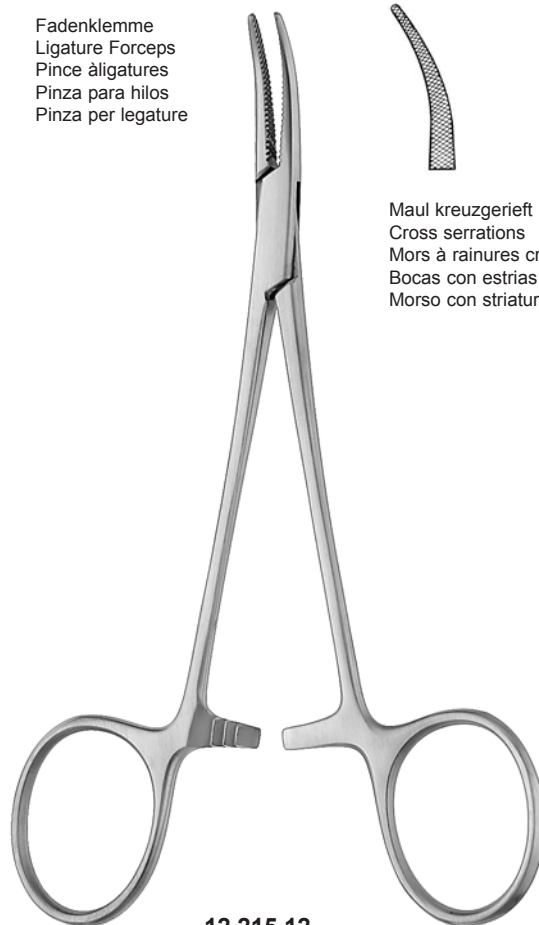

12.215.12  
 12 cm/4¾"



Maul kreuzgerieft  
 Cross serrations  
 Mors à rainures croisées  
 Bocas con estrias cruzadas  
 Morso con striatura cruciforme



HALSTEAD-MOSQUITO

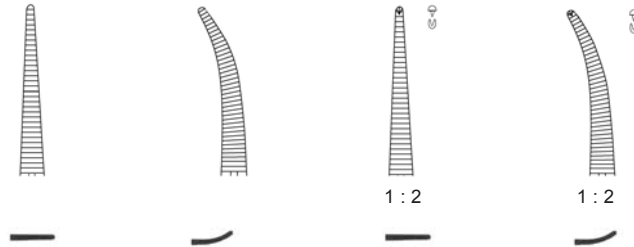

12,5 cm/5"	<b>12.220.12</b>	<b>12.221.12</b>	<b>12.230.12</b>	<b>12.231.12</b>
12,5 cm/5"	<b>12.224.12</b>	<b>12.225.12</b>	<b>12.234.12</b>	<b>12.235.12</b>
14 cm/5½"	<b>12.220.14</b>	<b>12.221.14</b>	<b>12.230.14</b>	<b>12.231.14</b>
18 cm/7"	<b>12.220.18</b>	<b>12.221.18</b>	<b>12.230.18</b>	<b>12.231.18</b>
21 cm/8¼"	<b>12.220.21</b>	<b>12.221.21</b>	<b>12.230.21</b>	<b>12.231.21</b>

Titan  
 Titanium  
 Titane  
 Titanio  
 Titanio



HALSTEAD-MOSQUITO micro

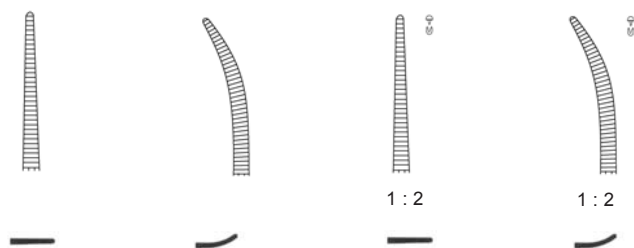

10 cm/4"	<b>12.222.10</b>	<b>12.223.10</b>	<b>12.232.10</b>	<b>12.233.10</b>
12,5 cm/5"	<b>12.222.12</b>	<b>12.223.12</b>	<b>12.232.12</b>	<b>12.233.12</b>



Titan  
 Titanium  
 Titane  
 Titanio  
 Titanio

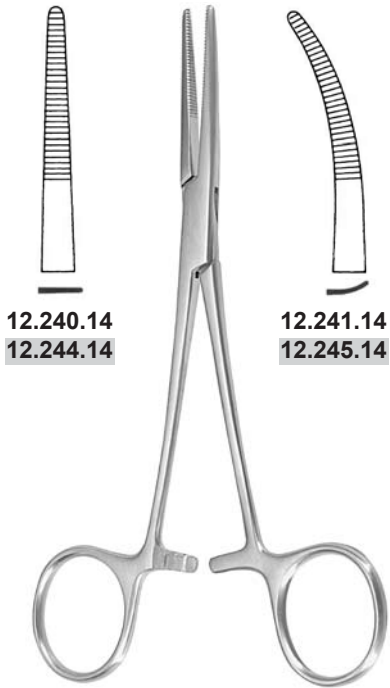

12.240.14  
 12.244.14

12.241.14  
 12.245.14

**KELLY**  
 14 cm/5½"

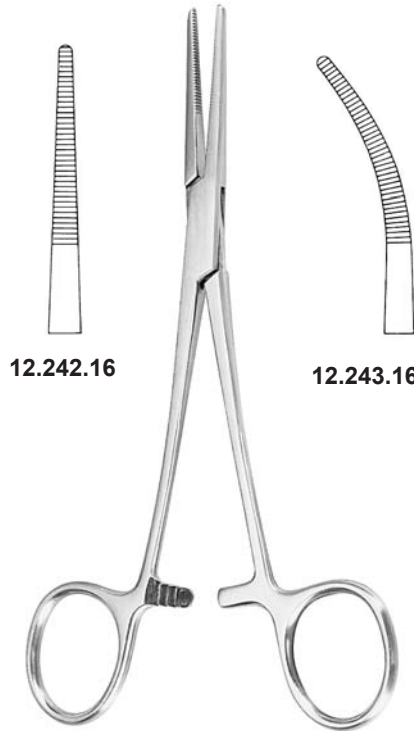

12.242.16

12.243.16

**KELLY-RANKIN**  
 16 cm/6¼"



**CRILE**  
 14 cm/5½"

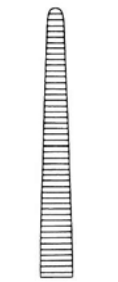

12.250.14  
 12.254.14



12.251.14  
 12.255.14

Titan  
 Titanium  
 Titane  
 Titanio  
 Titanio



12.260.14

1 : 2



12.261.14

1 : 2



CRILE-RANKIN  
 16 cm/6¼"



12.262.16



12.263.16



1:2  
 12.264.16

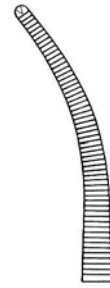

1:2  
 12.265.16

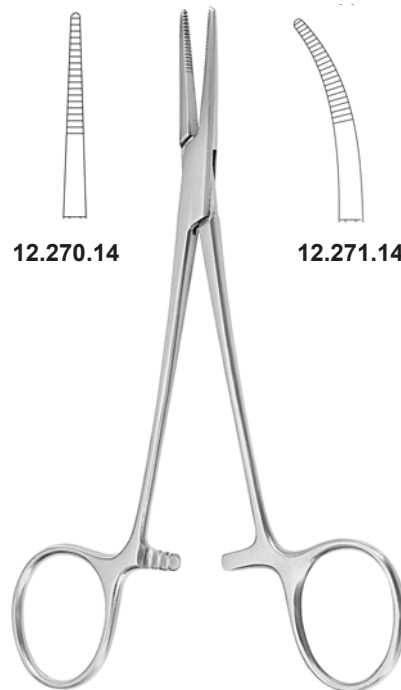

12.270.14



12.271.14

PROVIDENCE-HOSPITAL  
 14 cm/5½"



ROCHESTER-PEAN

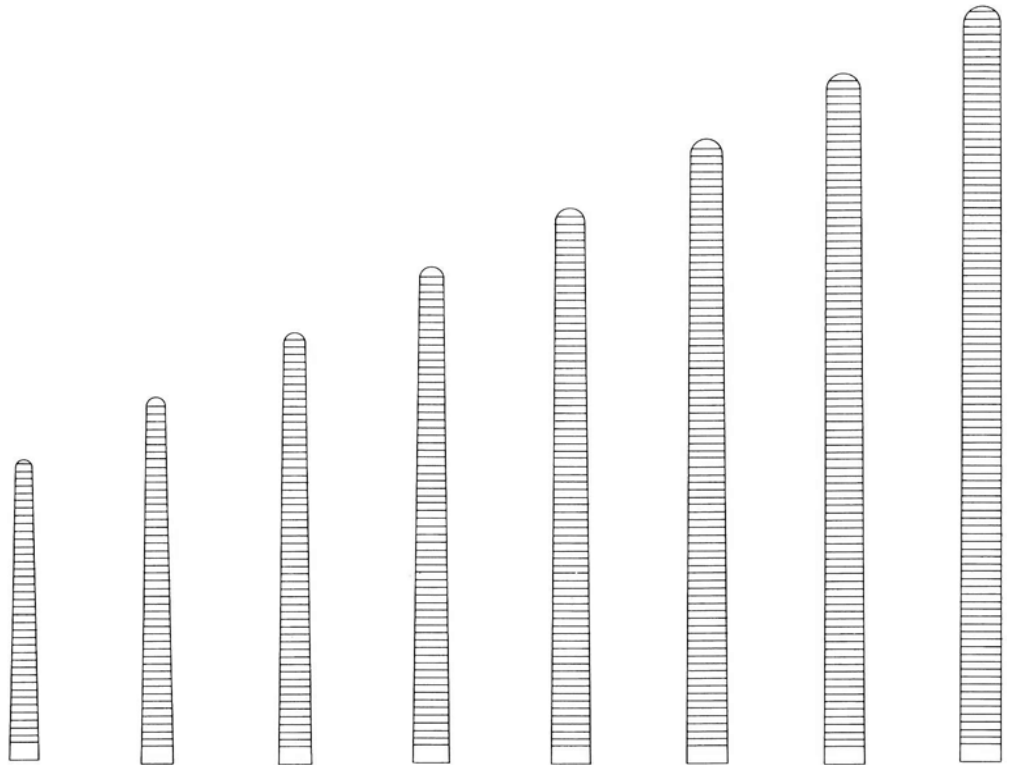

- |                  |                  |                  |                  |                  |                  |                  |                  |
|------------------|------------------|------------------|------------------|------------------|------------------|------------------|------------------|
| <b>12.310.14</b> | <b>12.310.16</b> | <b>12.310.18</b> | <b>12.310.20</b> | <b>12.310.22</b> | <b>12.310.24</b> | <b>12.310.26</b> | <b>12.310.30</b> |
| 14 cm/5½"        | 16 cm/6¼"        | 18 cm/7"         | 20 cm/8"         | 22 cm/8¾"        | 24 cm/9½"        | 26 cm/10¼"       | 30 cm/12"        |

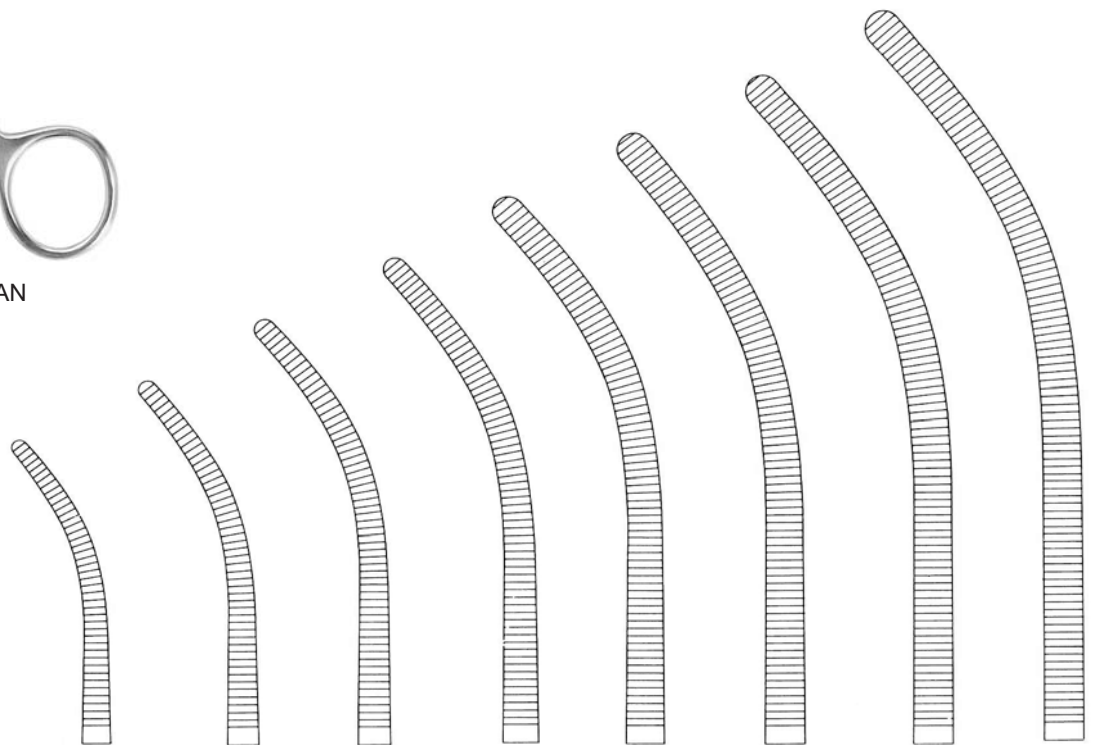

- |                  |                  |                  |                  |                  |                  |                  |                  |
|------------------|------------------|------------------|------------------|------------------|------------------|------------------|------------------|
| <b>12.311.14</b> | <b>12.311.16</b> | <b>12.311.18</b> | <b>12.311.20</b> | <b>12.311.22</b> | <b>12.311.24</b> | <b>12.311.26</b> | <b>12.311.30</b> |
| 14 cm/5½"        | 16 cm/6¼"        | 18 cm/7"         | 20 cm/8"         | 22 cm/8¾"        | 24 cm/9½"        | 26 cm/10¼"       | 30 cm/12"        |



ROCHESTER-OCHSNER

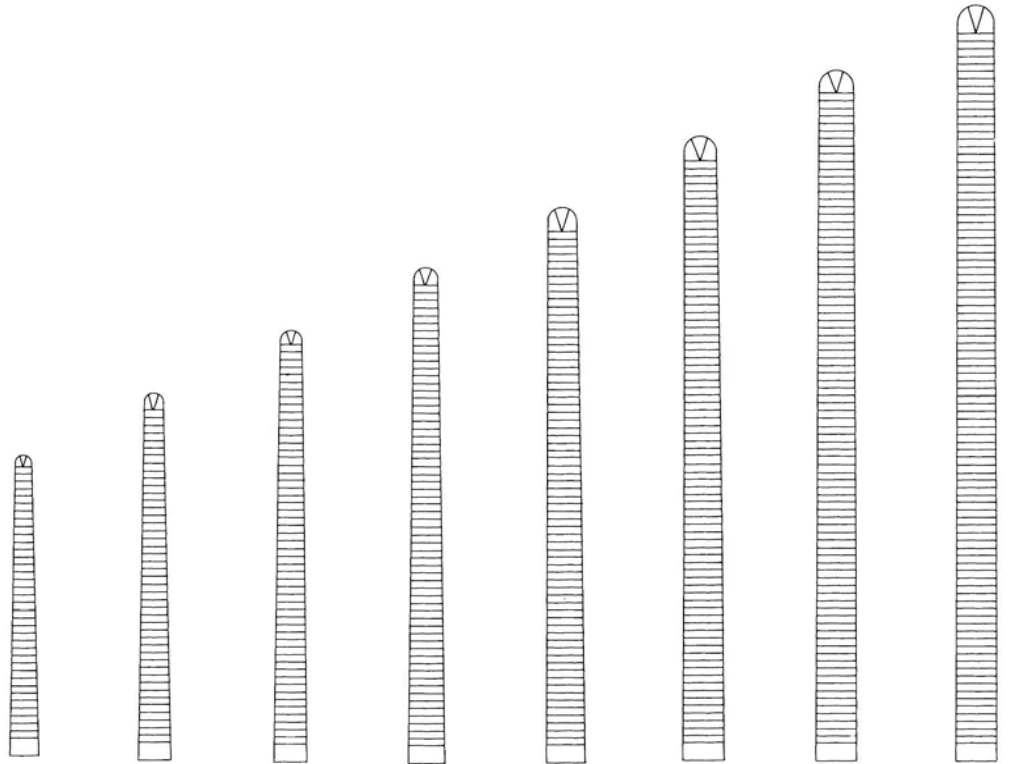

<b>12.320.14</b>	<b>12.320.16</b>	<b>12.320.18</b>	<b>12.320.20</b>	<b>12.320.22</b>	<b>12.320.24</b>	<b>12.320.26</b>	<b>12.320.30</b>
14 cm/5½"	16 cm/6¼"	18 cm/7"	20 cm/8"	22 cm/8¾"	24 cm/9½"	26 cm/10¼"	30 cm/12"

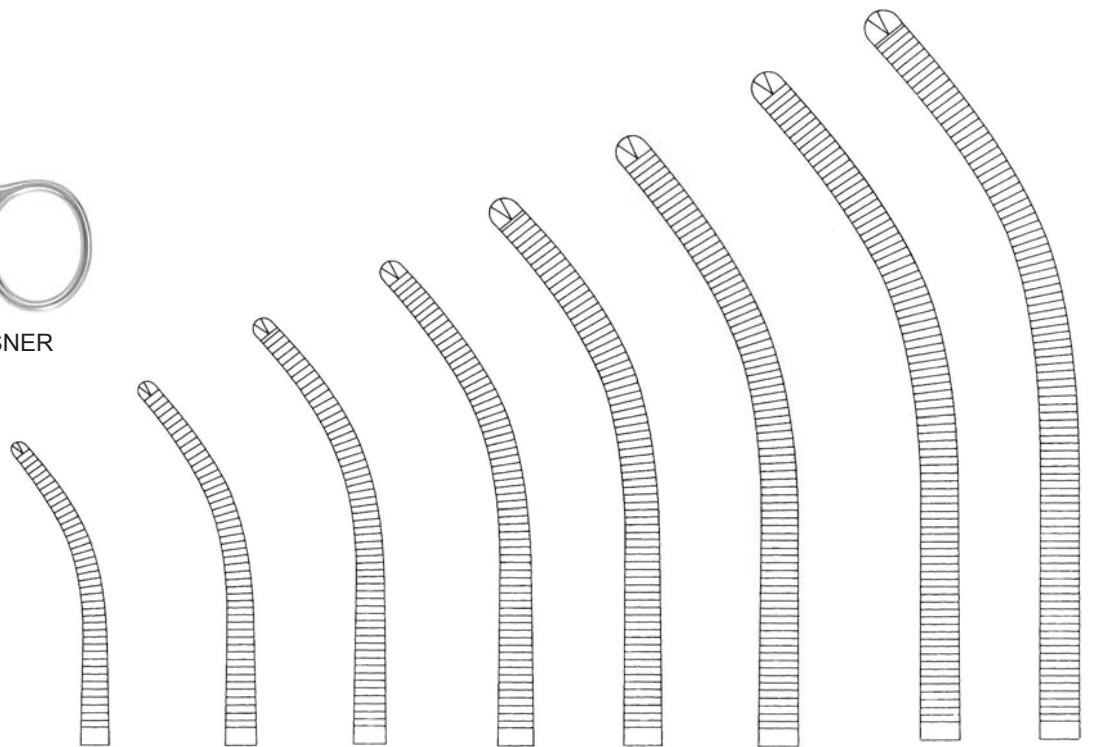

<b>12.321.14</b>	<b>12.321.16</b>	<b>12.321.18</b>	<b>12.321.20</b>	<b>12.321.22</b>	<b>12.321.24</b>	<b>12.321.26</b>	<b>12.321.30</b>
14 cm/5½"	16 cm/6¼"	18 cm/7"	20 cm/8"	22 cm/8¾"	24 cm/9½"	26 cm/10¼"	30 cm/12"

Grazilles Modell  
 Delicate pattern  
 Modèle gracile  
 Modelo delicado  
 Modello delicato



PEAN



**12.312.13**  
 13 cm/5"



**12.312.14**  
 14 cm/5½"



**12.312.16**  
 16 cm/6¼"



**12.313.13**  
 13 cm/5"



**12.313.14**  
 14 cm/5½"

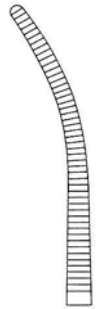

**12.313.16**  
 16 cm/6¼"

Grazilles Modell  
 Delicate pattern  
 Modèle gracile  
 Modelo delicado  
 Modello delicato



KOCHER  
 1:2



**12.322.13**  
 13 cm/5"



**12.322.14**  
 14 cm/5½"



**12.322.16**  
 16 cm/6¼"



**12.323.13**  
 13 cm/5"



**12.323.14**  
 14 cm/5½"

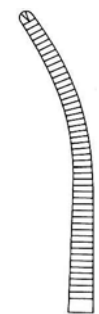

**12.323.16**  
 16 cm/6¼"



PEAN-NIPPON



**12.316.14**  
14 cm/5½"



**12.316.16**  
16 cm/6¼"

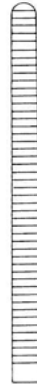

**12.316.18**  
18 cm/7"

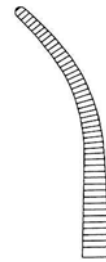

**12.317.14**  
14 cm/5½"



**12.317.16**  
16 cm/6¼"



**12.317.18**  
18 cm/7"



KOCHER-NIPPON

1 : 2



**12.326.14**  
14 cm/5½"



**12.326.16**  
16 cm/6¼"



**12.326.18**  
18 cm/7"

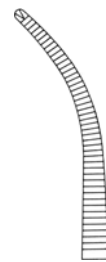

**12.327.14**  
14 cm/5½"



**12.327.16**  
16 cm/6¼"

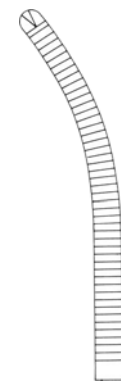

**12.327.18**  
18 cm/7"



SPENCER-WELLS



**12.330.13**  
13 cm/5"



**12.330.14**  
14 cm/5½"



**12.330.15**  
15 cm/6"



**12.330.18**  
18 cm/7"



**12.330.20**  
20 cm/8"



**12.331.13**  
13 cm/5"



**12.331.14**  
14 cm/5½"



**12.331.15**  
15 cm/6"



**12.331.18**  
18 cm/7"

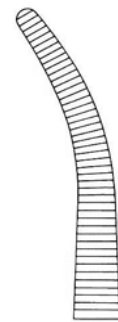

**12.331.20**  
20 cm/8"



ROCHESTER-CARMALT



**12.340.16**  
16 cm/6¼"



**12.340.20**  
20 cm/8"



**12.341.16**  
16 cm/6¼"



**12.341.20**  
20 cm/8"



LOVELACE  
 16 cm/6¼"



12.354.15



1:2  
 12.356.15

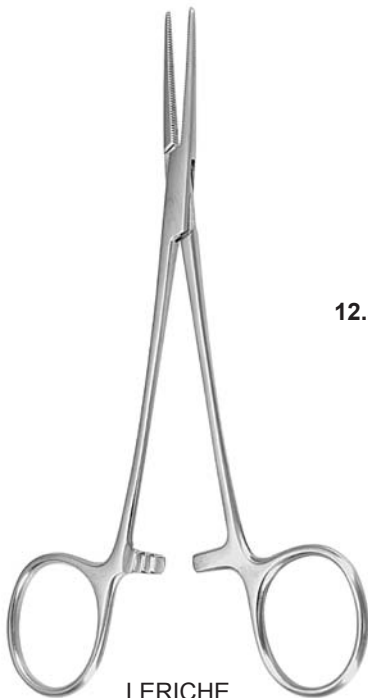

LERICHE  
 15 cm/6"



12.380.15



12.381.15

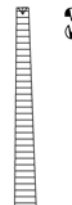

1:2  
 12.382.15



1:2  
 12.383.15





BENGOLEA

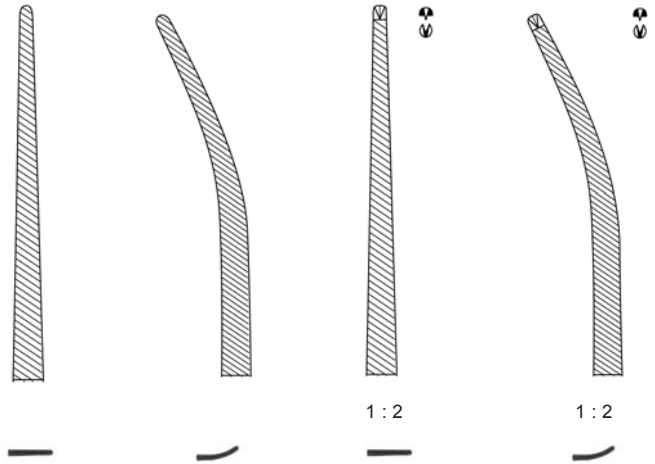

20 cm/8"	<b>12.384.20</b>	<b>12.385.20</b>	<b>12.386.20</b>	<b>12.387.20</b>
26 cm/10¼"	<b>12.384.26</b>	<b>12.385.26</b>	<b>12.386.26</b>	<b>12.387.26</b>



HEISS  
 20 cm/8"

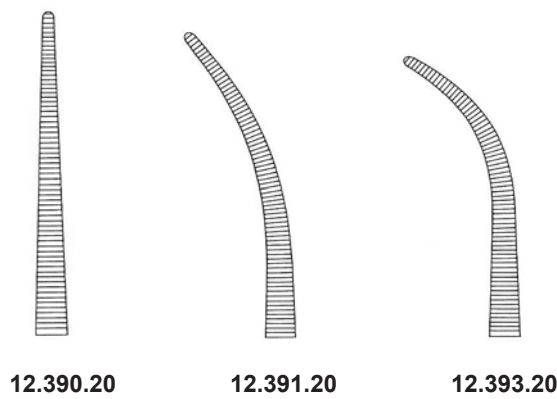

**12.390.20**

**12.391.20**

**12.393.20**



ADSON  
 18,5 cm/7¼"

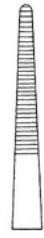

12.410.18



12.411.18



1:2  
 12.412.18



1:2  
 12.413.18



ADSON Baby



12.415.14  
 14 cm/5½"

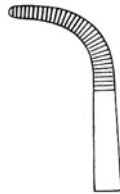

12.415.18  
 18 cm/7"



FUCHSIG  
 12.396.19  
 19 cm/7½"



½



GEMINI



**12.431.13**  
13 cm/5"



**12.431.16**  
16 cm/6¼"

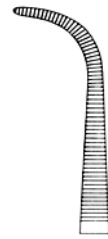

**12.431.18**  
18 cm/7"

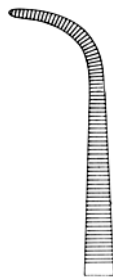

**12.431.20**  
20 cm/8"

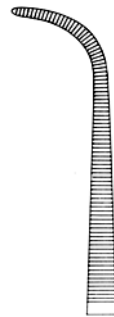

**12.431.23**  
23 cm/9"



**12.431.25**  
25 cm/10"

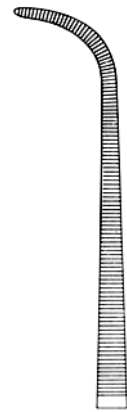

**12.431.28**  
28 cm/11"



GEMINI mini

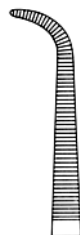

**12.433.18**  
18 cm/7"



**12.433.22**  
22 cm/8¾"



**12.433.25**  
25 cm/10"

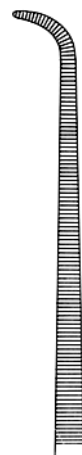

**12.433.28**  
28 cm/11"

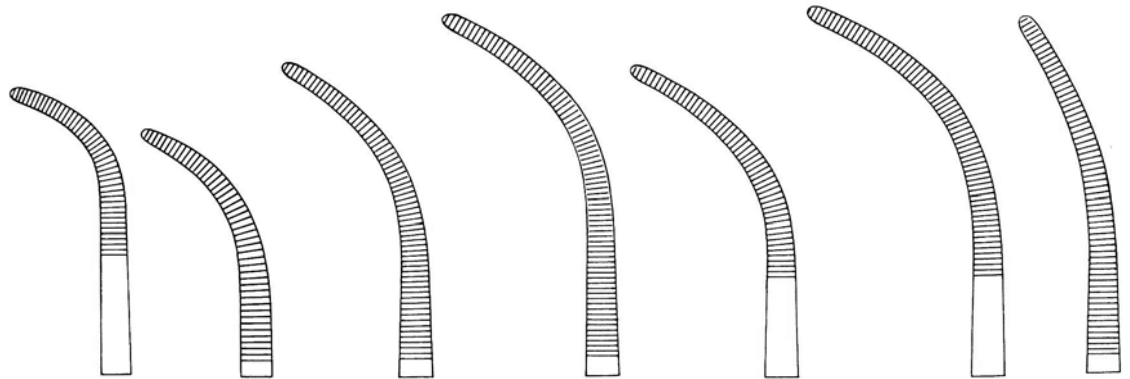

**12.421.01**  
21 cm/8¼"

**12.421.02**  
21 cm/8¼"

**12.421.03**  
21 cm/8¼"

**12.421.04**  
21 cm/8¼"

**12.421.05**  
21 cm/8¼"

**12.421.06**  
21 cm/8¼"

**12.421.07**  
21 cm/8¼"

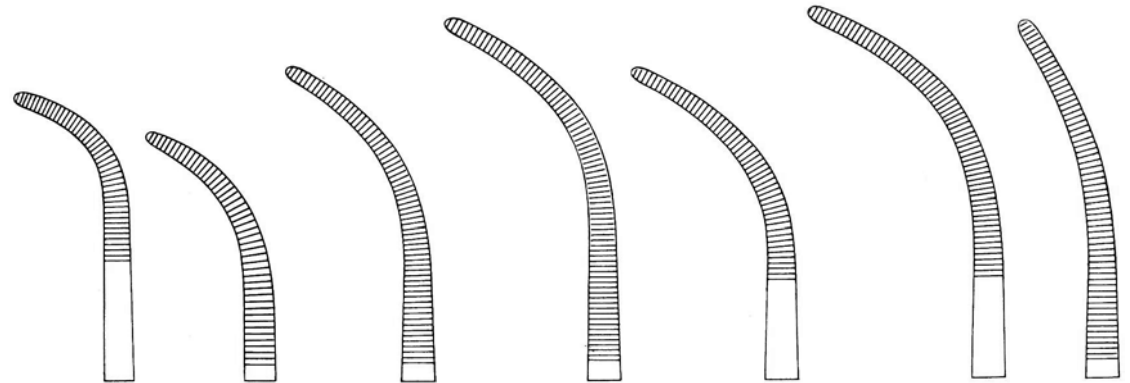

**12.427.01**  
27 cm/10¾"

**12.427.02**  
27 cm/10¾"

**12.427.03**  
27 cm/10¾"

**12.427.04**  
27 cm/10¾"

**12.427.05**  
27 cm/10¾"

**12.427.06**  
27 cm/10¾"

**12.427.07**  
27 cm/10¾"

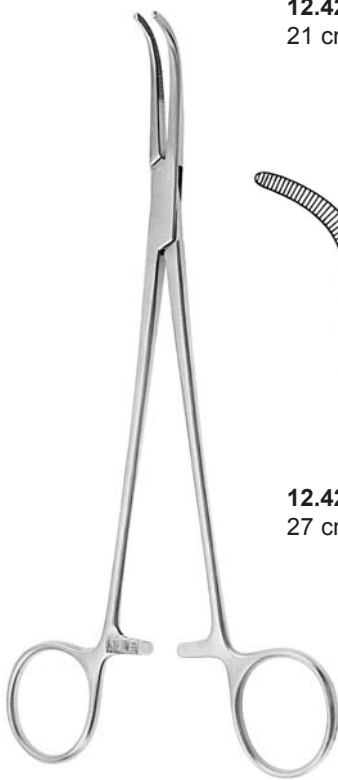

OVERHOLT-GEISSENDOERFER



OVERHOLT-BABY  
**12.284.14**  
 13,5 cm/5¼"



OVERHOLT

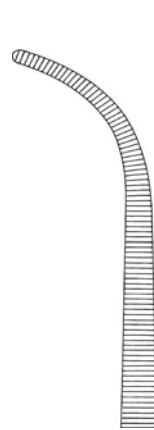

**12.428.00**  
29,5 cm/12"

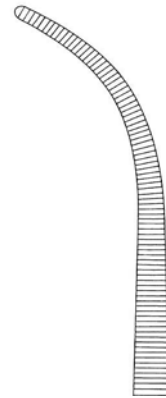

**12.428.01**  
29,5 cm/12"

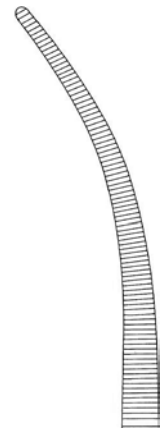

**12.428.06**  
30 cm/12"



OVERHOLT fino

Grazilles Modell  
 Delicate pattern  
 Modèle gracile  
 Modelo delicado  
 Modello delicato

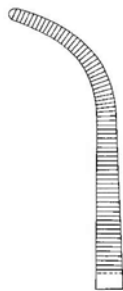

**12.428.10**  
21,5 cm/8½"

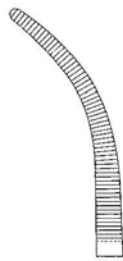

**12.428.11**  
21 cm/8¼"

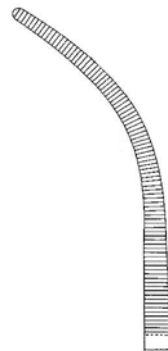

**12.428.12**  
22 cm/8¾"

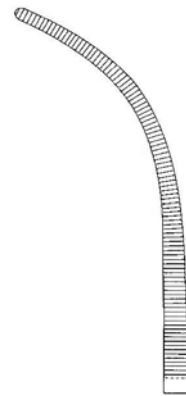

**12.428.13**  
22,5 cm/9"

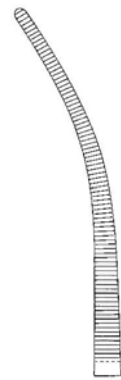

**12.428.16**  
22,5 cm/9"



OVERHOLT

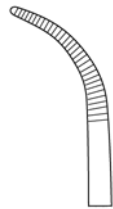

**12.429.01**  
18,5 cm/7¼"

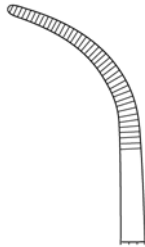

**12.429.02**  
20,5 cm/8"

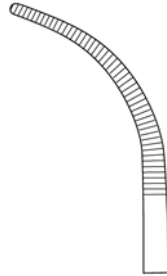

**12.429.03**  
21,0 cm/8¼"

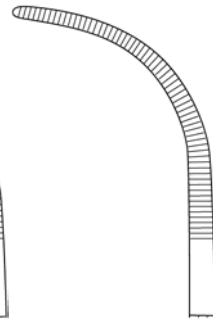

**12.429.04**  
21,5 cm/8½"

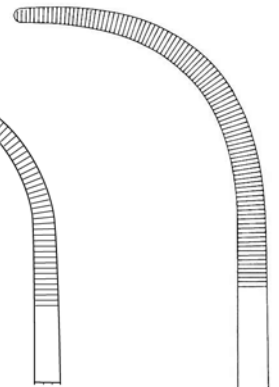

**12.429.05**  
24 cm/9½"

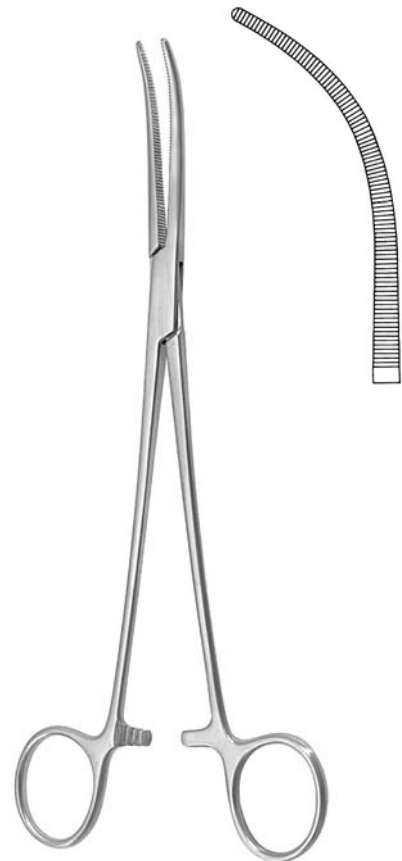

OVERHOLT-MIXTER  
**12.476.21**  
 21 cm/8¼"



RUMMEL  
 23 cm/9"

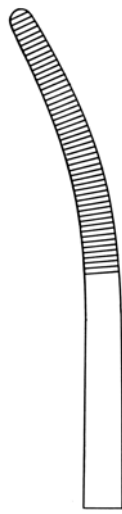

12.441.01

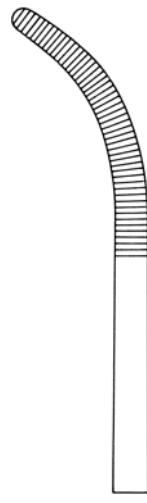

12.441.02

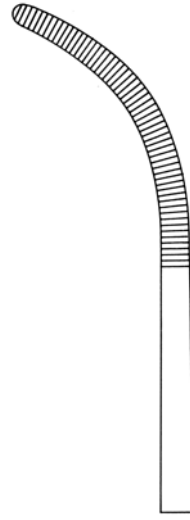

12.441.03

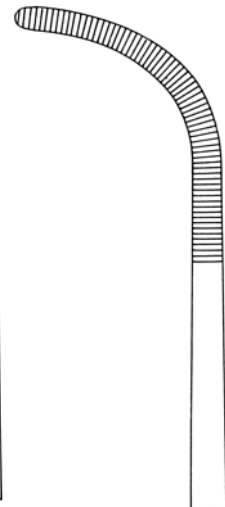

12.441.04



SAROT  
 24 cm/9½"



12.450.24

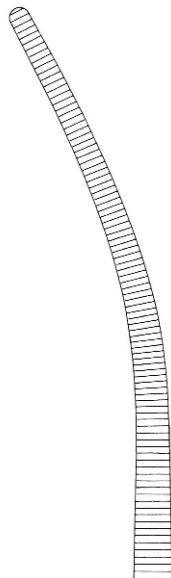

12.451.24

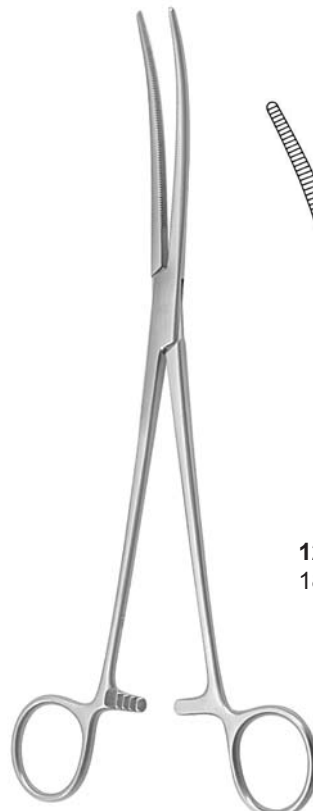

CRAFOORD

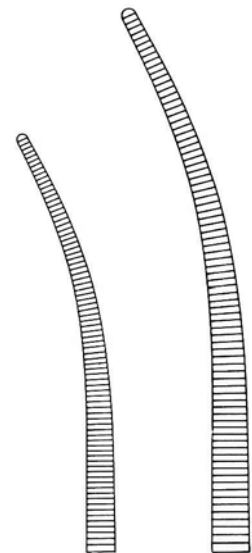

12.453.18  
 18 cm/7"



12.453.24  
 24 cm/9½"

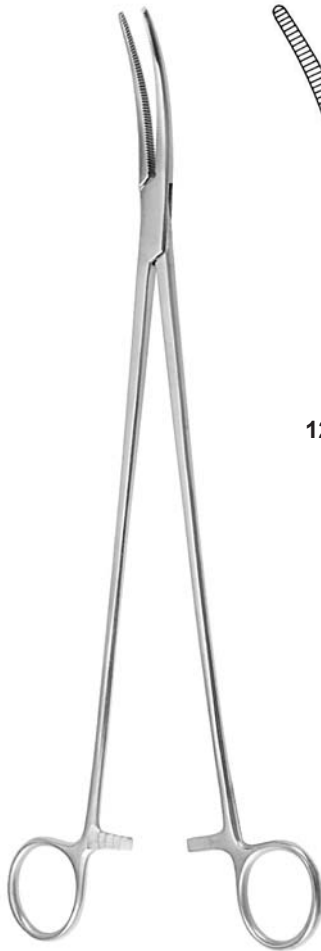

12.455.01

12.455.02

ZENKER  
29,5 cm/12"



LAWRENCE  
12.457.28  
28 cm/11"



12.468.14

12.469.14

Baby MIXTER  
14 cm/5½"





**MIXTER**

14 cm/5½"	<b>12.471.14</b>
16 cm/6¼"	<b>12.471.16</b>
18 cm/7"	<b>12.471.18</b>
23 cm/9"	<b>12.471.23</b>

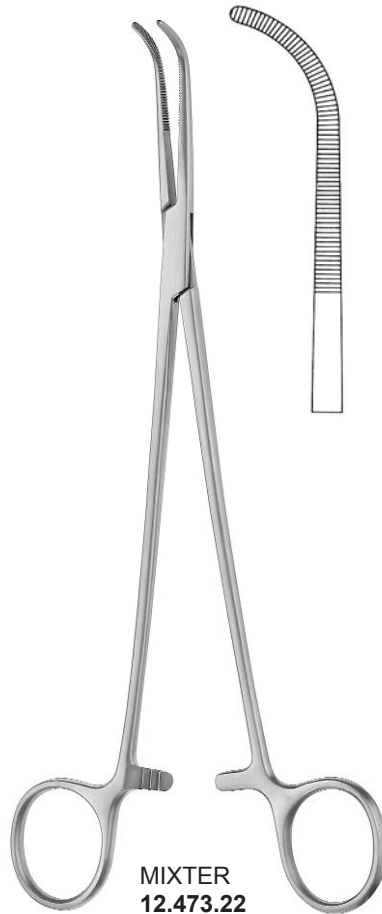

**MIXTER**  
**12.473.22**  
 22 cm/8¾"



**MIXTER**  
**12.473.23**  
 23 cm/9"

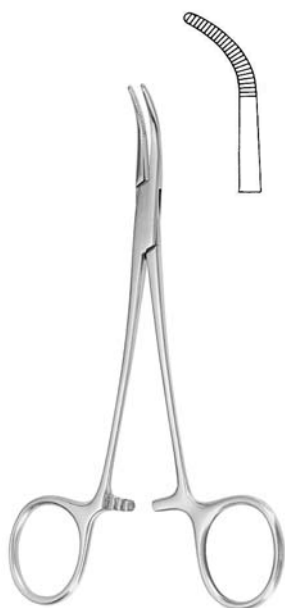

**MIXTER Baby**  
**12.475.14**  
 14 cm/5½"



**MIXTER Baby**  
**12.475.18**  
 18 cm/7"



**MIXTER-O'SHAUGHNESSY**  
 15,5 cm/6" **12.477.15**  
 19,0 cm/7½" **12.477.19**



**MIXTER**

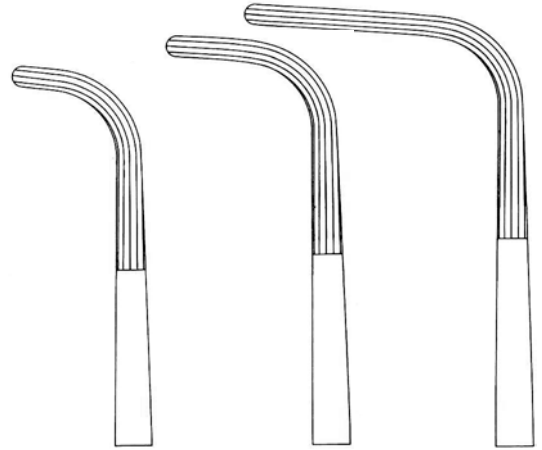

**12.479.22**  
 22 cm/8¾"

**12.479.25**  
 25 cm/9¾"

**12.479.28**  
 28 cm/11"



**WICKSTROEM**

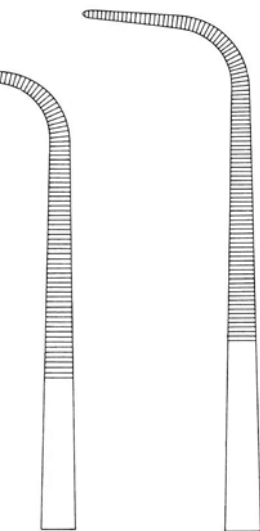

**12.478.21**  
 21 cm/8¼"

**12.478.24**  
 24 cm/9½"



**McQUIGG-MIXTER**  
**12.489.22**  
 22 cm/8¾"

Peritoneumklemmen  
 Peritoneal Clamp Forceps  
 Pincas a peritoneo  
 Pinzas para peritoneo  
 Pinze per peritoneo

*dimeda*<sup>®</sup>

SURGICAL INSTRUMENTS

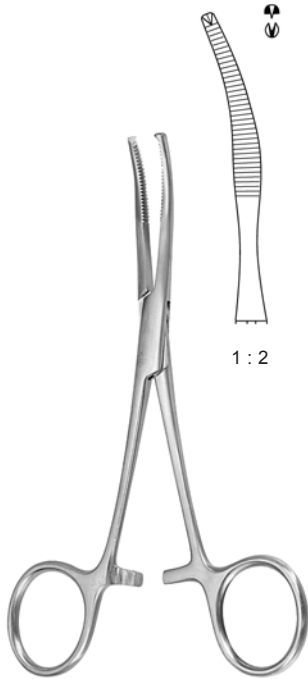

MIKULICZ-Baby  
**12.550.14**  
 14 cm/5½"



MIKULICZ

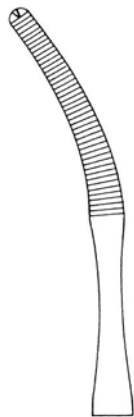

1:2

**12.550.20**  
 20 cm/8"

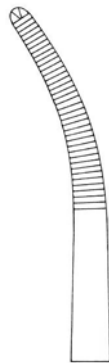

1:2

**12.550.21**  
 20,5 cm/8"



1:2

**12.553.18**  
 18 cm/7"



1:2

**12.553.20**  
 20 cm/8"

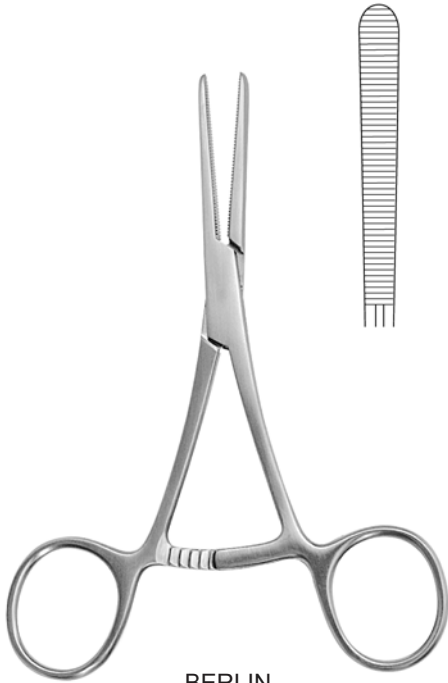

**BERLIN**  
**12.702.14**  
 14,5 cm/5¾"

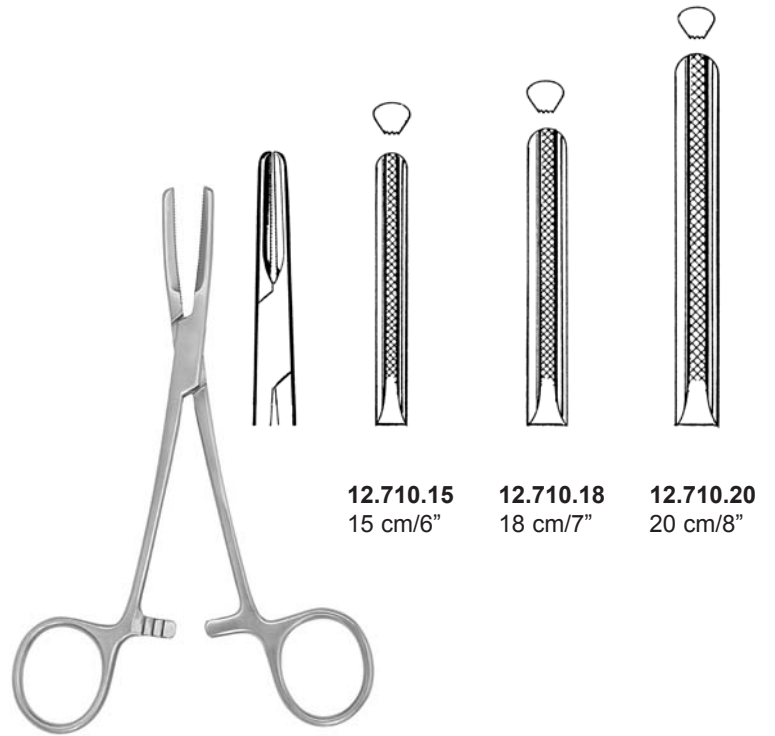

**12.710.15**  
 15 cm/6"

**12.710.18**  
 18 cm/7"

**12.710.20**  
 20 cm/8"

**MURPHY**



**PRESBYTERIAN HOSPITAL**  
 16 cm/6¼" **12.704.16**  
 18 cm/7" **12.704.18**

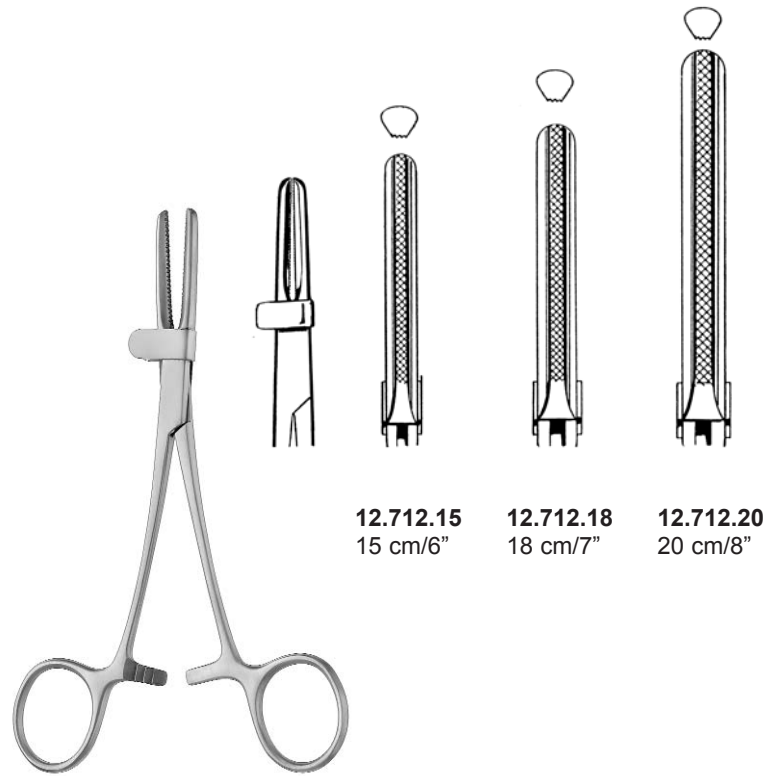

**12.712.15**  
 15 cm/6"

**12.712.18**  
 18 cm/7"

**12.712.20**  
 20 cm/8"

**ATRAUMA**



DE BAKEY

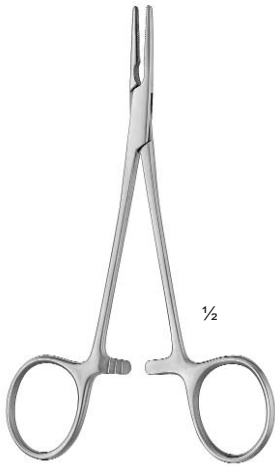

HALSTEAD-MOSQUITO



**13.080.12**  
12 cm/4<sup>3</sup>/<sub>4</sub>"



**13.081.12**  
12 cm/4<sup>3</sup>/<sub>4</sub>"



**13.080.15**  
15 cm/6"



**13.081.15**  
15 cm/6"



**13.082.14**  
14 cm/5<sup>1</sup>/<sub>2</sub>"

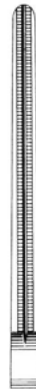

**13.082.16**  
16 cm/6<sup>1</sup>/<sub>4</sub>"



**13.082.18**  
18 cm/7"

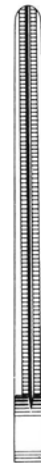

**13.082.20**  
20 cm/8"

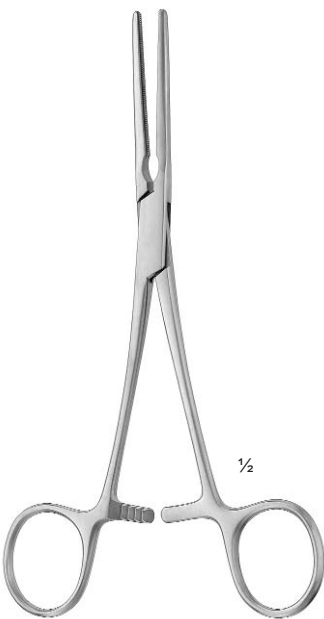

PEAN



**13.083.14**  
14 cm/5<sup>1</sup>/<sub>2</sub>"



**13.083.16**  
16 cm/6<sup>1</sup>/<sub>4</sub>"



**13.083.18**  
18 cm/7"



**13.083.20**  
20 cm/8"

**ATRAUMA**



DE BAKEY

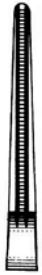

13.084.16



13.085.16

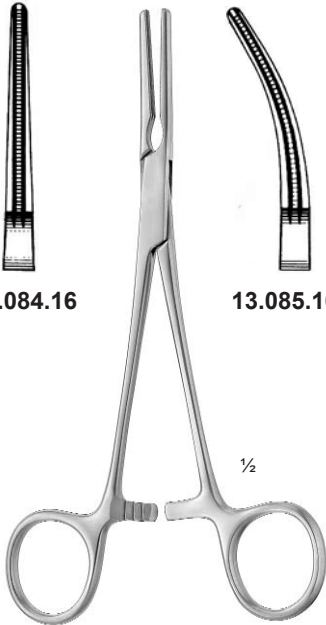

RANKIN  
 16 cm/6 1/4"



13.101.40  
 23 cm/9"



13.101.50  
 23,5 cm/9 1/4"



13.101.60  
 24,5 cm/9 3/4"



HOPT

**ATRAUMA**



DE BAKEY

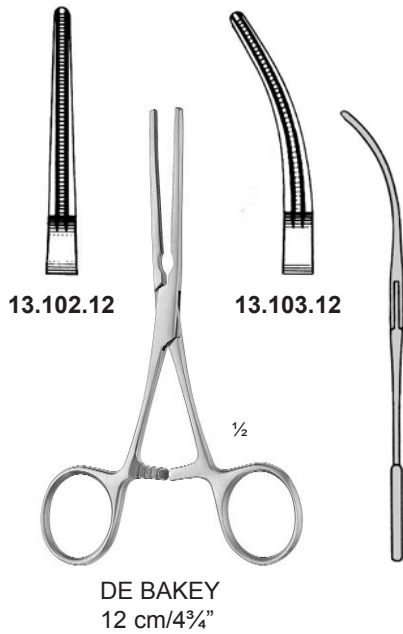

**ATRAUMA**



DE BAKEY



LEES

1/2

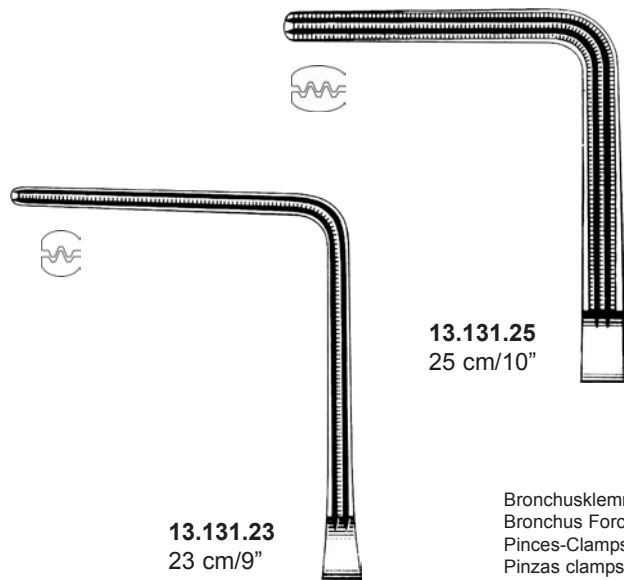

**13.131.23**  
23 cm/9"

**13.131.25**  
25 cm/10"

Bronchusklemmen  
 Bronchus Forceps  
 Pincés-Clamps à Bronches  
 Pinzas clamps bronquiales  
 Pinze per bronchi



LEES  
**13.133.25**  
25 cm/10"

1/2



Coarctationsklemmen  
 Coarction Clamps  
 Pincès à coarctacion  
 Pinzas para coarctación  
 Pinze per coartazione

**ATRAUMA**



DE BAKEY



POTTS



**13.140.20**  
20 cm/8"



**13.140.21**  
21 cm/8 1/4"



**13.140.22**  
22 cm/8 3/4"



**13.140.26**  
26 cm/10 1/4"

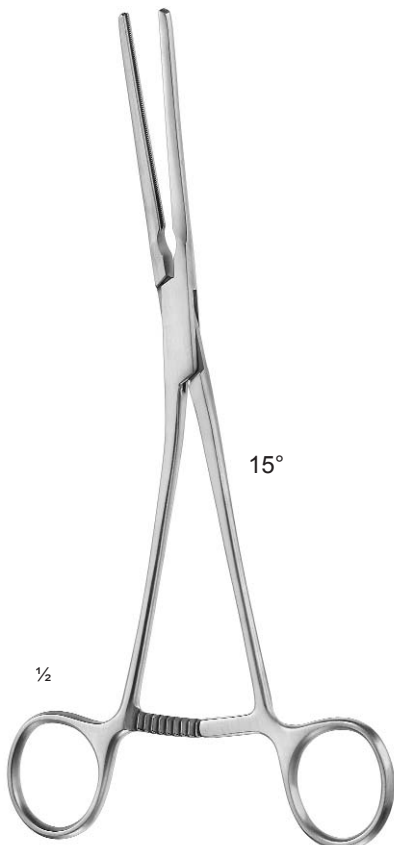

GLOVER



**13.141.20**  
20 cm/8"

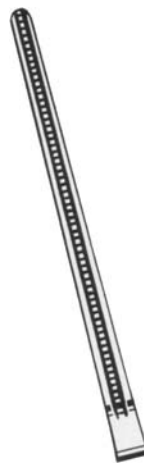

**13.141.22**  
22 cm/8 3/4"

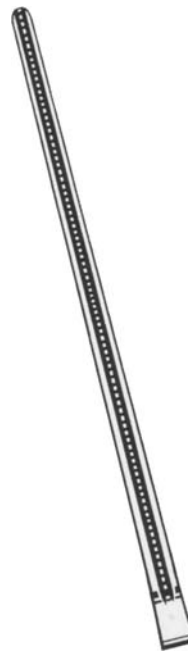

**13.141.26**  
26 cm/10 1/4"

**ATRAUMA**



DE BAKEY



POTTS



**13.142.21**  
21 cm/8<sup>1</sup>/<sub>4</sub>"



**13.142.22**  
22 cm/8<sup>3</sup>/<sub>4</sub>"



Coarctationsklemmen  
 Coarction Clamps  
 Pincas à coarctacion  
 Pinzas para coarctación  
 Pinze per coartazione



POTTS



**13.143.21**  
21 cm/8<sup>1</sup>/<sub>4</sub>"

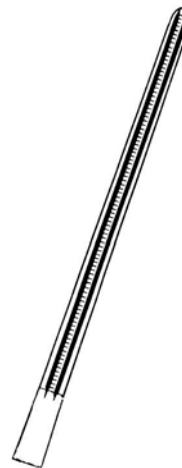

**13.143.22**  
22 cm/8<sup>3</sup>/<sub>4</sub>"

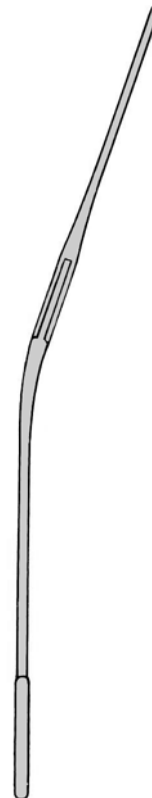

Atraumatische Gefäßklemmen  
 Atraumatic Vascular Clamps  
 Pincés vasculaires atraumatiques  
 Pinzas vasculares atraumáticas  
 Pinze vascolari atraumatiche

**dimed**<sup>®</sup>

SURGICAL INSTRUMENTS

Anastomosenklemmen  
 Anastomosis Clamps  
 Pincés à anastomose  
 Pinzas para anastomosis  
 Pinze per anastomosi

**ATRAUMA**



DE BAKEY



GLOVER

1/2

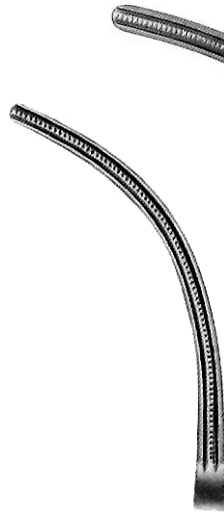

**13.151.21**  
 21 cm/8 1/4"



**13.151.24**  
 24 cm/9 1/2"



GLOVER

1/2



**13.153.18**  
 18 cm/7"

**13.153.22**  
 22 cm/8 3/4"

Atraumatische Gefäßklemmen  
Atraumatic Vascular Clamps  
Pinces vasculaires atraumatiques  
Pinzas vasculares atraumáticas  
Pinze vascolari atraumatiche

**dimeda**<sup>®</sup>

SURGICAL INSTRUMENTS

**ATRAUMA**



DE BAKEY

Anastomosenklemmen  
Anastomosis Clamps  
Pinces à anastomose  
Pinzas para anastomosis  
Pinze per anastomosi



**GLOVER**  
**13.161.21**  
21 cm/8<sup>1</sup>/<sub>4</sub>"



**GLOVER**  
**13.161.26**  
26 cm/10<sup>1</sup>/<sub>4</sub>"

Atraumatische Gefäßklemmen  
 Atraumatic Vascular Clamps  
 Pincés vasculaires atraumatiques  
 Pinzas vasculares atraumáticas  
 Pinze vascolari atraumatiche

**dimed**<sup>®</sup>

SURGICAL INSTRUMENTS

Peripheal-Gefäßklemmen  
 Peripheal Vascular Clamps  
 Pincés-clamps, vasculaires périphériques  
 Pinzas para vasos periféricos  
 Pinze vascolari periferali

**ATRAUMA**



DE BAKEY

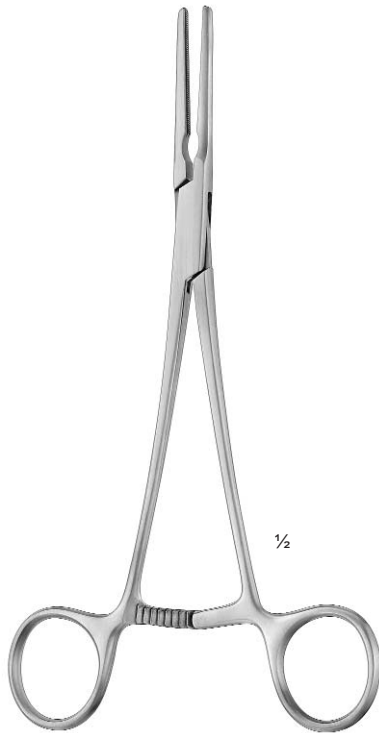

DE BAKEY

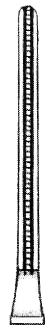

**13.170.19**  
19 cm/7½"



**13.170.22**  
22 cm/8¾"

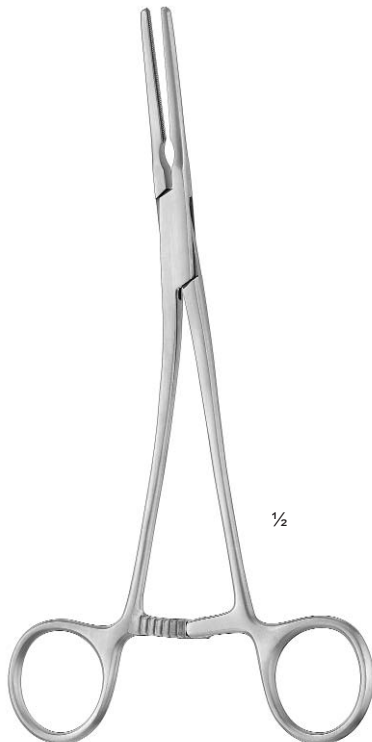

DE BAKEY



**13.171.19**  
19 cm/7½"

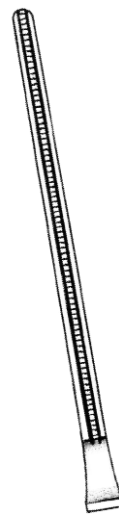

**13.171.22**  
22 cm/8¾"

**ATRAUMA**



DE BAKEY

Atraumatische Mehrzweckklemmen  
 Atraumatic Multi-Purpose Clamps  
 Pincès-clamps polyvalentes  
 Pinzas clamps para usos varios  
 Pinze atraumatiche per diversi usi

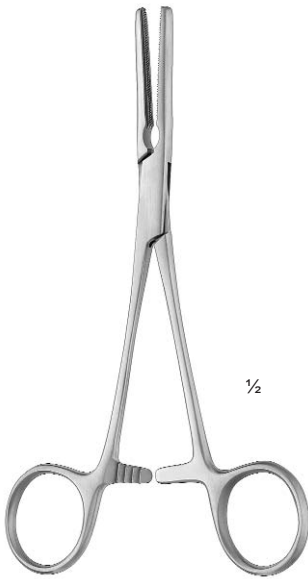

1/2

DARDIK



0°

**13.172.00**  
15 cm/6"



15°

**13.172.15**  
15 cm/6"



30°

**13.172.30**  
15 cm/6"



45°

**13.172.45**  
15 cm/6"



90°

**13.172.90**  
14 cm/5½"

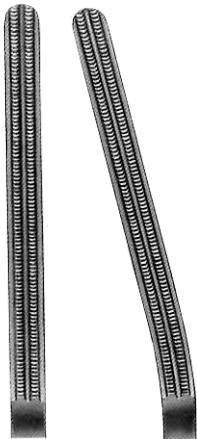

0°

**13.174.00**  
16 cm/6¼"

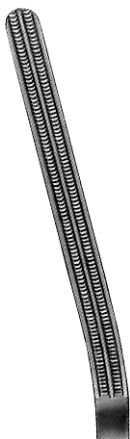

15°

**13.174.15**  
16 cm/6¼"

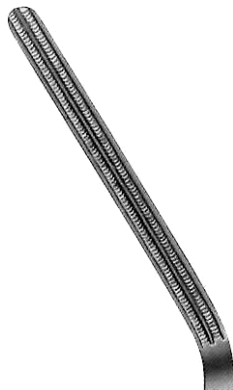

30°

**13.174.30**  
16 cm/6¼"



45°

**13.174.45**  
16 cm/6¼"



90°

**13.174.90**  
17 cm/6¾"

Atraumatische Gefäßklemmen  
 Atraumatic Vascular Clamps  
 Pincès vasculaires atraumatiques  
 Pinzas vasculares atraumáticas  
 Pinze vascolari atraumatiche

**dimeda**<sup>®</sup>

SURGICAL INSTRUMENTS

Peripheal-Gefäßklemmen  
 Peripheal Vascular Clamps  
 Pincès-clamps, vasculaires périphériques  
 Pinzas para vasos periféricos  
 Pinze vascolari periferali

**ATRAUMA**



DE BAKEY



LELAND-JONES  
**13.181.19**  
 19 cm/7½"



DE BAKEY  
**13.181.26**  
 19 cm/7½"

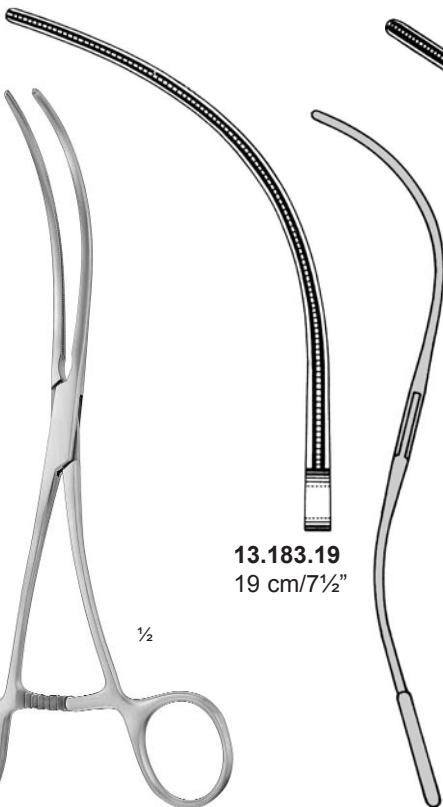

DE BAKEY

**13.183.19**  
 19 cm/7½"

**13.183.20**  
 20 cm/8"

**13.191.16**  
 16 cm/6¼"

**ATRAUMA**



DE BAKEY

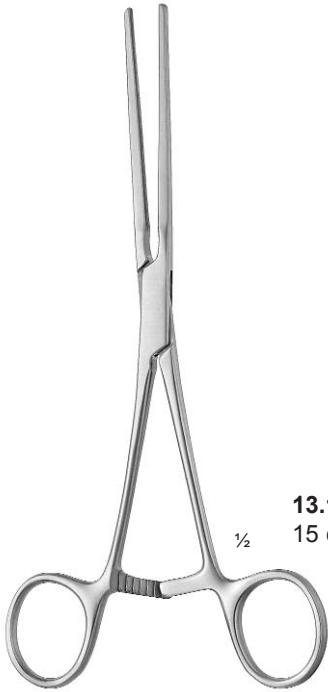

BAINBRIDGE

½

**13.196.15**  
15 cm/6"

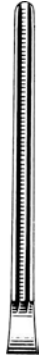

**13.196.18**  
18 cm/7"



**13.197.15**  
15 cm/6"



**13.197.18**  
18 cm/7"



Atraumatische Mehrzweckklemmen  
 Atraumatic Multi-Purpose Clamps  
 Pincas-clamps polyvalentes  
 Pinzas clamps para usos varios  
 Pinze atraumatiche per diversi usi



LELAND-JONES

½

**13.202.19**  
19 cm/7½"

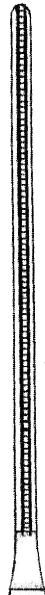

**13.203.19**  
19 cm/7½"



**13.205.19**  
19 cm/7½"





Atraumatische Gefäßklemmen  
 Atraumatic Vascular Clamps  
 Pincés vasculaires atraumatiques  
 Pinzas vasculares atraumáticas  
 Pinze vascolari atraumatiche

**dimed**<sup>®</sup>

SURGICAL INSTRUMENTS

Aortaklemmen  
 Aortic Clamp  
 Pince-clamp à aorte  
 Pinza clamp para aorta  
 Pinza per aorta

**ATRAUMA**



DE BAKEY

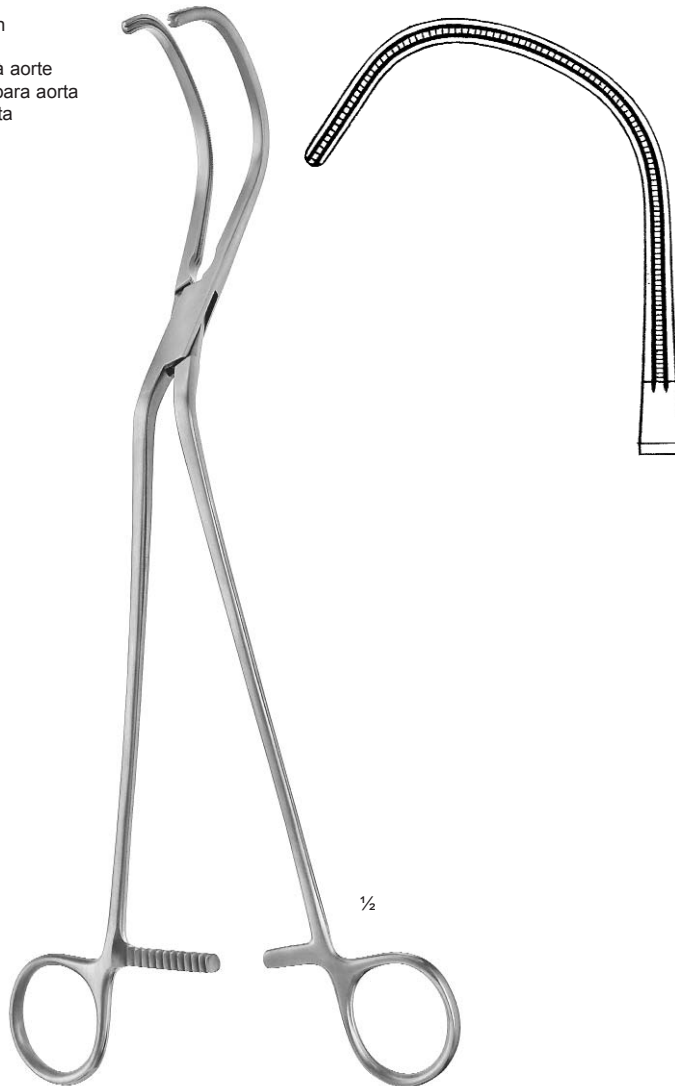

LIDDLE  
**13.209.27**  
 27 cm/10½"

Aorta-Anastomosenklemmen  
 Aorta-Anastomosis Clamps  
 Pincés-clamps pour anastomoses d'aorte  
 Pinzas clamps para anastomosis de aorta  
 Pinze aortiche

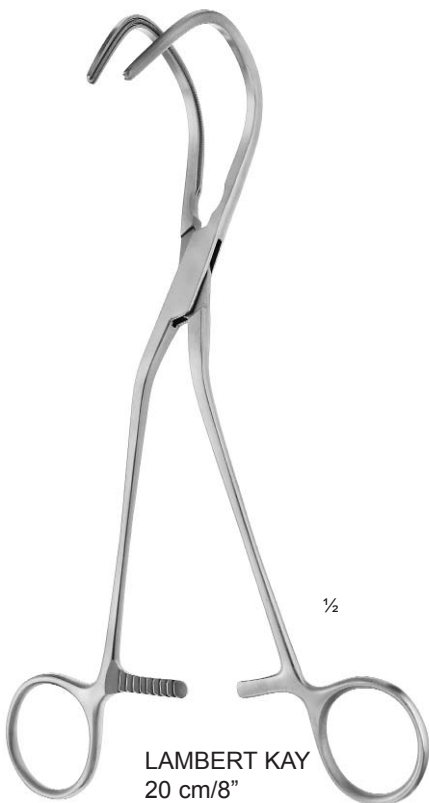

LAMBERT KAY  
 20 cm/8"

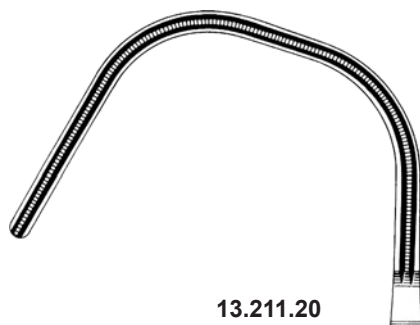

**13.211.20**



**13.213.20**

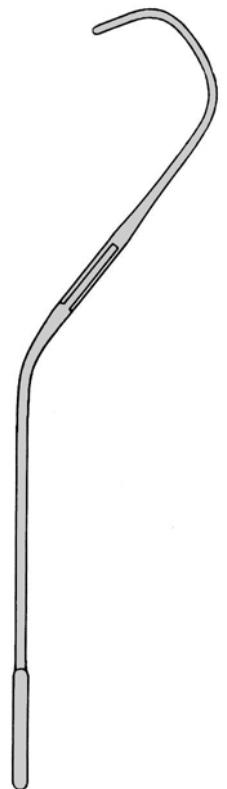

Atraumatische Gefäßklemmen  
Atraumatic Vascular Clamps  
Pinces vasculaires atraumatiques  
Pinzas vasculares atraumáticas  
Pinze vascolari atraumatiche

**dimeda**<sup>®</sup>

SURGICAL INSTRUMENTS

**ATRAUMA**



DE BAKEY

Iliaca-Klemme  
Iliac Clamp  
Pince-clamp à iliaque  
Pinza clamp para iliaca  
Pinza per iliaca

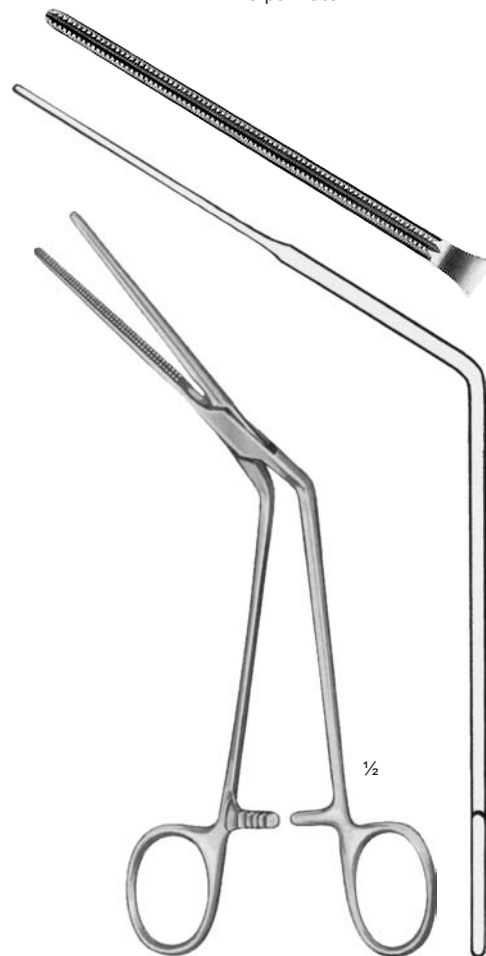

DE BAKEY  
**13.215.20**  
20 cm/8"



links gebogen  
 curved to left  
 courbe à gauche  
 curva a la izquierda  
 curva a sinistra



rechts gebogen  
 curved to right  
 courbe à droite  
 curva a la derecha  
 curva a destra

Aortaklemmen  
 Aortic Clamp  
 Pince-clamp à aorte  
 Pinza clamp para aorta  
 Pinza per aorta



WEBER  
**13.217.26**  
 26 cm/10<sup>1</sup>/<sub>4</sub>"



WEBER  
**13.219.26**  
 26 cm/10<sup>1</sup>/<sub>4</sub>"

Atraumatische Gefäßklemmen  
 Atraumatic Vascular Clamps  
 Pincés vasculaires atraumatiques  
 Pinzas vasculares atraumáticas  
 Pinze vascolari atraumatiche

**dimed**<sup>®</sup>

SURGICAL INSTRUMENTS

**ATRAUMA**



DE BAKEY

Aorta-Aneurysma-Klemmen  
 Aorta-Aneurysm Clamps  
 Pincés-clamps pour aneurysme d'aorte  
 Pinzas clamps para aneurisma de aorta  
 Pinze per aneurisma di aorta

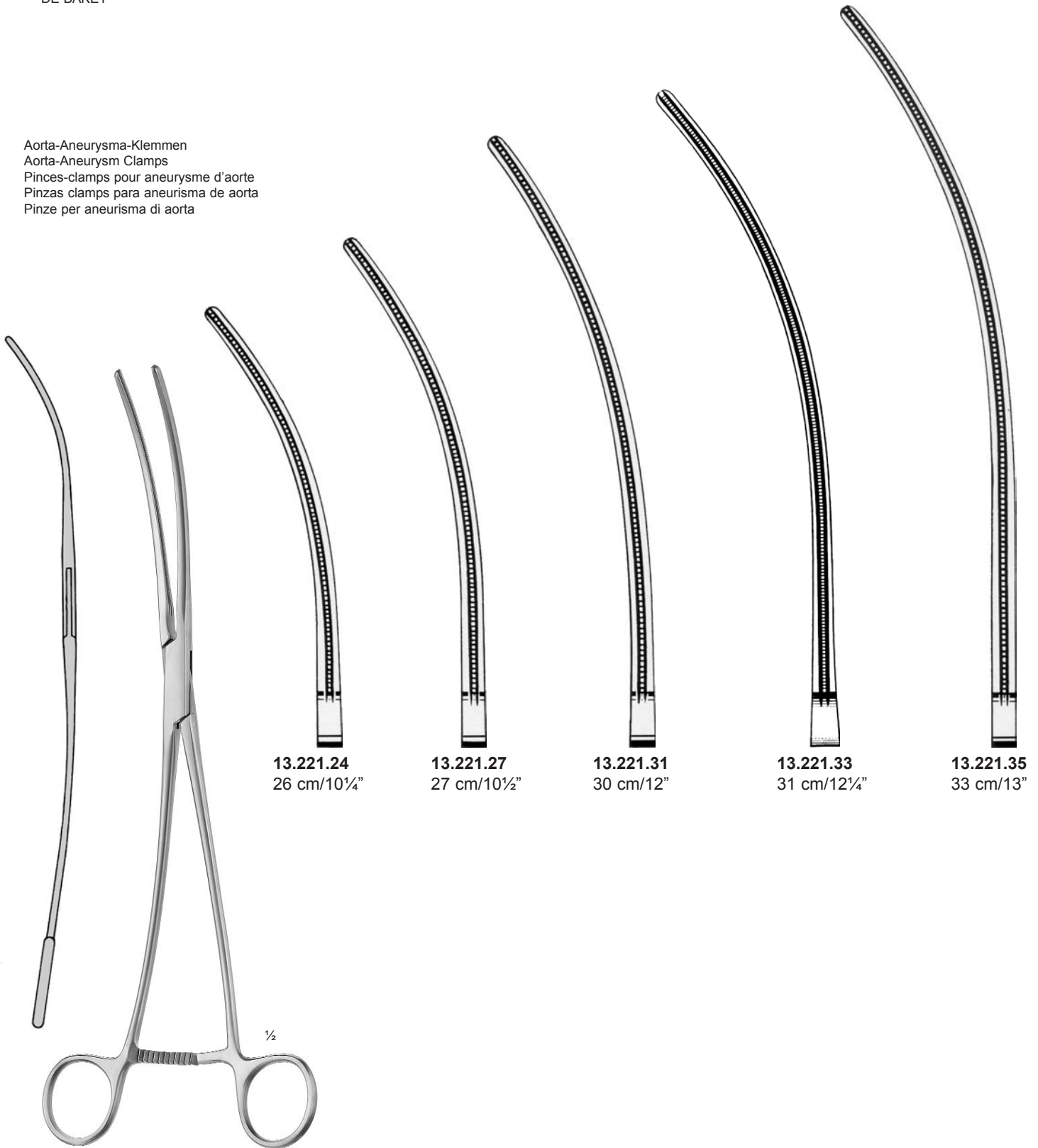

**13.221.24**  
 26 cm/10¼"

**13.221.27**  
 27 cm/10½"

**13.221.31**  
 30 cm/12"

**13.221.33**  
 31 cm/12¼"

**13.221.35**  
 33 cm/13"

DE BAKEY

Atraumatische Gefäßklemmen  
Atraumatic Vascular Clamps  
Pinces vasculaires atraumatiques  
Pinzas vasculares atraumáticas  
Pinze vascolari atraumatiche

**dimed**<sup>®</sup>

SURGICAL INSTRUMENTS

**ATRAUMA**



DE BAKEY

Aorta-Aneurysma-Klemmen  
Aorta-Aneurysm Clamps  
Pinces-clamps pour aneurysme d'aorte  
Pinzas clamps para aneurisma de aorta  
Pinze per aneurisma di aorta

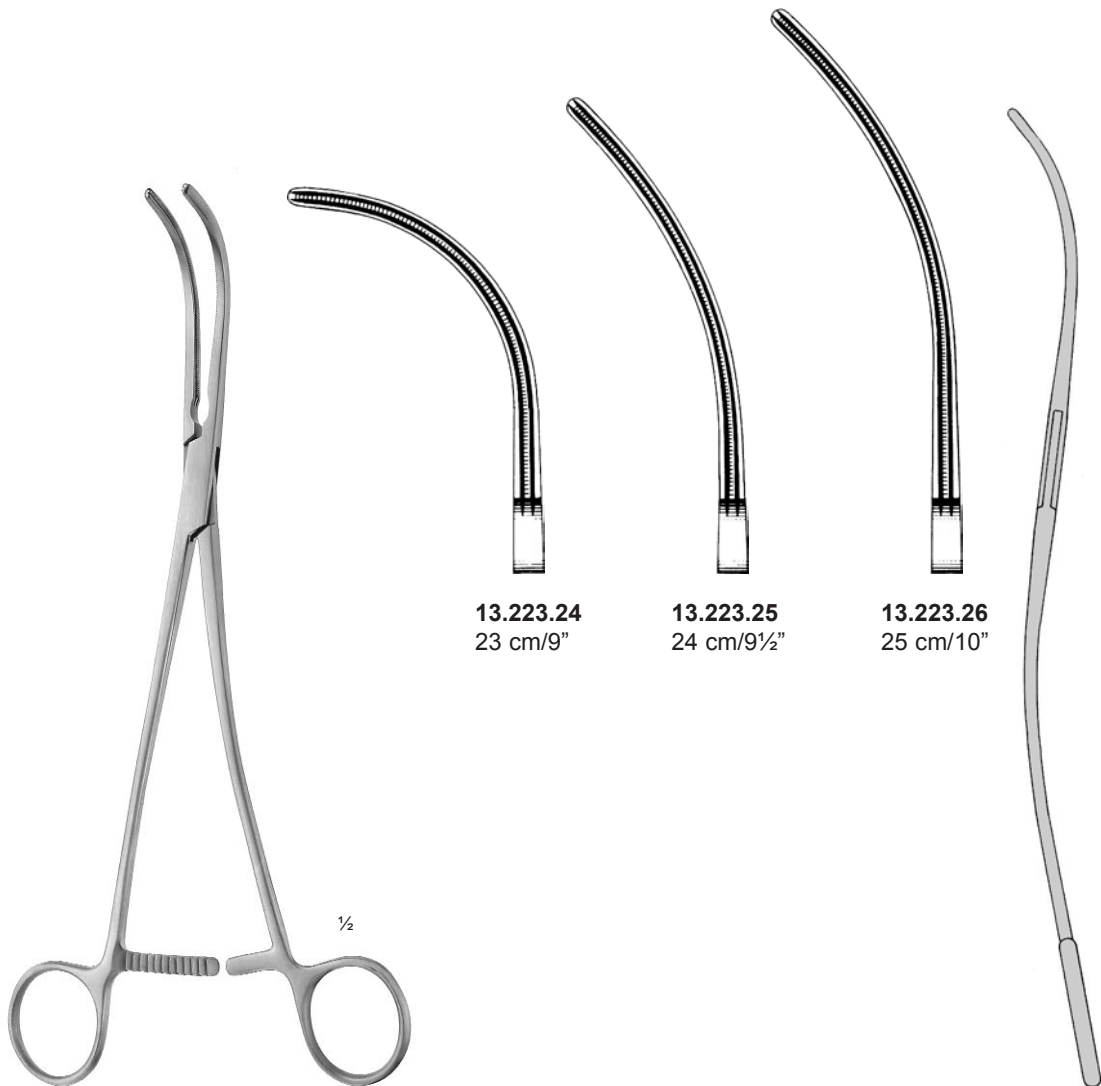

**13.223.24**  
23 cm/9"

**13.223.25**  
24 cm/9½"

**13.223.26**  
25 cm/10"

DE BAKEY-BAHNSON

Atraumatische Gefäßklemmen  
Atraumatic Vascular Clamps  
Pinces vasculaires atraumatiques  
Pinzas vasculares atraumáticas  
Pinze vascolari atraumatiche

**dimeda**<sup>®</sup>

SURGICAL INSTRUMENTS

**ATRAUMA**



DE BAKEY

Aorta-Aneurysma-Klemmen  
Aorta-Aneurysm Clamps  
Pinces-clamps pour aneurysme d'aorte  
Pinzas clamps para aneurisma de aorta  
Pinze per aneurisma di aorta



DE BAKEY  
**13.225.28**  
28 cm/11"

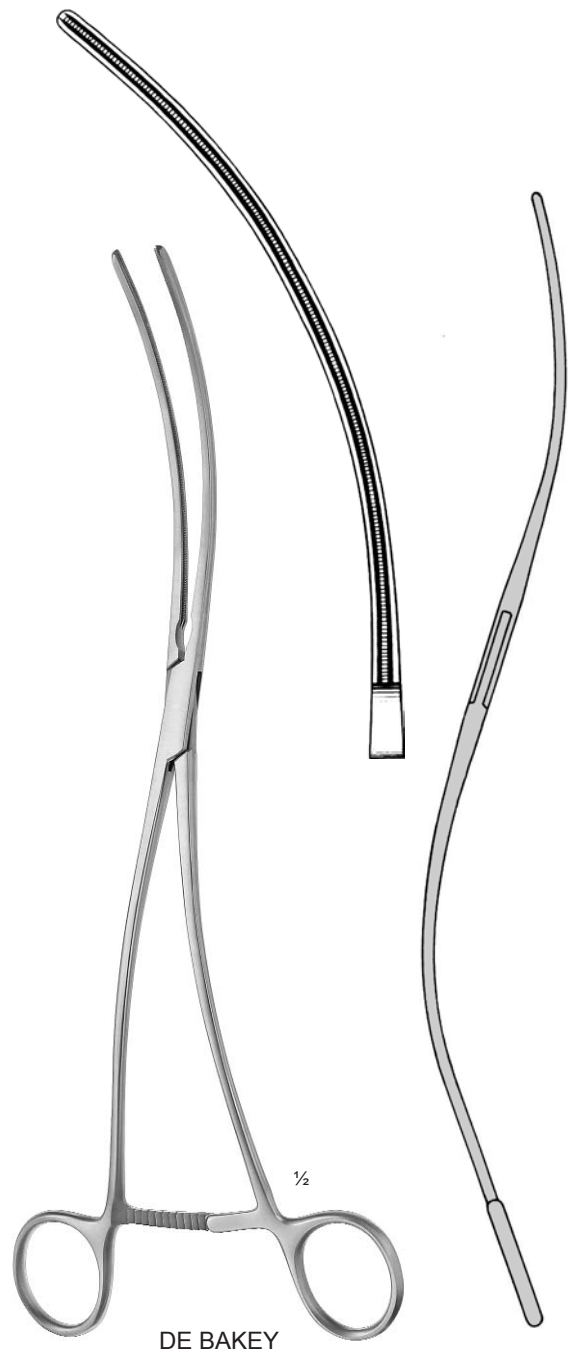

DE BAKEY  
**13.227.28**  
30 cm/12"

Atraumatische Gefäßklemmen  
Atraumatic Vascular Clamps  
Pinces vasculaires atraumatiques  
Pinzas vasculares atraumáticas  
Pinze vascolari atraumatiche

**dimedda**<sup>®</sup>

SURGICAL INSTRUMENTS

Aorta-Aneurysma-Klemmen  
Aorta-Aneurysm Clamps  
Pinces-clamps pour aneurysme d'aorte  
Pinzas clamps para aneurisma de aorta  
Pinze per aneurisma di aorta

**ATRAUMA**



DE BAKEY

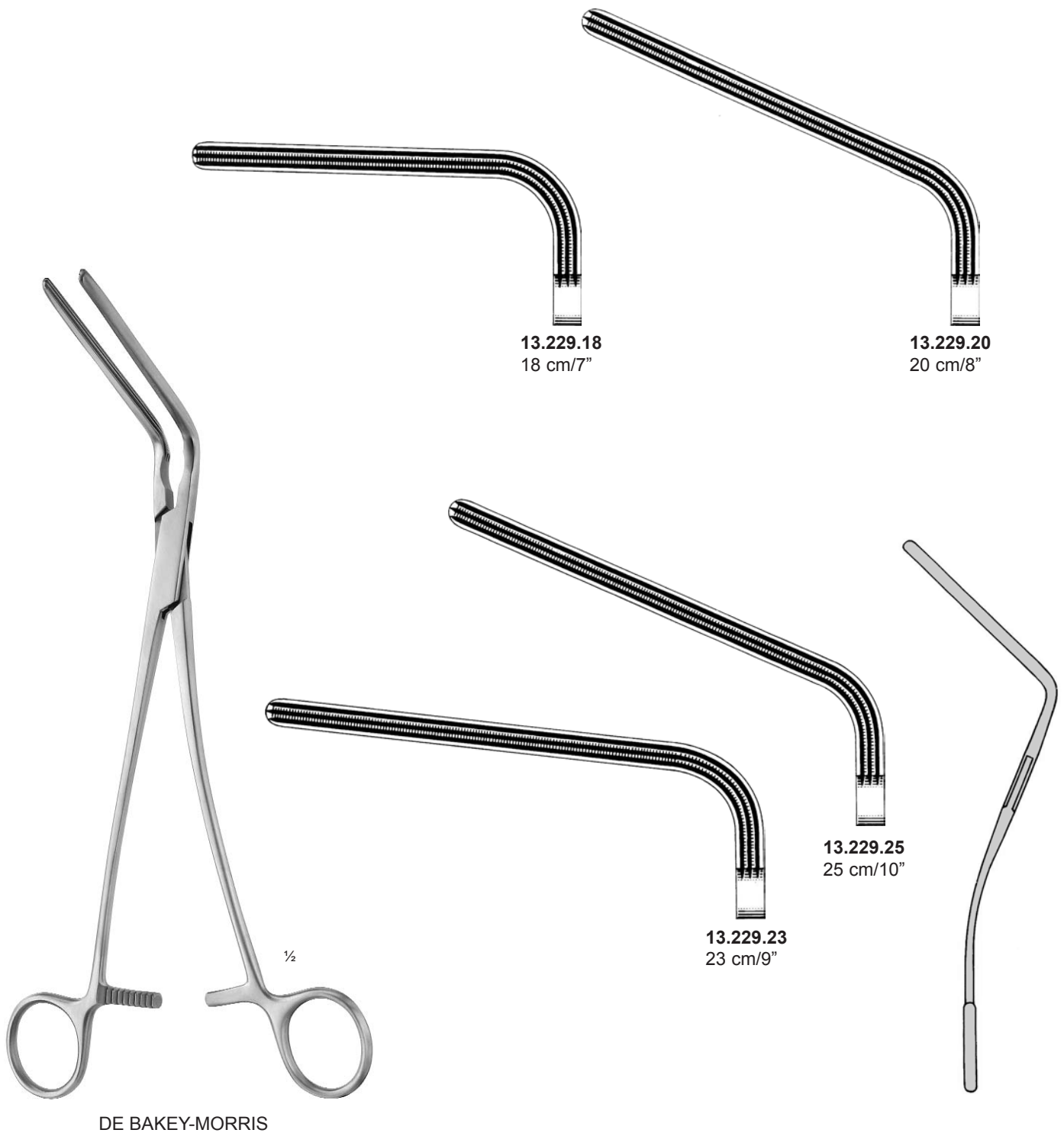

Atraumatische Gefäßklemmen  
 Atraumatic Vascular Clamps  
 Pincés vasculaires atraumatiques  
 Pinzas vasculares atraumáticas  
 Pinze vascolari atraumatiche

**dimedda**<sup>®</sup>

SURGICAL INSTRUMENTS

**ATRAUMA**



DE BAKEY

Atraumatische Mehrzweckklemmen  
 Atraumatic Multi-Purpose Clamps  
 Pincés-clamps polyvalentes  
 Pinzas clamps para usos varios  
 Pinze atraumatiche per diversi usi

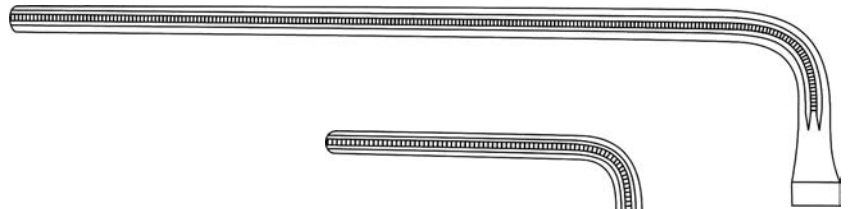

**13.231.27**  
 28 cm/11"

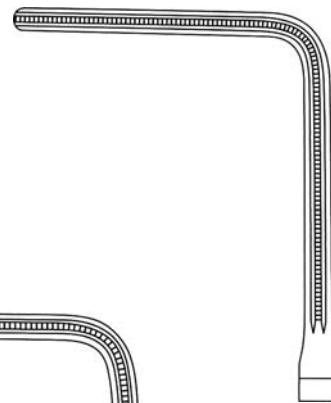

**13.231.23**  
 22 cm/8<sup>3</sup>/<sub>4</sub>"

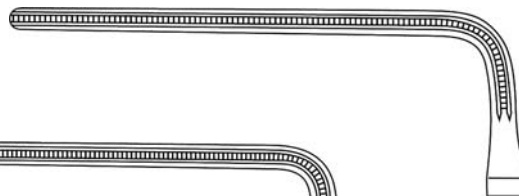

**13.231.21**  
 20 cm/8"

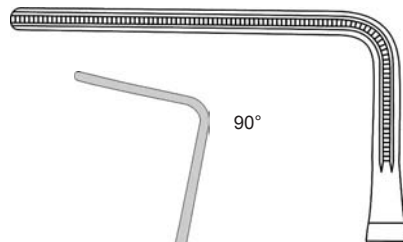

**13.231.18**  
 19 cm/7<sup>1</sup>/<sub>2</sub>"

90°



1/2

DE BAKEY



Atraumatische Gefäßklemmen  
Atraumatic Vascular Clamps  
Pinces vasculaires atraumatiques  
Pinzas vasculares atraumáticas  
Pinze vascolari atraumatiche

**dimed**<sup>®</sup>

SURGICAL INSTRUMENTS

Aorta-Aneurysma-Klemmen  
Aorta-Aneurysm Clamps  
Pinces-clamps pour aneurysme d'aorte  
Pinzas clamps para aneurisma de aorta  
Pinze per aneurisma di aorta

**ATRAUMA**



DE BAKEY

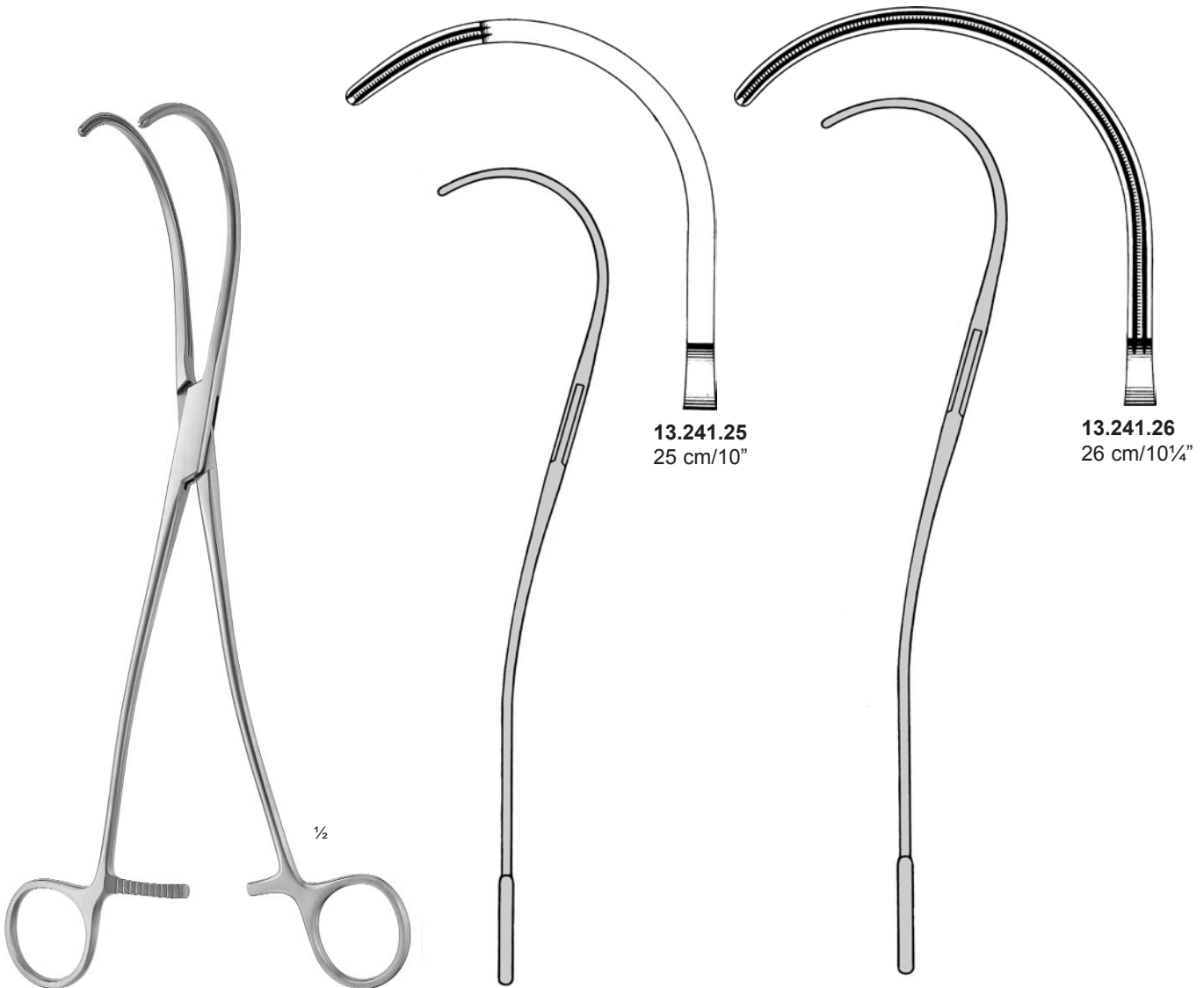

DE BAKEY

Atraumatische Gefäßklemmen  
Atraumatic Vascular Clamps  
Pinces vasculaires atraumatiques  
Pinzas vasculares atraumáticas  
Pinze vascolari atraumatiche

**dimeda**<sup>®</sup>

SURGICAL INSTRUMENTS

**ATRAUMA**



DE BAKEY

Aorta-Aneurysma-Klemmen  
Aorta-Aneurysm Clamps  
Pinces-clamps pour aneurysme d'aorte  
Pinzas clamps para aneurisma de aorta  
Pinze per aneurisma di aorta



DE BAKEY  
13.247.27  
27 cm/10½"

Atraumatische Gefäßklemmen  
 Atraumatic Vascular Clamps  
 Pincés vasculaires atraumatiques  
 Pinzas vasculares atraumáticas  
 Pinze vascolari atraumatiche

**dimed**<sup>®</sup>

SURGICAL INSTRUMENTS

Atraumatische Mehrzweckklemmen  
 Atraumatic Multi-Purpose Clamps  
 Pincés-clamps polyvalentes  
 Pinzas clamps para usos varios  
 Pinze atraumatiche per diversi usi

**ATRAUMA**



DE BAKEY



**13.251.20**  
23 cm/9"

**13.251.24**  
26 cm/10¼"

**13.251.25**  
24 cm/9½"

**13.251.30**  
30 cm/12"



DE BAKEY

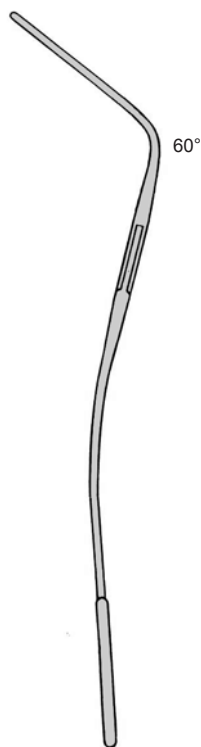

Atraumatische Gefäßklemmen  
 Atraumatic Vascular Clamps  
 Pincés vasculaires atraumatiques  
 Pinzas vasculares atraumáticas  
 Pinze vascolari atraumatiche

**dimedada**<sup>®</sup>

SURGICAL INSTRUMENTS

**ATRAUMA**



DE BAKEY

Tangentialklemmen  
 Tangential Occlusion Clamps  
 Pincés-clamps pour occlusion tangentielle  
 Pinzas para oclusión tangencial  
 Pinze per occlusione tangenziale

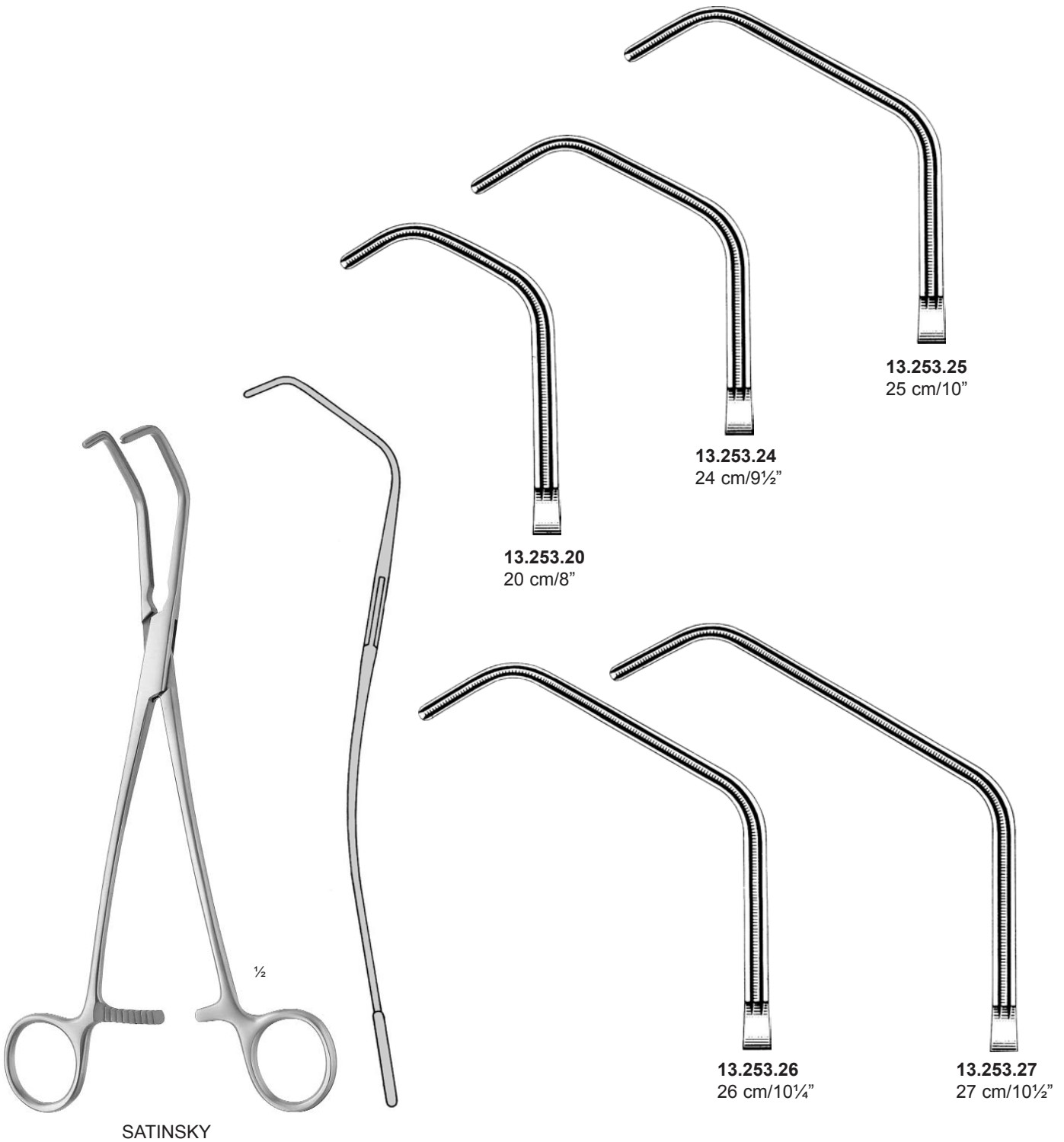

Anlegezange für Clips, Clips  
 Applying forceps for Clips, Clips  
 Appicateur pour clips, Clips  
 Pinza para aplicar clips, Clips  
 Applicatore per clips, Clips

*dimed*<sup>®</sup>

SURGICAL INSTRUMENTS

Anlegezange für Clips  
 Applying forceps for Clips  
 Appicateur pour clips  
 Pinza para aplicar clips  
 Applicatore per clips

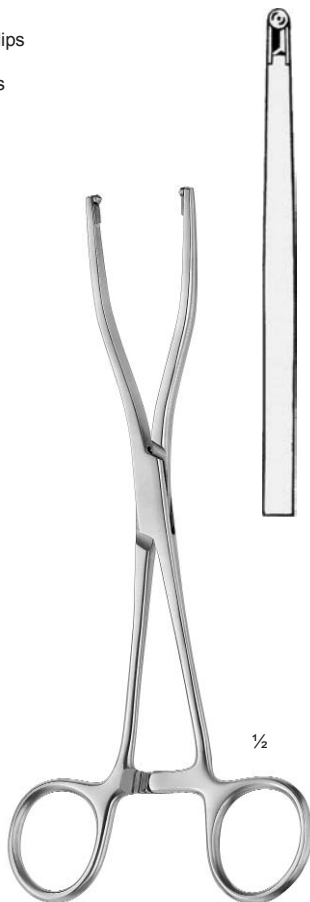

EDWARDS  
**13.258.00**  
 18,5 cm/7¼"

Clips  
 Clips  
 Clips  
 Clips  
 Clips



EDWARDS  
 6 mm **13.258.06**  
 12 mm **13.258.12**

**ATRAUMA**



DE BAKEY



WYLIE

1/2

1/2

1/2

1/2

1/2

1/2

1/2

1/2

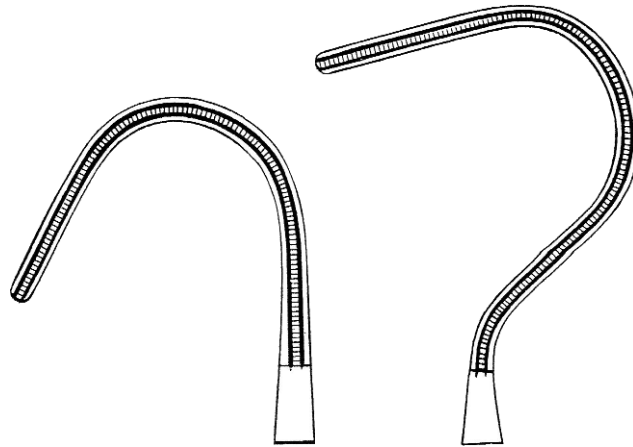

**13.259.01**  
21 cm/8 1/4"

**13.259.02**  
22 cm/8 3/4"

Tangentialklemmen  
 Tangential Occlusion Clamps  
 Pincès-clamps pour occlusion tangentielle  
 Pinzas para oclusión tangencial  
 Pinze per occlusione tangenziale



**13.261.23**  
23 cm/9"

**13.261.24**  
24 cm/9 1/2"

**13.261.25**  
25 cm/10"



DE BAKEY-SATINSKY

Atraumatische Gefäßklemmen  
 Atraumatic Vascular Clamps  
 Pinces vasculaires atraumatiques  
 Pinzas vasculares atraumáticas  
 Pinze vascolari atraumatiche

**dimed**<sup>®</sup>

SURGICAL INSTRUMENTS

**ATRAUMA**



DE BAKEY



13.263.25



13.265.24



Aurikelklemmen  
 Auricle Clamps  
 Pinces auriculaires  
 Pinzas para auricula  
 Pinze ventricolari

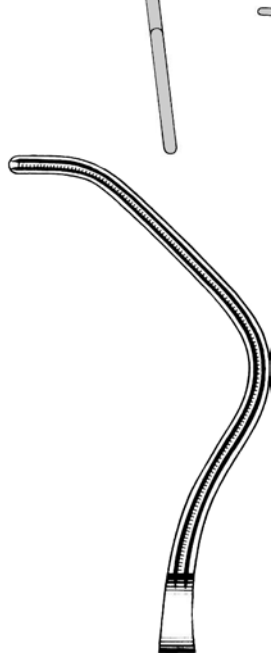

13.267.24

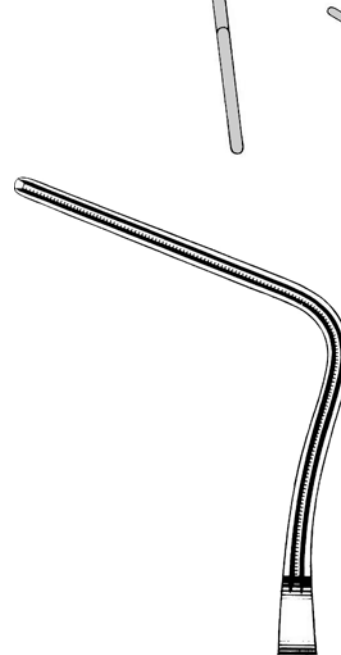

13.269.24

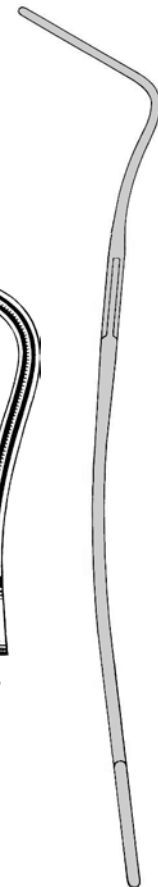

HARKEN  
 24 cm/9½"

½

Atraumatische Gefäßklemmen  
 Atraumatic Vascular Clamps  
 Pincés vasculaires atraumatiques  
 Pinzas vasculares atraumáticas  
 Pinze vascolari atraumatiche

**dimeda**<sup>®</sup>

SURGICAL INSTRUMENTS

**ATRAUMA**



DE BAKEY

Organfaßzange  
 Organ grasping forceps  
 Pincés pour saisir des organes  
 Pinzas para sacar órganos  
 Pinze per afferrare organi



**13.270.25**  
 25 cm/10"



**13.270.26**  
 26 cm/10¼"

Peripheal-Gefäßklemmen  
 Peripheal Vascular Clamps  
 Pincés-clamps, vasculaires périphériques  
 Pinzas para vasos periféricos  
 Pinze vascolari periferali

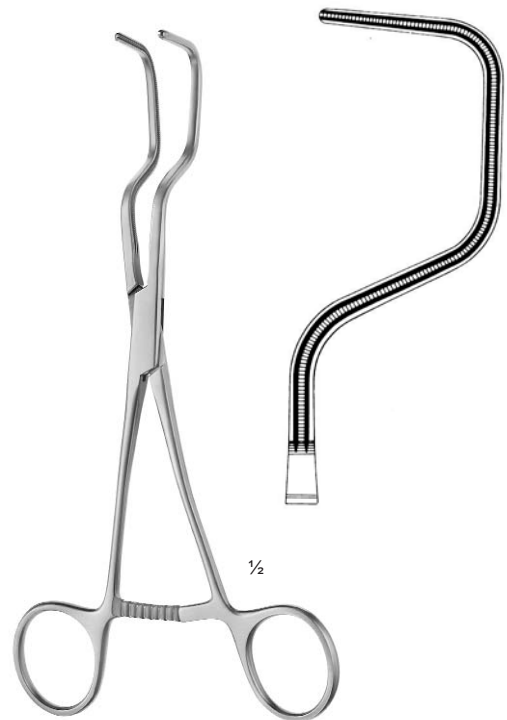

DALE  
**13.271.18**  
 18 cm/7"

Peripheal-Gefäßklemmen  
 Peripheal Vascular Clamps  
 Pincés-clamps, vasculaires périphériques  
 Pinzas para vasos periféricos  
 Pinze vascolari periferali



DALE

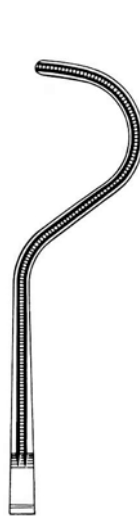

**13.273.17**  
 17 cm/6½"

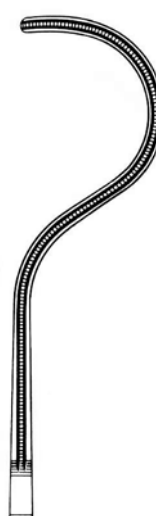

**13.273.18**  
 18 cm/7"

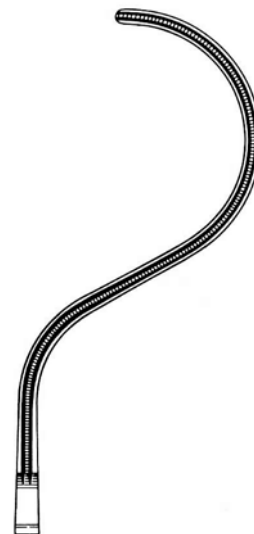

**13.273.19**  
 19 cm/7¼"



Atraumatische Gefäßklemmen  
 Atraumatic Vascular Clamps  
 Pincés vasculaires atraumatiques  
 Pinzas vasculares atraumáticas  
 Pinze vascolari atraumatiche

**dimeda**<sup>®</sup>

SURGICAL INSTRUMENTS

Aorta-Anastomosenklemmen  
 Aorta-Anastomosis Clamps  
 Pincés-clamps pour anastomoses d'aorte  
 Pinzas clamps para anastomosis de aorta  
 Pinze aortiche

Atraumatische Mehrzweckklemmen  
 Atraumatic Multi-Purpose Clamps  
 Pincés-clamps polyvalentes  
 Pinzas clamps para usos varios  
 Pinze atraumatiche per diversi usi

**ATRAUMA**



DE BAKEY

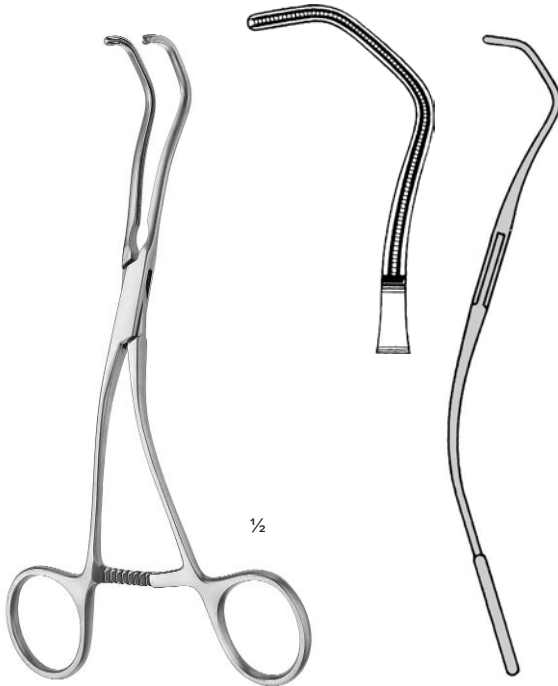

DE BAKEY  
**13.281.17**  
 17 cm/6<sup>3</sup>/<sub>4</sub>"



BECK  
**13.283.17**  
 17 cm/6<sup>3</sup>/<sub>4</sub>"



DE BAKEY-BECK

Atraumatische Mehrzweckklemmen  
 Atraumatic Multi-Purpose Clamps  
 Pincés-clamps polyvalentes  
 Pinzas clamps para usos varios  
 Pinze atraumatiche per diversi usi



**13.284.20**  
 20,5 cm/8"

**13.284.21**  
 21 cm/8<sup>1</sup>/<sub>4</sub>"

Atraumatische Gefäßklemmen  
Atraumatic Vascular Clamps  
Pincés vasculaires atraumatiques  
Pinzas vasculares atraumáticas  
Pinze vascolari atraumatiche

**dimed**<sup>®</sup>

SURGICAL INSTRUMENTS

**ATRAUMA**



DE BAKEY

Präparier- und Ligaturklemmen  
Dissecting and Ligature Clamps  
Pincés à dissection et passe-fil  
Pinzas de disección y para ligaduras  
Pinze per dissezione e per legature



DE BAKEY  
**13.285.24**  
24 cm/9½"



DE BAKEY  
**13.287.24**  
24 cm/9½"

Atraumatische Gefäßklemmen  
 Atraumatic Vascular Clamps  
 Pincas vasculares atraumaticas  
 Pinzas vasculares atraumaticas  
 Pinze vascolari atraumatiche

**dimed**<sup>®</sup>

SURGICAL INSTRUMENTS

**ATRAUMA**



DE BAKEY



Coarctationsklemmen  
 Coarction Clamps  
 Pincas à coarctacion  
 Pinzas para coarctación  
 Pinze per coartazione



**13.288.21**  
 21 cm/8¼"



**13.288.23**  
 23 cm/9"



**13.288.27**  
 27 cm/10½"



**13.288.31**  
 31 cm/12¼"



Coarctationsklemmen  
 Coarction Clamps  
 Pincas à coarctacion  
 Pinzas para coarctación  
 Pinze per coartazione

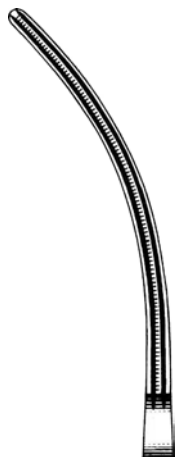

**13.289.21**  
 21 cm/8¼"



**13.289.23**  
 23 cm/9"



**13.289.27**  
 27 cm/10½"



**13.289.31**  
 31 cm/12¼"

**ATRAUMA**



DE BAKEY

Anastomosenklemmen, Kindergrößen  
 Anastomosis Clamps, Pediatric  
 Pincés à anastomose, pédiatriques  
 Pinzas para anastomosis, pediátricas  
 Pinze per anastomosi, pediatriche

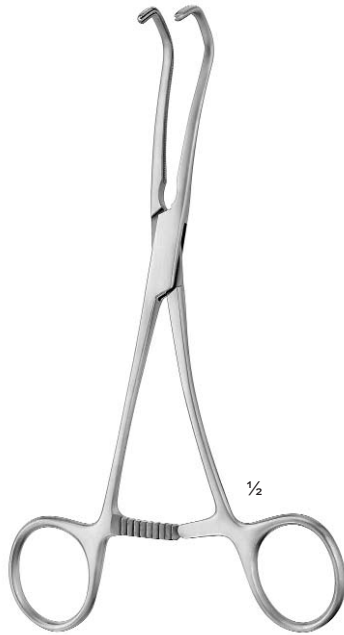

DERRA



**13.291.16**  
16 cm/6<sup>1</sup>/<sub>4</sub>"



**13.291.17**  
17 cm/6<sup>3</sup>/<sub>4</sub>"

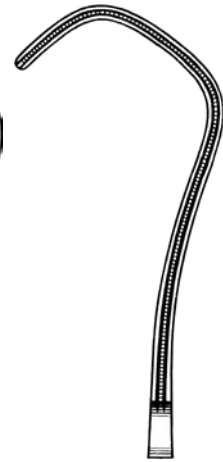

**13.291.18**  
18 cm/7"

Anastomosenklemmen  
 Anastomosis Clamps  
 Pincés à anastomose  
 Pinzas para anastomosis  
 Pinze per anastomosi



DE BAKEY

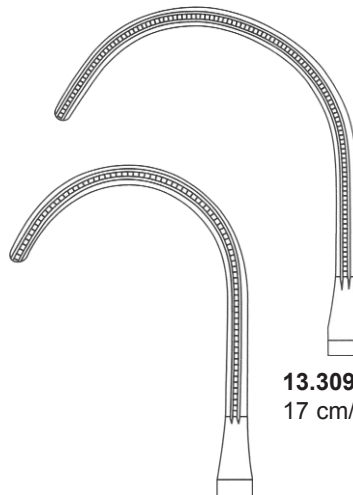

**13.309.16**  
16 cm/6<sup>1</sup>/<sub>4</sub>"

**13.309.17**  
17 cm/6<sup>3</sup>/<sub>4</sub>"

Coarctationsklemmen  
 Coarction Clamps  
 Pincés à coarctacion  
 Pinzas para coarctación  
 Pinze per coarctazione

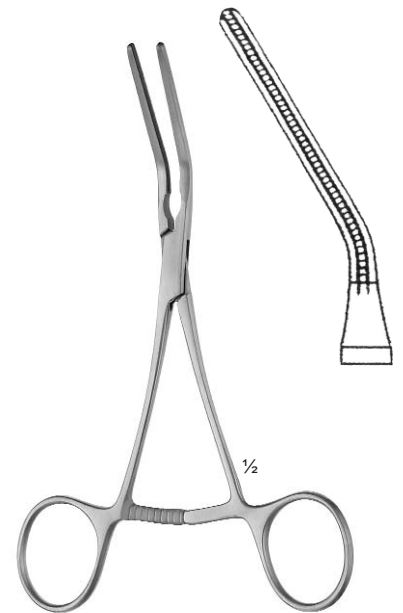

DE BAKEY  
**13.305.15**  
15 cm/6"

Atraumatische Gefäßklemmen  
 Atraumatic Vascular Clamps  
 Pincès vasculaires atraumatiques  
 Pinzas vasculares atraumáticas  
 Pinze vascolari atraumatiche

**dimed**<sup>®</sup>

SURGICAL INSTRUMENTS

Coarctationsklemmen  
 Coarction Clamps  
 Pincès à coarctacion  
 Pinzas para coarctación  
 Pinze per coartazione

**ATRAUMA**



DE BAKEY

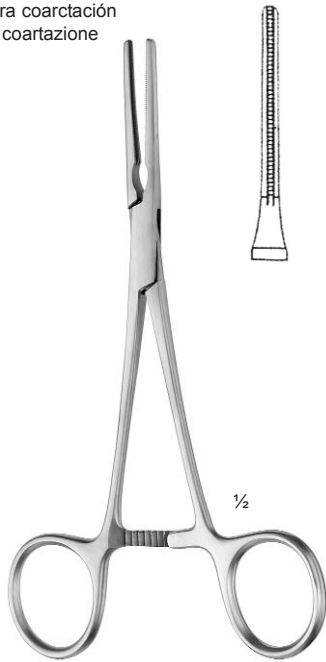

DE BAKEY  
**13.302.16**  
 16 cm/6¼"

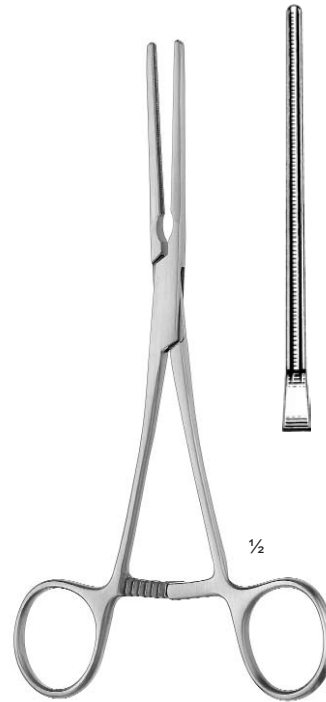

DE BAKEY  
**13.302.17**  
 17 cm/6½"

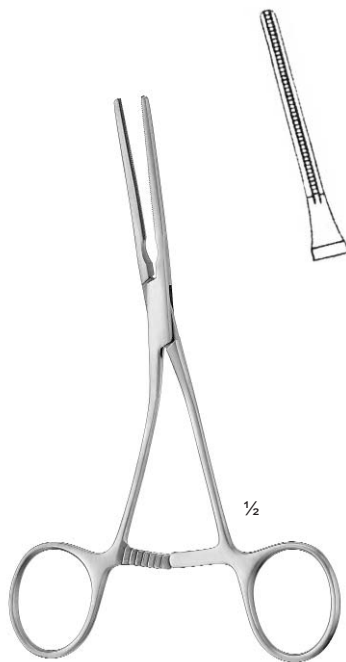

DE BAKEY  
**13.303.15**  
 15 cm/6"

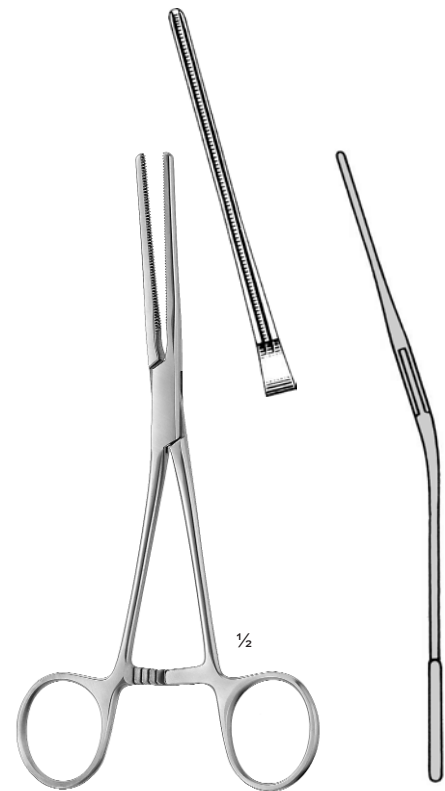

DE BAKEY  
**13.307.17**  
 17 cm/6½"

**ATRAUMA**



DE BAKEY

Coarctationsklemmen  
 Coarction Clamps  
 Pincés à coarctacion  
 Pinzas para coarctación  
 Pinze per coartazione



DE BAKEY

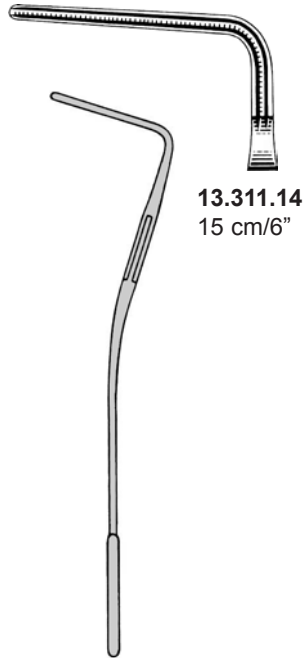

**13.311.14**  
15 cm/6"

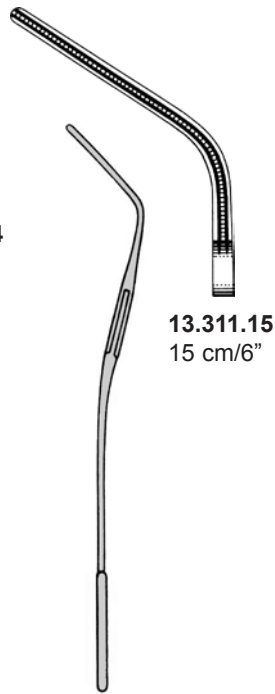

**13.311.15**  
15 cm/6"

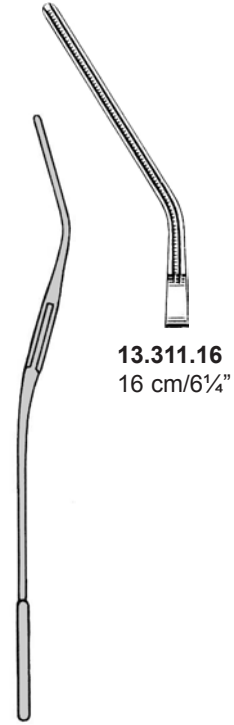

**13.311.16**  
16 cm/6 1/4"



GLOVER  
**13.321.17**  
17 cm/6 3/4"



**13.323.17**  
17 cm/6 3/4"

**ATRAUMA**



DE BAKEY

Anastomosenklemmen  
 Anastomosis Clamps  
 Pincés à anastomose  
 Pinzas para anastomosis  
 Pinze per anastomosi

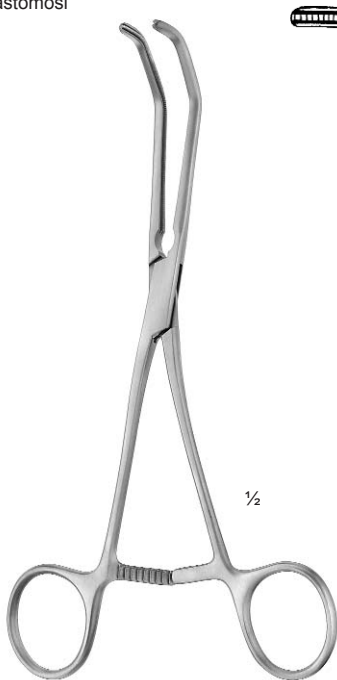

DE BAKEY REYNOLDS

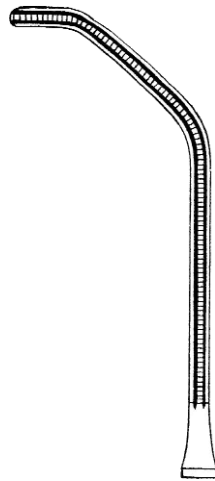

**13.329.01**  
18 cm/7"

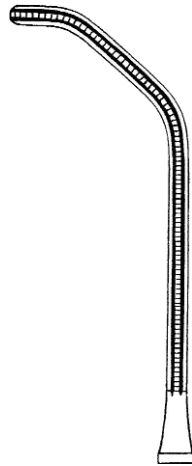

**13.329.02**  
18 cm/7"

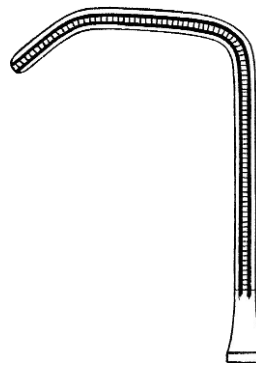

**13.329.03**  
16,5 cm/6½"

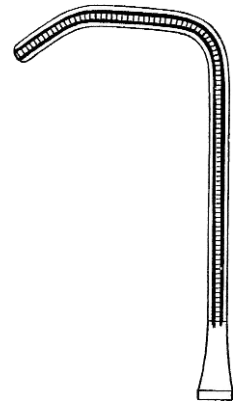

**13.329.04**  
16,5 cm/6½"

Aortaklemmen  
 Aortic Clamp  
 Pince-clamp à aorte  
 Pinza clamp para aorta  
 Pinza per aorta

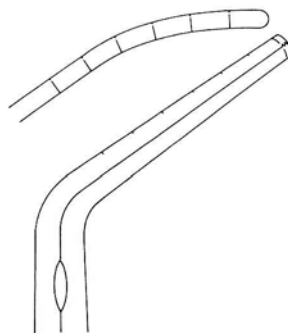
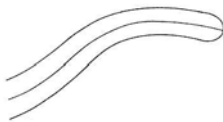

**13.333.16**  
16 cm/6¼"

links gebogen  
 curved to left  
 courbe à gauche  
 curva a la izquierda  
 curva a sinistra

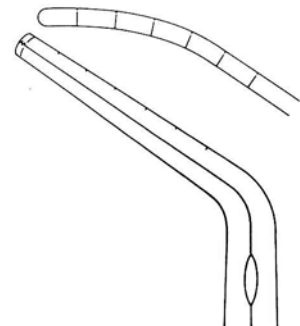

**13.335.16**  
16 cm/6¼"

rechts gebogen  
 curved to right  
 courbe à droite  
 curva a la derecha  
 curva a destra



SUBRAMANIAN-MINIATURE  
**13.331.15**  
15,5 cm/6"

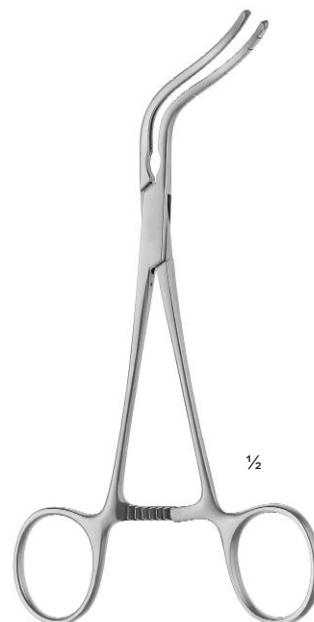

SUBRAMANIAN



**ATRAUMA**



DE BAKEY

Aortaklemmen  
 Aortic Clamp  
 Pince-clamp à aorte  
 Pinza clamp para aorta  
 Pinza per aorta

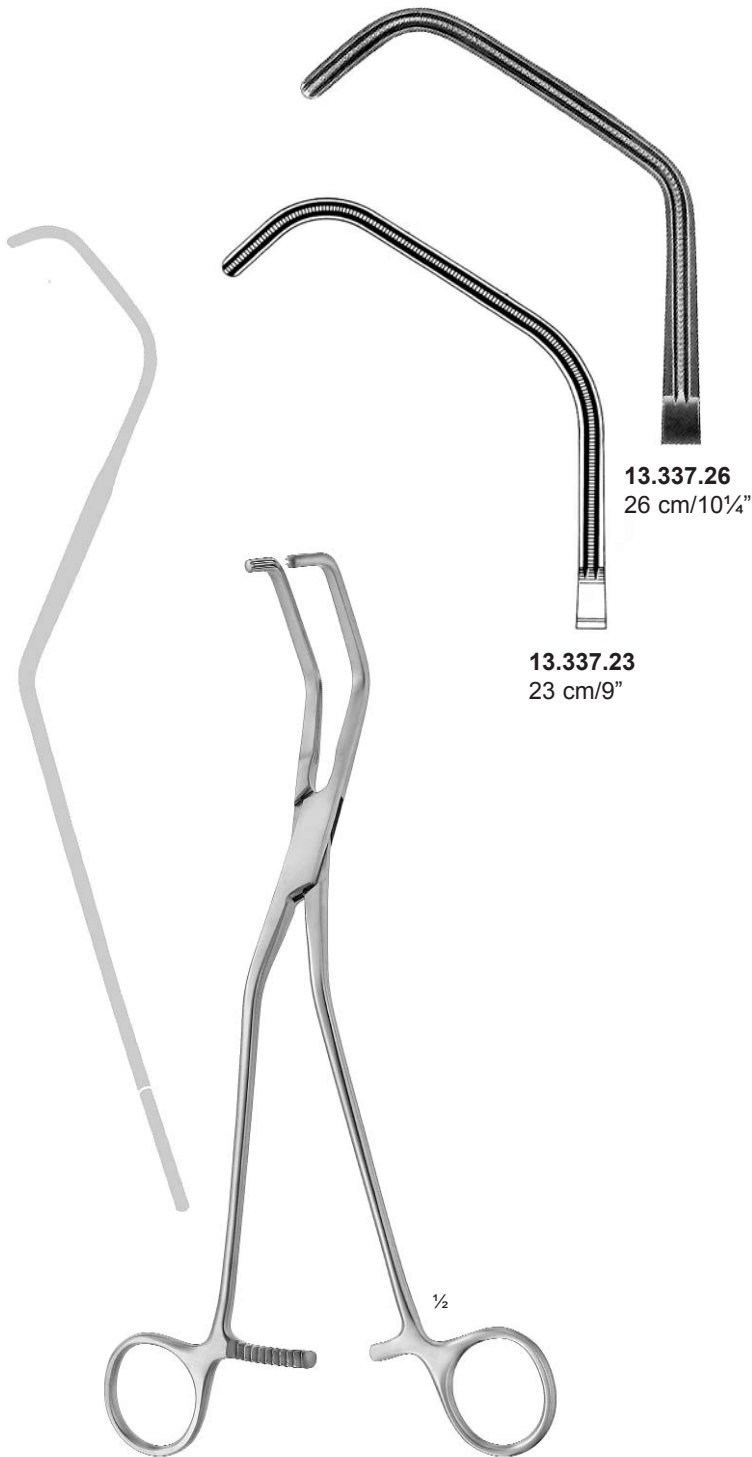

**13.337.26**  
 26 cm/10¼"

**13.337.23**  
 23 cm/9"

OCHSNER



**DIETRICH**  
**13.339.21**  
 21 cm/8¼"



Atraumatische Gefäßklemmen  
 Atraumatic Vascular Clamps  
 Pincés vasculaires atraumatiques  
 Pinzas vasculares atraumáticas  
 Pinze vascolari atraumatiche

**dimeda**<sup>®</sup>

SURGICAL INSTRUMENTS

Ligaturklemmen  
 Ligature Clamps  
 Pincés à passe-fil  
 Pinzas para ligaduras  
 Pinze per legature

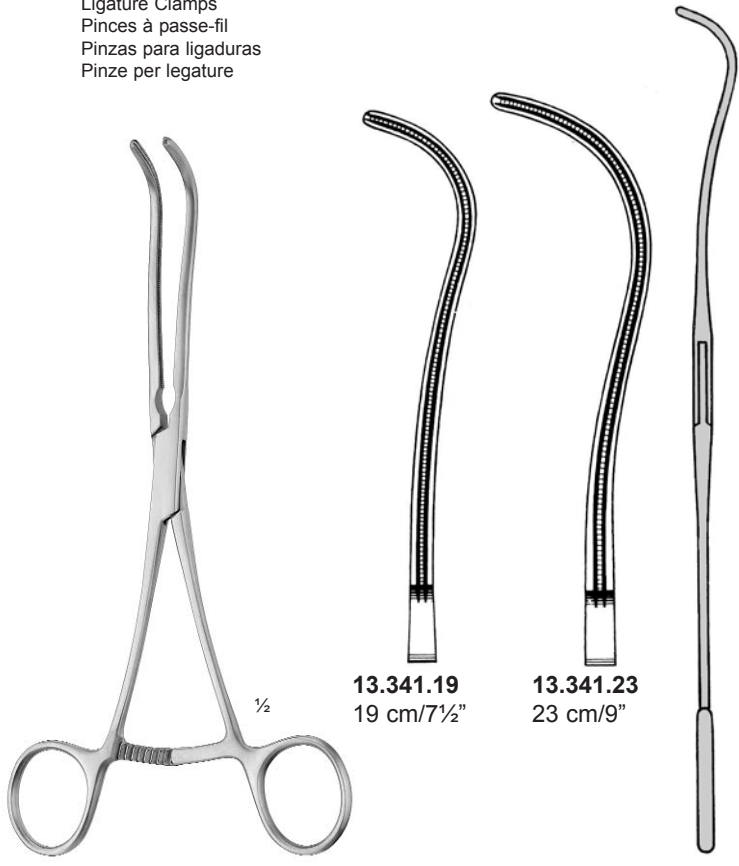

**13.341.19**  
 19 cm/7½"

**13.341.23**  
 23 cm/9"

DE BAKEY

Anastomosenklemmen  
 Anastomosis Clamps  
 Pincés à anastomose  
 Pinzas para anastomosis  
 Pinze per anastomosi

**ATRAUMA**



DE BAKEY



DE BAKEY  
**13.341.20**  
 20 cm/8"

Carotis-Shuntklemmen  
 Carotid Shunt Clamps  
 Pincés pour carotide  
 Pinzas para shunt carótido  
 Pinze carotis

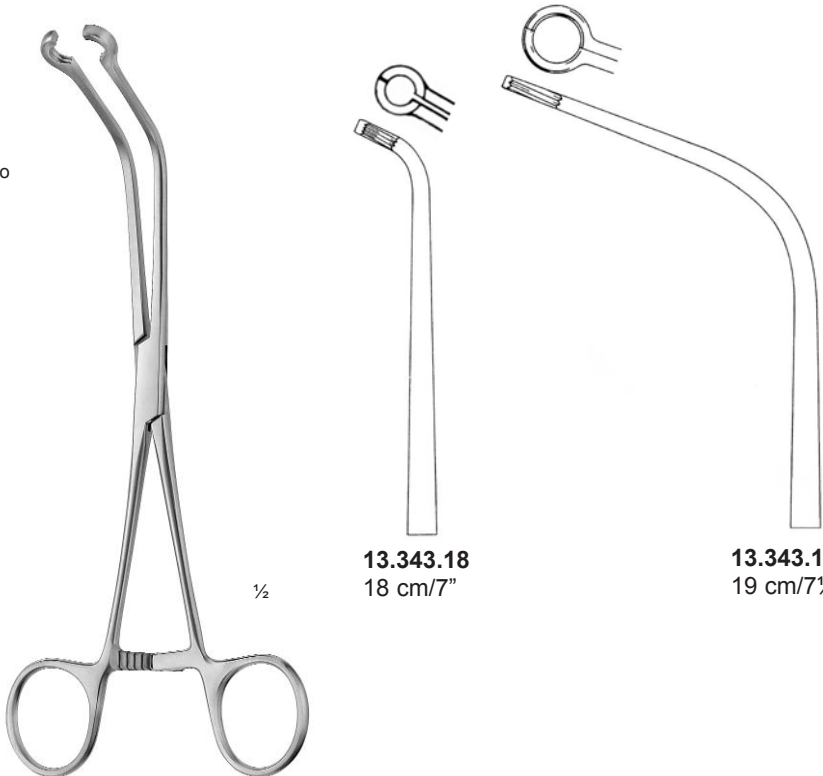

**13.343.18**  
 18 cm/7"

**13.343.19**  
 19 cm/7½"

JAVID

**ATRAUMA**



DE BAKEY

Peripheal-Gefäßklemmen  
 Peripheal Vascular Clamps  
 Pincés-clamps, vasculaires périphériques  
 Pinzas para vasos periféricos  
 Pinze vascolari periferali

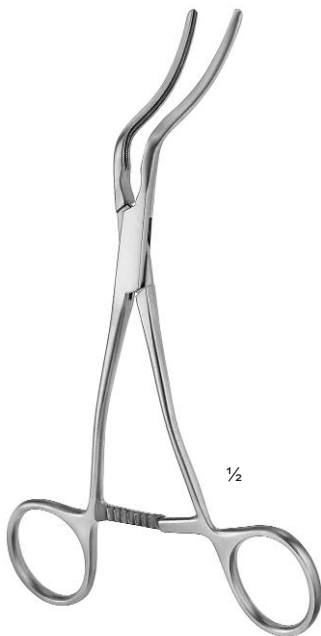

1/2

MARTIN

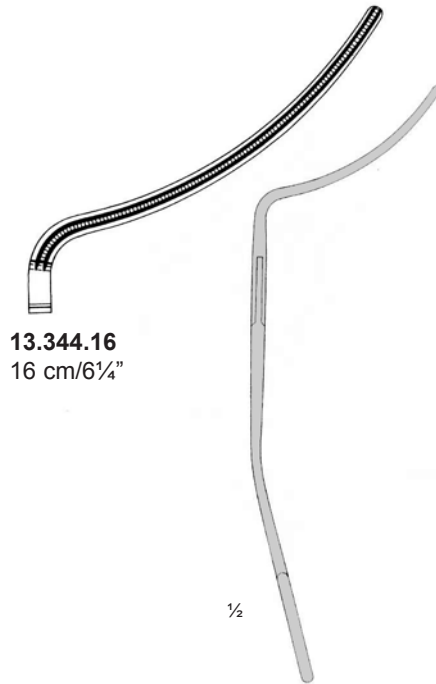

**13.344.16**  
 16 cm/6 1/4"

1/2

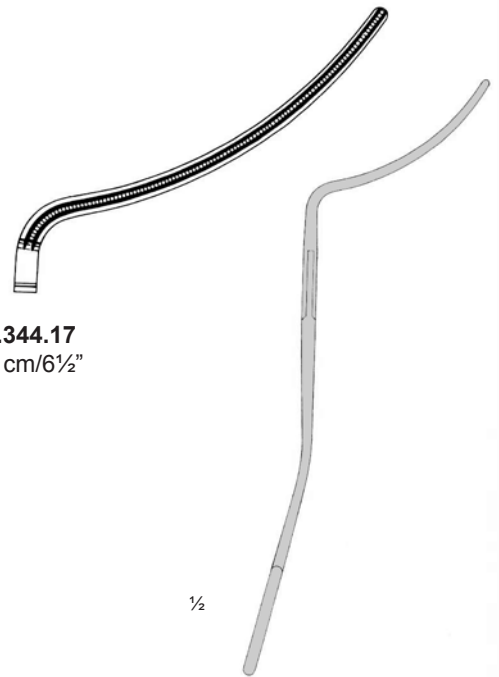

**13.344.17**  
 17 cm/6 1/2"

1/2

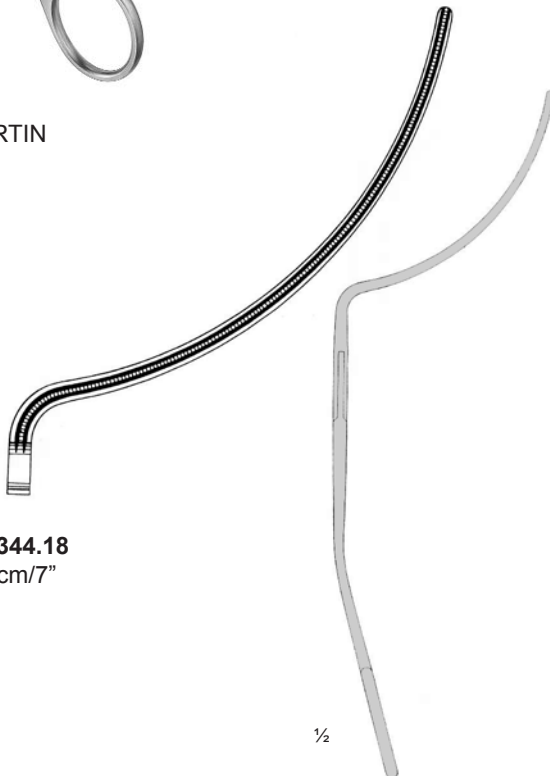

**13.344.18**  
 18 cm/7"

1/2

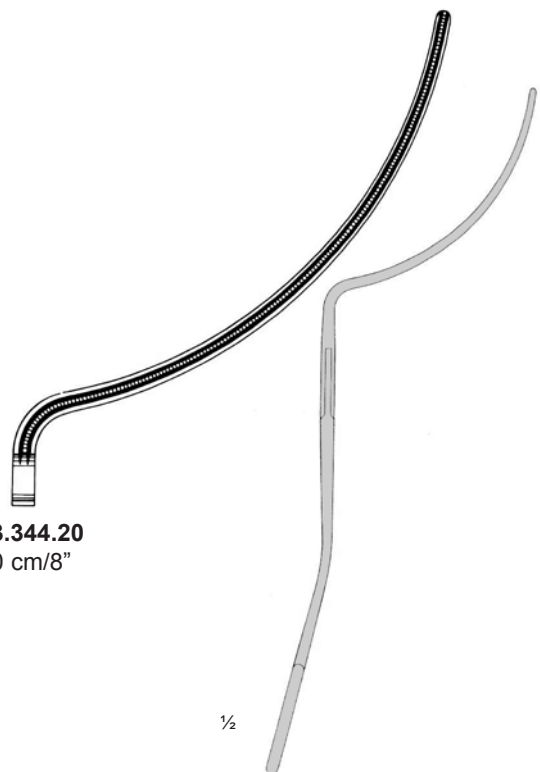

**13.344.20**  
 20 cm/8"

1/2

Atraumatische Gefäßklemmen  
Atraumatic Vascular Clamps  
Pinces vasculaires atraumatiques  
Pinzas vasculares atraumáticas  
Pinze vascolari atraumatiche

**dimed**<sup>®</sup>

SURGICAL INSTRUMENTS

Präparier- und Ligaturklemmen  
Dissecting and Ligature Clamps  
Pinces à dissection et passe-fil  
Pinzas de disección y para ligaduras  
Pinze per dissezione e per legature

**ATRAUMA**



DE BAKEY



DE BAKEY-RUMMEL



**13.345.01**  
25 cm/10"

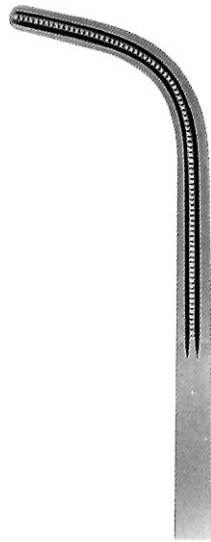

**13.345.02**  
25 cm/10"



DE BAKEY-MC QUIGGMIXTER  
**13.345.21**  
21 cm/8 1/4"

**ATRAUMA**



DE BAKEY

Präparier- und Ligaturklemmen  
 Dissecting and Ligature Clamps  
 Pincés à dissection et passe-fil  
 Pinzas de disección y para ligaduras  
 Pinze per dissezione e per legature

Profunda-Klemmen  
 Profunda Clamps  
 Pincés-clamps pour profunda  
 Pinzas clamps para profunda  
 Pinze per profunda



DE BAKEY-MIXTER  
**13.345.28**  
 28,5 cm/11¼"

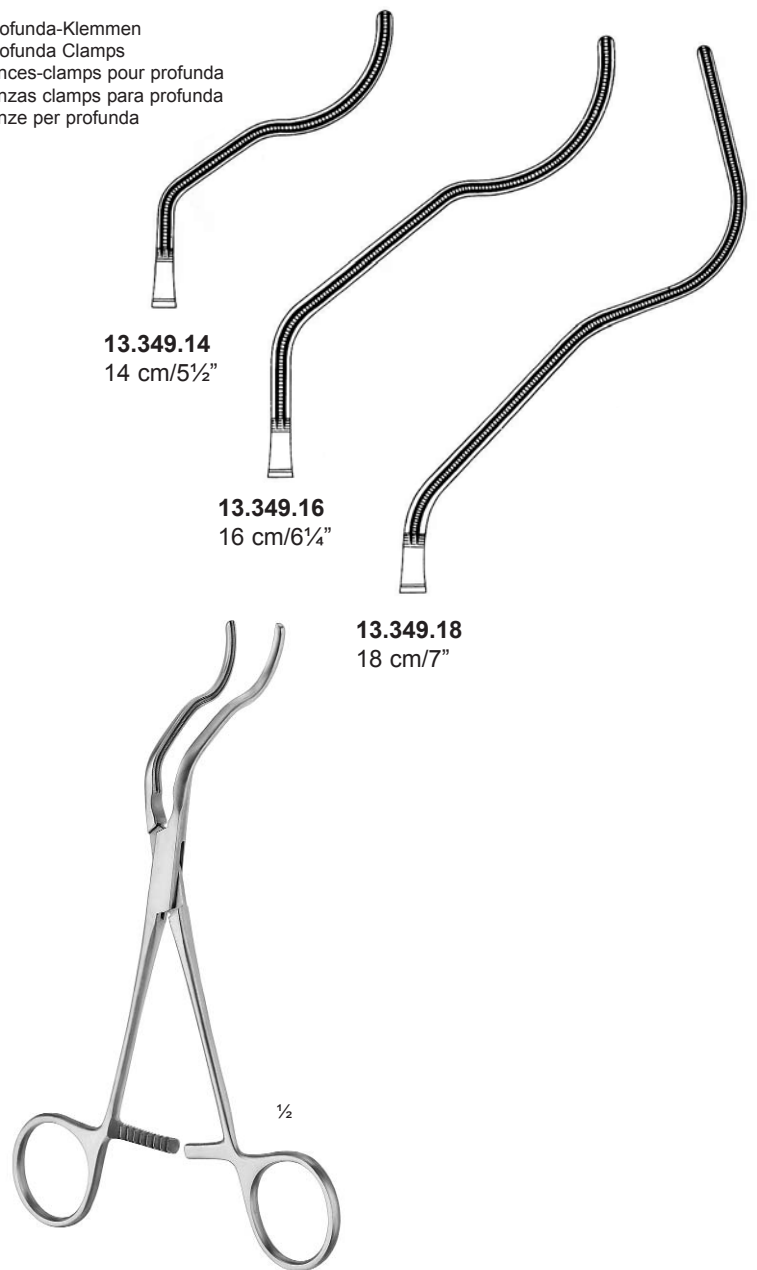

**13.349.14**  
 14 cm/5½"

**13.349.16**  
 16 cm/6¼"

**13.349.18**  
 18 cm/7"

GREGORY

Atraumatische Gefäßklemmen  
 Atraumatic Vascular Clamps  
 Pincés vasculaires atraumatiques  
 Pinzas vasculares atraumáticas  
 Pinze vascolari atraumatiche

**dimed**<sup>®</sup>

SURGICAL INSTRUMENTS

Bulldogklemmen mit Ringgriff  
 Ring Bulldog clamps  
 Clamps Bulldog  
 Clamps Bulldog  
 Pinze Bulldog

**ATRAUMA**



COOLEY

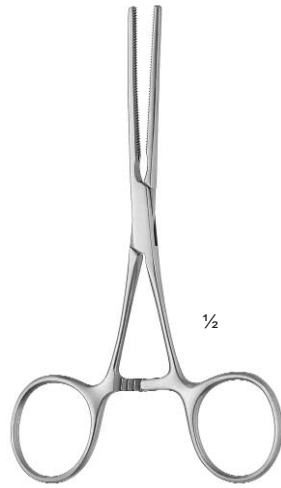

½

COOLEY

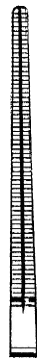

**13.350.13**  
 12,5 cm/5"

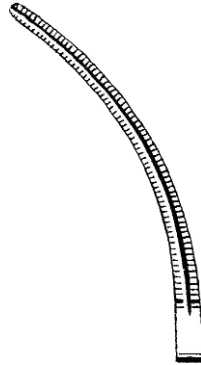

**13.351.13**  
 12,5 cm/5"

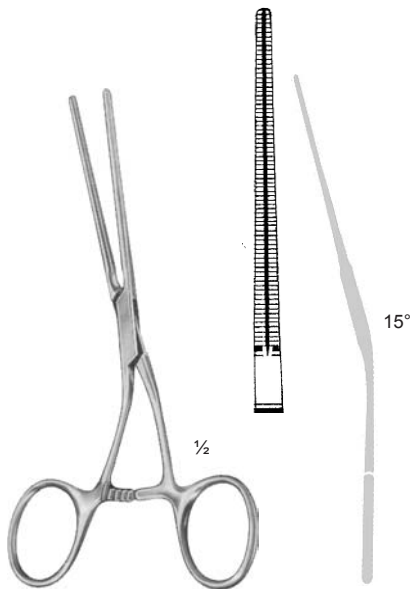

½

COOLEY  
**13.353.13**  
 13,5 cm/5¼"

15°



½

COOLEY  
**13.359.10**  
 10,5 cm/4¼"

**ATRAUMA**



COOLEY

Bulldogklemmen mit Ringgriff  
 Ring Bulldog clamps  
 Clamps Bulldog  
 Clamps Bulldog  
 Pinze Bulldog

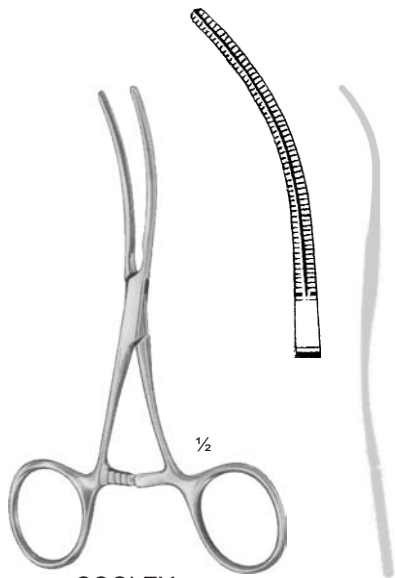

COOLEY  
**13.355.13**  
 13,0 cm/5"

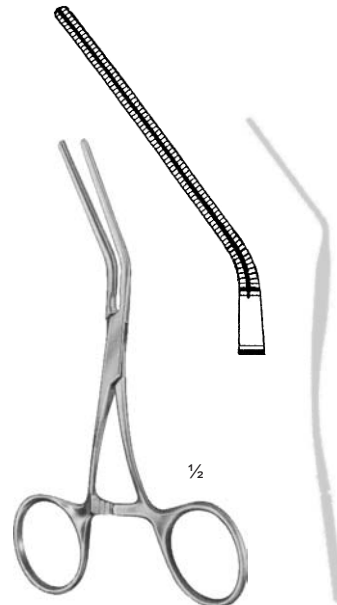

COOLEY  
**13.357.12**  
 12,5 cm/5"

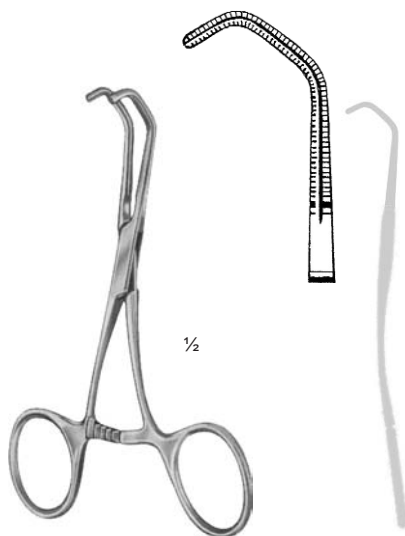

COOLEY  
**13.361.12**  
 12,0 cm/4¾"

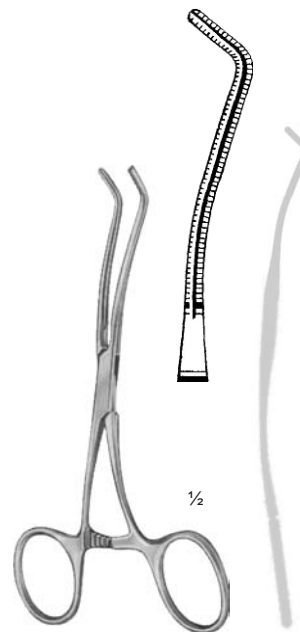

COOLEY  
**13.363.13**  
 13,5 cm/5¼"

Atraumatische Gefäßklemmen  
 Atraumatic Vascular Clamps  
 Pincés vasculaires atraumatiques  
 Pinzas vasculares atraumáticas  
 Pinze vascolari atraumatiche

**dimed**<sup>®</sup>

SURGICAL INSTRUMENTS

**ATRAUMA**



COOLEY

Katheterklemmen  
 Catheter clamps  
 Pincés pour sondes  
 Pinzas para catéteres  
 Pinze per cateteri



COOLEY

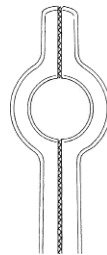

**13.371.24**  
 16 cm/6¼"  
 24 Charr.

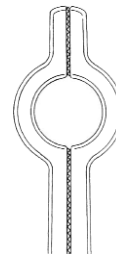

**13.371.26**  
 16 cm/6¼"  
 26 Charr.

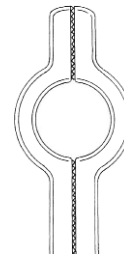

**13.371.28**  
 20 cm/8"  
 28 Charr.

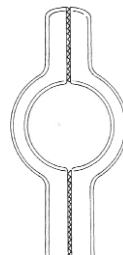

**13.373.30**  
 20 cm/8"  
 30 Charr.



**13.373.32**  
 20 cm/8"  
 32 Charr.

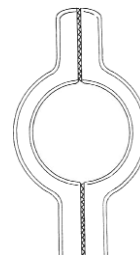

**13.373.36**  
 20 cm/8"  
 36 Charr.

**ATRAUMA**



COOLEY

Neonatal- und Kinderklemmen, extra feine Modelle  
 Neonatal and Childrens Clamps, extra delicate patterns  
 Pincès-clamps pour des nouveaux-nés et des enfants, modèles très fins  
 Pinzas clamps para recién nacidos y niños, modelos muy finos  
 Pinze pediatriche, modelli molto fini



**13.376.14**  
14 cm/5 1/2"

**13.377.14**  
14 cm/5 1/2"

COOLEY

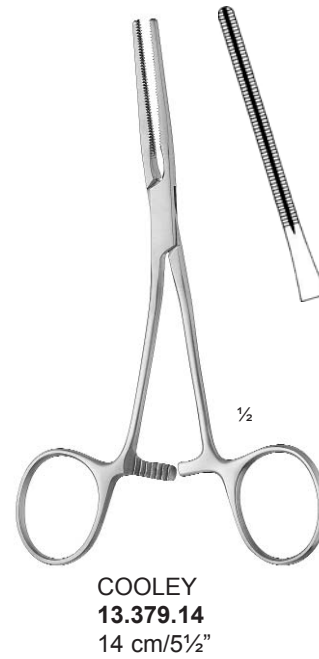

COOLEY  
**13.379.14**  
14 cm/5 1/2"

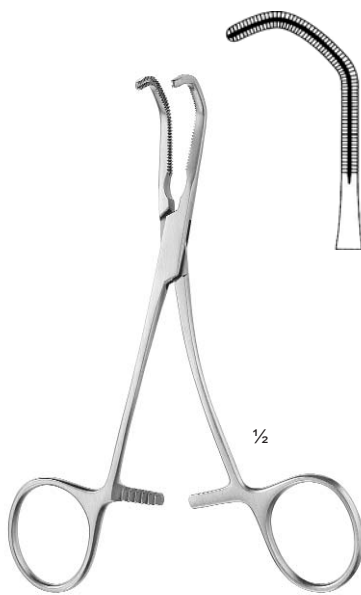

COOLEY  
**13.380.14**  
14 cm/5 1/2"

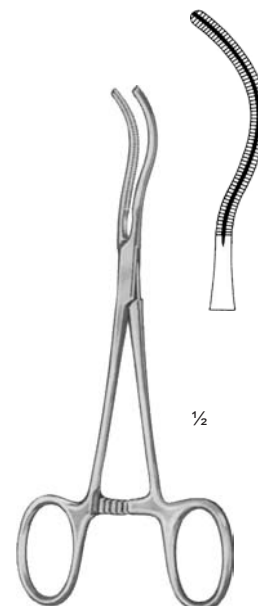

COOLEY  
**13.381.14**  
14 cm/5 1/2"



Atraumatische Gefäßklemmen  
 Atraumatic Vascular Clamps  
 Pincas vasculaires atraumatiques  
 Pinzas vasculares atraumáticas  
 Pinze vascolari atraumatiche

**dimed**<sup>®</sup>

SURGICAL INSTRUMENTS

Coarctationsklemmen  
 Coarction Clamps  
 Pincas à coarctacion  
 Pinzas para coarctación  
 Pinze per coartazione

Atraumatische Mehrzweckklemmen  
 Atraumatic Multi-Purpose Clamps  
 Pincas-clamps polyvalentes  
 Pinzas clamps para usos varios  
 Pinze atraumatiche per diversi usi

**ATRAUMA**



COOLEY

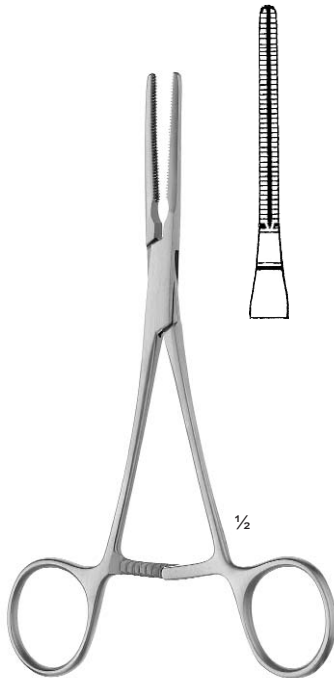

COOLEY  
**13.376.16**  
 16 cm/6¼"

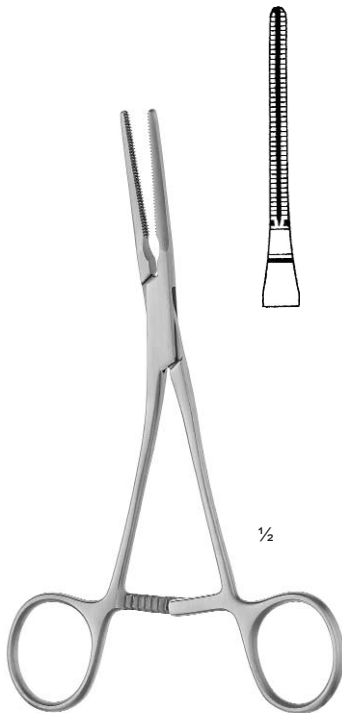

COOLEY  
**13.377.16**  
 16 cm/6¼"



COOLEY  
**13.405.27**  
 28,5 cm/11¼"

**ATRAUMA**



COOLEY

Coarctationsklemmen  
 Coarction Clamps  
 Pincés à coarctacion  
 Pinzas para coarctación  
 Pinze per coartazione

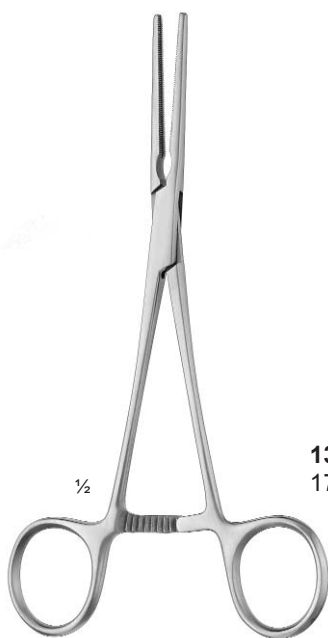

**13.410.17**  
 17 cm/6<sup>3</sup>/<sub>4</sub>"

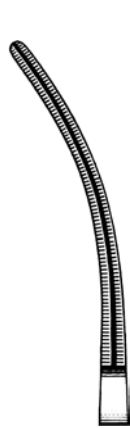

**13.413.17**  
 17 cm/6<sup>3</sup>/<sub>4</sub>"

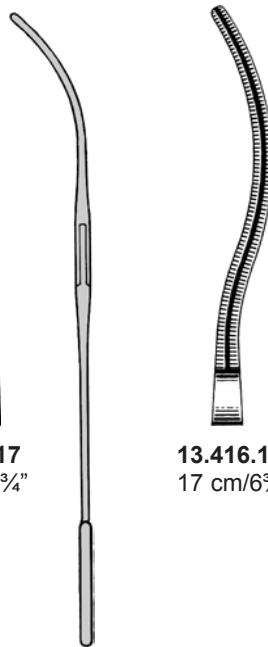

**13.416.17**  
 17 cm/6<sup>3</sup>/<sub>4</sub>"

COOLEY

Coarctationsklemmen  
 Coarction Clamps  
 Pincés à coarctacion  
 Pinzas para coarctación  
 Pinze per coartazione



**COOLEY**  
**13.411.17**  
 17 cm/6<sup>3</sup>/<sub>4</sub>"

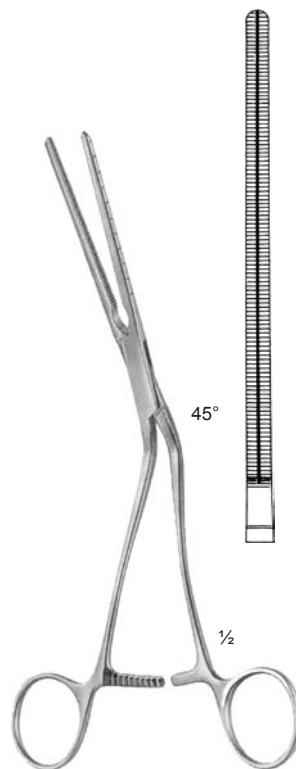

**COOLEY**  
 21 cm/8<sup>1</sup>/<sub>4</sub>" **13.417.21**  
 25 cm/10" **13.417.25**

Iliaca-Klemmen  
 Iliac Clamps  
 Pincés-clamps à iliaque  
 Pinzas clamps para iliaca  
 Pinze per iliaca

Atraumatische Gefäßklemmen  
 Atraumatic Vascular Clamps  
 Pincés vasculaires atraumatiques  
 Pinzas vasculares atraumáticas  
 Pinze vascolari atraumatiche

**dimed**<sup>®</sup>

SURGICAL INSTRUMENTS

**ATRAUMA**



COOLEY

Anastomosenklemmen  
 Anastomosis Clamps  
 Pincés à anastomose  
 Pinzas para anastomosis  
 Pinze per anastomosi

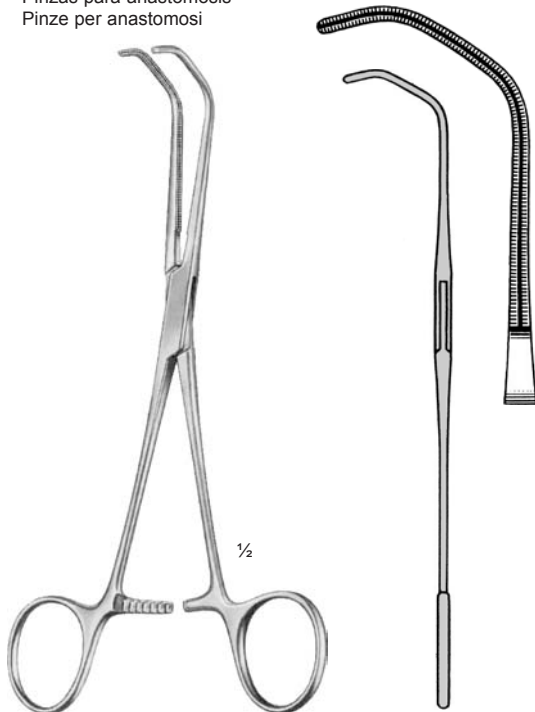

**COOLEY-BECK**  
**13.419.17**  
 17 cm/6<sup>3</sup>/<sub>4</sub>"

Neonatal- und Kinderklemmen  
 Neonatal and Childrens Clamps  
 Pincés-clamps pour des nouveaux-nés et des enfants  
 Pinzas clamps para recién nacidos y niños  
 Pinze pediatriche

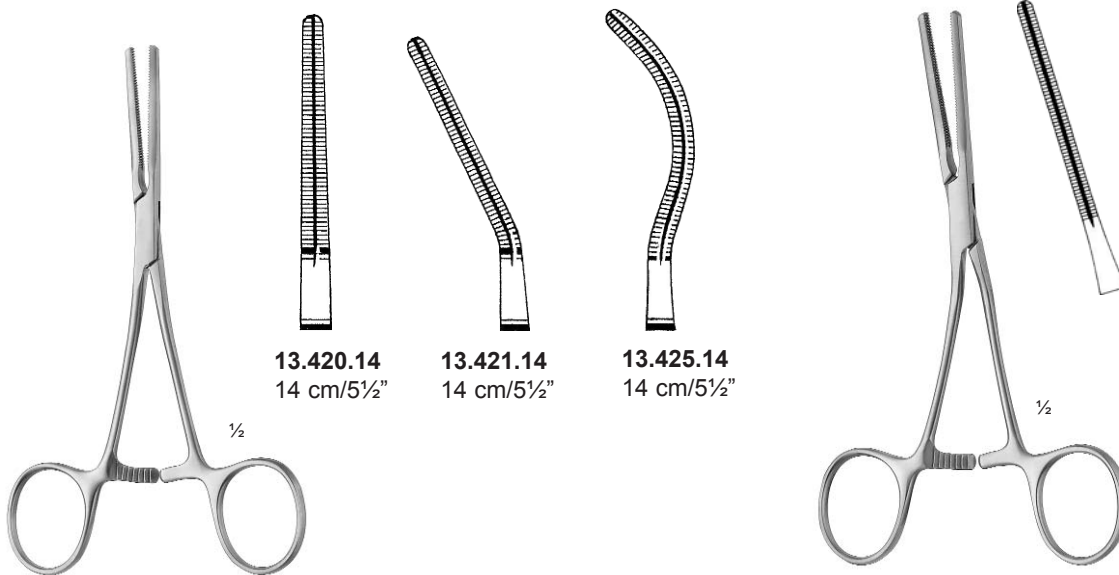

**13.420.14**  
 14 cm/5<sup>1</sup>/<sub>2</sub>"

**13.421.14**  
 14 cm/5<sup>1</sup>/<sub>2</sub>"

**13.425.14**  
 14 cm/5<sup>1</sup>/<sub>2</sub>"

**COOLEY**  
**13.423.14**  
 14 cm/5<sup>1</sup>/<sub>2</sub>"

**COOLEY**

**ATRAUMA**



COOLEY

Anastomosenklemmen  
 Anastomosis Clamps  
 Pincès à anastomose  
 Pinzas para anastomosis  
 Pinze per anastomosi

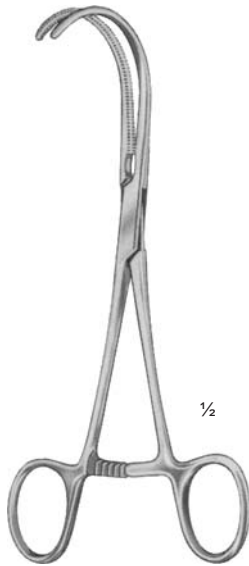

COOLEY-BECK

½



**13.426.15**  
15 cm/6"



**13.426.16**  
15,5 cm/6"

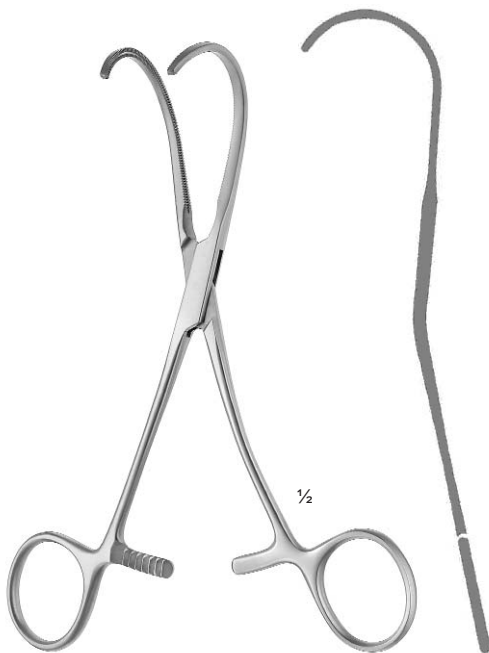

COOLEY

½



**13.427.14**  
17 cm/6¾"



**13.427.15**  
17 cm/6¾"

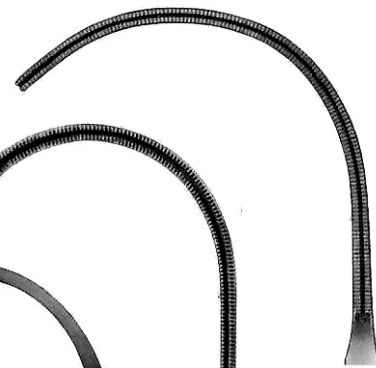

**13.427.16**  
17 cm/6¾"

Atraumatische Gefäßklemmen  
Atraumatic Vascular Clamps  
Pinces vasculaires atraumatiques  
Pinzas vasculares atraumáticas  
Pinze vascolari atraumatiche

**dimed**<sup>®</sup>

SURGICAL INSTRUMENTS

Anastomosenklemmen  
Anastomosis Clamps  
Pinces à anastomose  
Pinzas para anastomosis  
Pinze per anastomosi

**ATRAUMA**



COOLEY

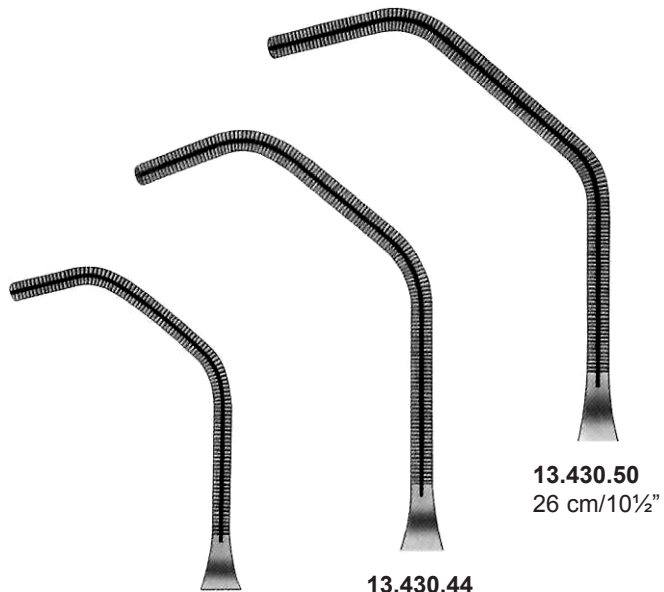

**13.430.31**  
20,5 cm/8"

**13.430.44**  
26 cm/10<sup>1</sup>/<sub>4</sub>"

**13.430.50**  
26 cm/10<sup>1</sup>/<sub>2</sub>"

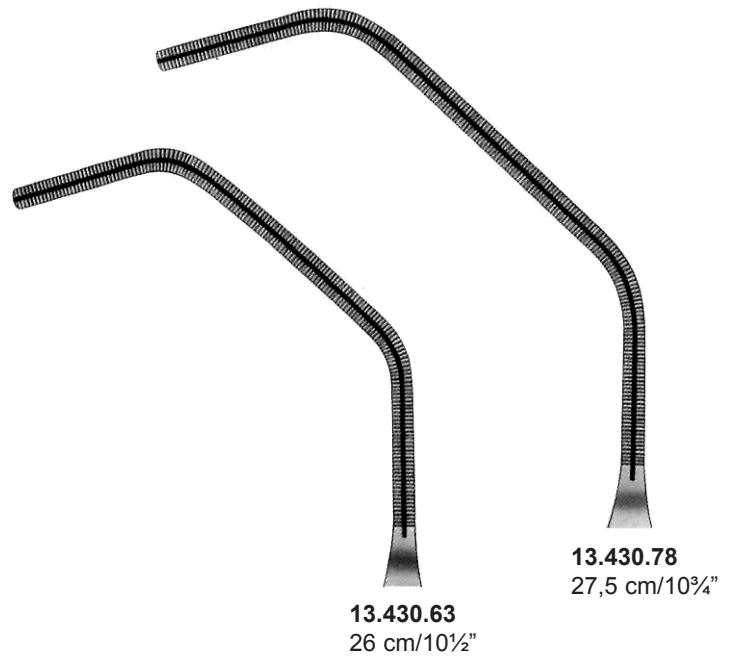

**13.430.63**  
26 cm/10<sup>1</sup>/<sub>2</sub>"

**13.430.78**  
27,5 cm/10<sup>3</sup>/<sub>4</sub>"

**ATRAUMA**



COOLEY

Atraumatische Mehrzweckklemmen  
 Atraumatic Multi-Purpose Clamps  
 Pincés-clamps polyvalentes  
 Pinzas clamps para usos varios  
 Pinze atraumatiche per diversi usi



COOLEY

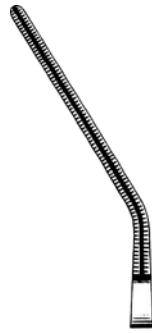

**13.431.25**  
17 cm/6<sup>3</sup>/<sub>4</sub>"



**13.431.45**  
15,5 cm/6<sup>1</sup>/<sub>4</sub>"

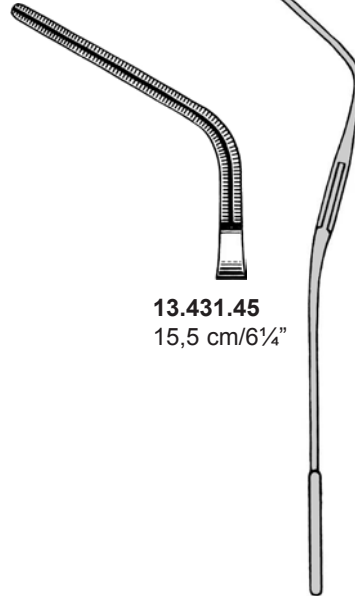

**13.431.90**  
15 cm/6"

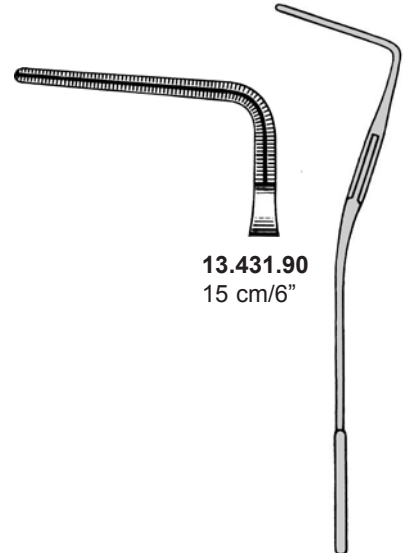

Neonatal- und Kinderklemmen  
 Neonatal and Childrens Clamps  
 Pincés-clamps pour des nouveaux-nés et des enfants  
 Pinzas clamps para recién nacidos y niños  
 Pinze pediatriche

Anastomosenklemmen  
 Anastomosis Clamps  
 Pincés à anastomose  
 Pinzas para anastomosis  
 Pinze per anastomosi

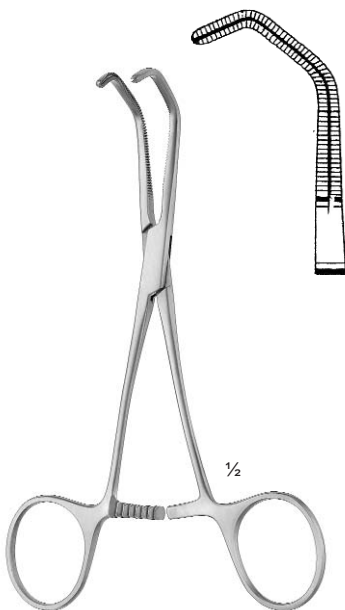

COOLEY  
**13.433.14**  
14 cm/5<sup>1</sup>/<sub>2</sub>"

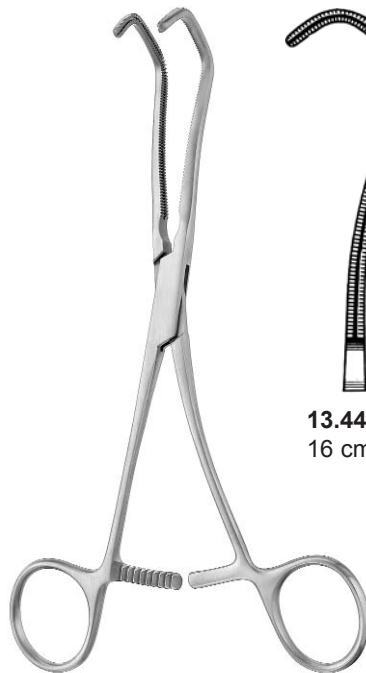

COOLEY-DERRA

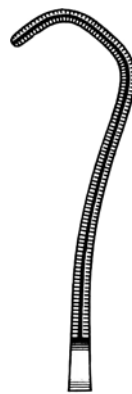

**13.441.16**  
16 cm/6<sup>1</sup>/<sub>4</sub>"

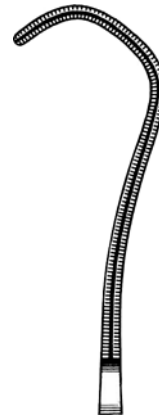

**13.441.17**  
17 cm/6<sup>3</sup>/<sub>4</sub>"

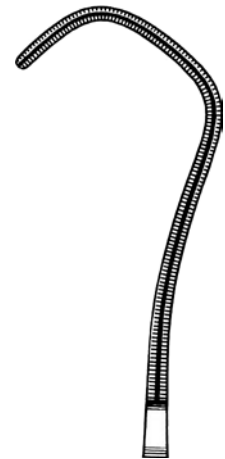

**13.441.18**  
18 cm/7"

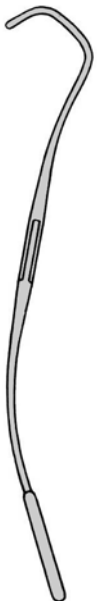

Atraumatische Gefäßklemmen  
 Atraumatic Vascular Clamps  
 Pincès vasculaires atraumatiques  
 Pinzas vasculares atraumáticas  
 Pinze vascolari atraumatiche

**dimed**<sup>®</sup>

SURGICAL INSTRUMENTS

Anastomosenklemmen  
 Anastomosis Clamps  
 Pincès à anastomose  
 Pinzas para anastomosis  
 Pinze per anastomosi

**ATRAUMA**



COOLEY



COOLEY

1/2

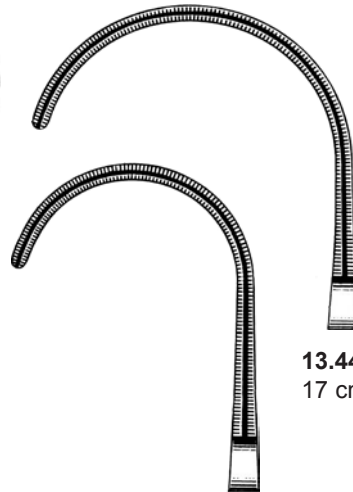

**13.449.17**  
17 cm/6 3/4"

**13.447.17**  
16 cm/6 1/4"



COOLEY

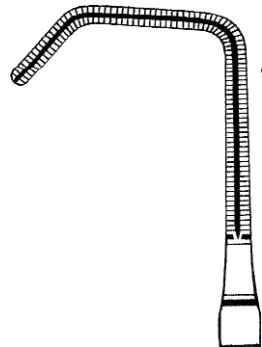

**13.451.16**  
16,5 cm/6 1/2"

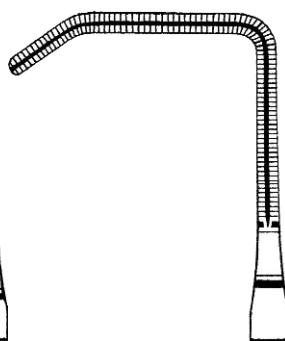

**13.452.16**  
16,5 cm/6 1/2"

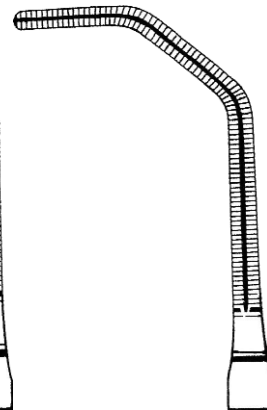

**13.453.16**  
17,5 cm/7"

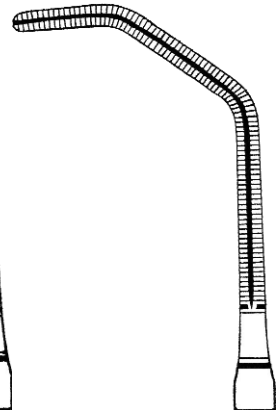

**13.455.17**  
17,5 cm/7"



**ATRAUMA**



COOLEY

Atraumatische Mehrzweckklemmen  
 Atraumatic Multi-Purpose Clamps  
 Pincas-clamps polyvalentes  
 Pinzas clamps para usos varios  
 Pinze atraumatiche per diversi usi

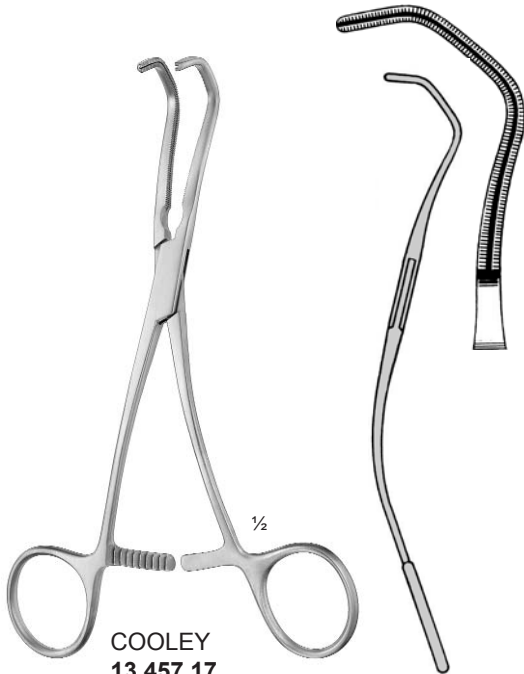

COOLEY  
**13.457.17**  
 17 cm/6<sup>3</sup>/<sub>4</sub>"

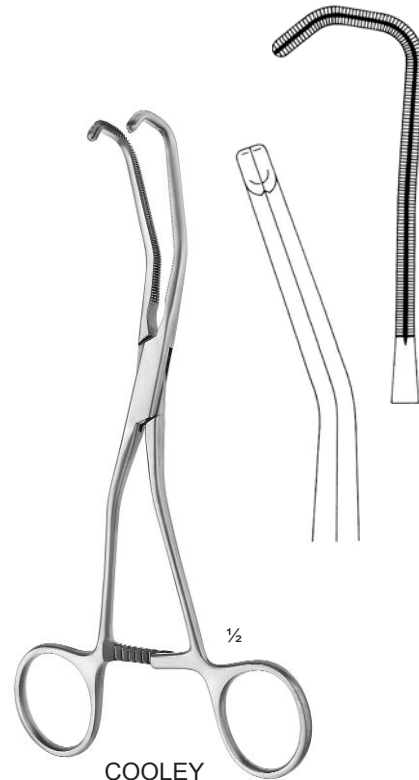

COOLEY  
**13.461.17**  
 17 cm/6<sup>3</sup>/<sub>4</sub>"

Carotis-Shuntklemmen  
 Carotid Shunt Clamps  
 Pincas pour carotide  
 Pincas para shunt carotido  
 Pinze carotis



COOLEY

**13.465.18**  
 18,5 cm/7<sup>1</sup>/<sub>4</sub>"

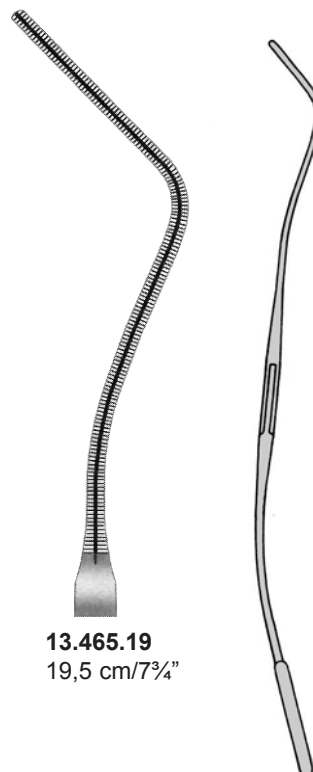

**13.465.19**  
 19,5 cm/7<sup>3</sup>/<sub>4</sub>"



Atraumatische Gefäßklappen  
Atraumatic Vascular Clamps  
Pincas vasculaires atraumatiques  
Pinzas vasculares atraumáticas  
Pinze vascolari atraumatiche

**dimed**<sup>®</sup>

SURGICAL INSTRUMENTS

**ATRAUMA**



COOLEY

Carotis-Shuntklappen  
Carotid Shunt Clamps  
Pincas pour carotide  
Pinzas para shunt carótido  
Pinze carotis

Atraumatische Mehrzweckklappen  
Atraumatic Multi-Purpose Clamps  
Pincas-clamps polyvalentes  
Pinzas clamps para usos varios  
Pinze atraumatiche per diversi usi



COOLEY  
**13.467.27**  
27,5 cm/10<sup>3</sup>/<sub>4</sub>"



COOLEY  
**13.465.26**  
26 cm/10<sup>1</sup>/<sub>4</sub>"

**ATRAUMA**

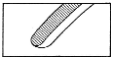

CASTAÑEDA

Neonatal- und Kinderklemmen, extra feine Modelle  
 Neonatal and Childrens Clamps, extra delicate patterns  
 Pincas-clamps pour des nouveaux-nés et des enfants, modèles très fins  
 Pinzas clamps para recién nacidos y niños, modelos muy finos  
 Pinze pediatriche, modelli molto fini

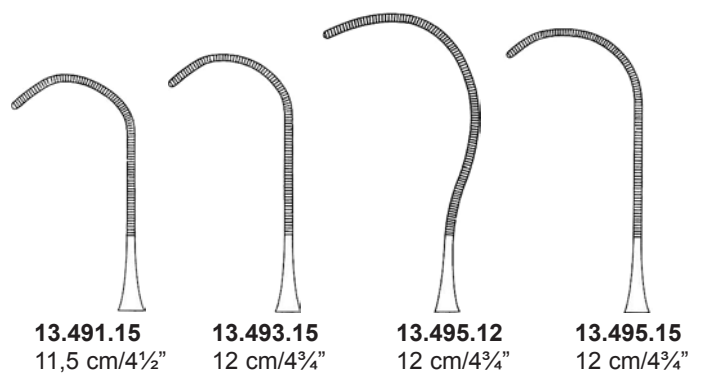
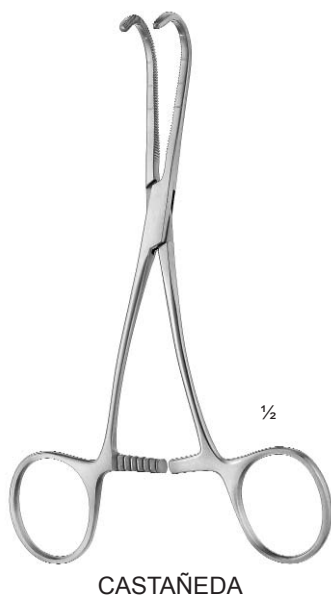
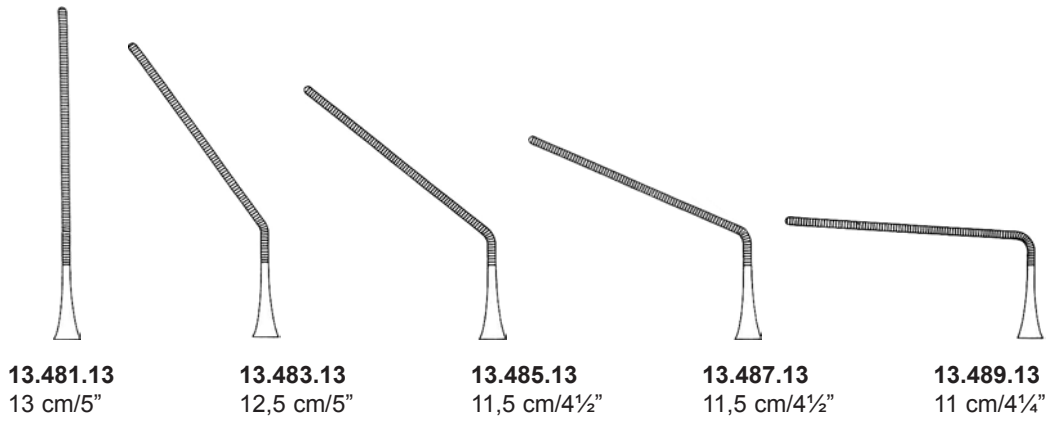

Atraumatische Gefäßklemmen  
 Atraumatic Vascular Clamps  
 Pincés vasculaires atraumatiques  
 Pinzas vasculares atraumáticas  
 Pinze vascolari atraumatiche

**dimedda**<sup>®</sup>

SURGICAL INSTRUMENTS

Neonatal- und Kinderklemmen, extra feine Modelle  
 Neonatal and Childrens Clamps, extra delicate patterns  
 Pincés-clamps pour des nouveaux-nés et des enfants, modèles très fins  
 Pinzas clamps para recién nacidos y niños, modelos muy finos  
 Pinze pediatriche, modelli molto fini

**ATRAUMA**



COOLEY



**13.505.01**  
14 cm/5 1/2"



**13.505.02**  
14 cm/5 1/2"



**13.505.03**  
14 cm/5 1/2"

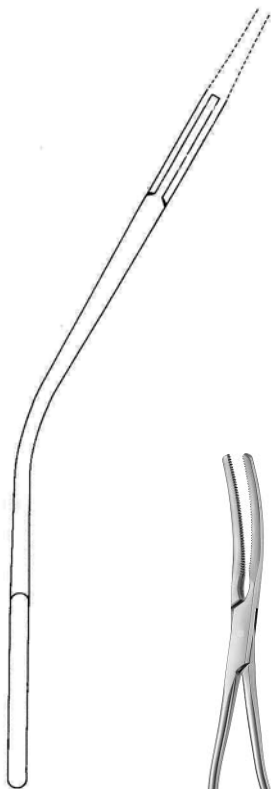

**13.505.04**  
13 cm/5"



**13.505.05**  
14 cm/5 1/2"



**13.505.06**  
13 cm/5"

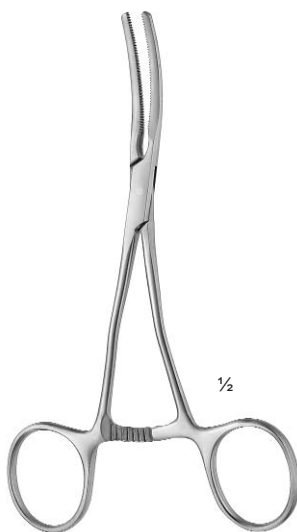

COOLEY



**13.505.07**  
13 cm/5"



**13.505.08**  
14 cm/5 1/2"



**13.505.09**  
13,5 cm/5 1/4"

**ATRAUMA**



COOLEY

Neonatal- und Kinderklemmen, extra feine Modelle  
 Neonatal and Childrens Clamps, extra delicate patterns  
 Pincès-clamps pour des nouveaux-nés et des enfants, modèles très fins  
 Pinzas clamps para recién nacidos y niños, modelos muy finos  
 Pinze pediatriche, modelli molto fini

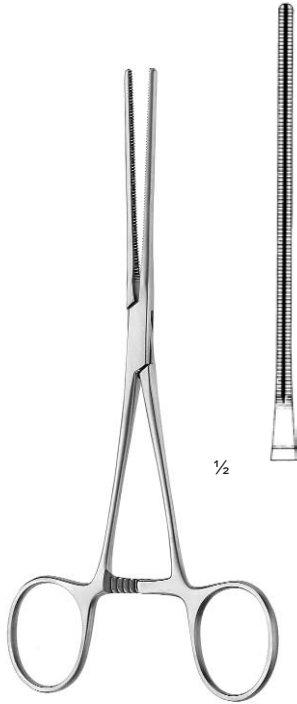

1/2

COOLEY  
**13.508.16**  
 16,5 cm/6 1/2"



1/2

COOLEY

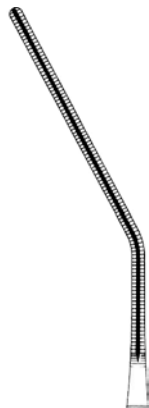

**13.509.16**  
 16 cm/6 1/4"

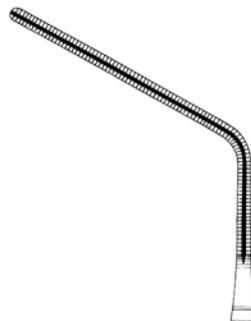

**13.510.16**  
 15,5 cm/6"

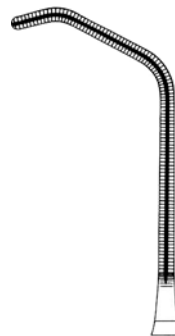

**13.511.15**  
 15,5 cm/6"

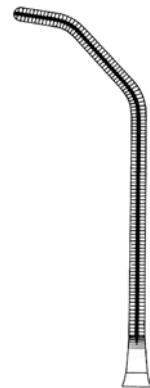

**13.512.16**  
 16 cm/6 1/4"

Atraumatische Gefäßklemmen  
Atraumatic Vascular Clamps  
Pinces vasculaires atraumatiques  
Pinzas vasculares atraumáticas  
Pinze vascolari atraumatiche

**dimeda**<sup>®</sup>

SURGICAL INSTRUMENTS

Neonatal- und Kinderklemmen, extra feine Modelle  
Neonatal and Childrens Clamps, extra delicate patterns  
Pinces-clamps pour des nouveaux-nés et des enfants, modèles très fins  
Pinzas clamps para recién nacidos y niños, modelos muy finos  
Pinze pediatriche, modelli molto fini

**ATRAUMA**



DE BAKEY

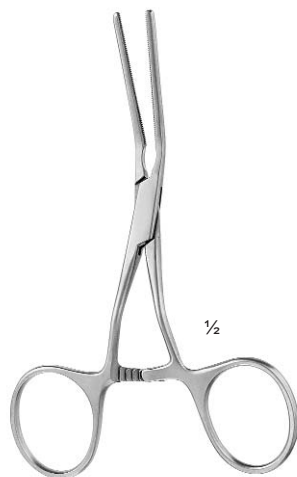

**CASTAÑEDA**  
12 cm/4<sup>3</sup>/<sub>4</sub>"

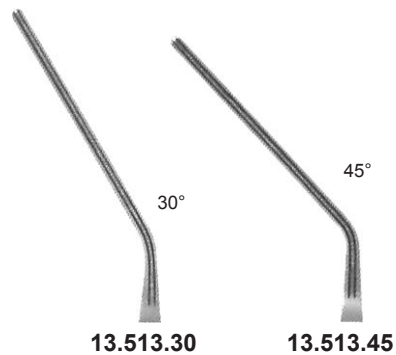

Atraumatische Gefäßklemmen  
Atraumatic Vascular Clamps  
Pinces vasculaires atraumatiques  
Pinzas vasculares atraumáticas  
Pinze vascolari atraumatiche

**dimed**<sup>®</sup>

SURGICAL INSTRUMENTS

**ATRAUMA**



DE BAKEY

Neonatal- und Kinderklemmen, extra feine Modelle  
Neonatal and Childrens Clamps, extra delicate patterns  
Pinces-clamps pour des nouveaux-nés et des enfants, modèles très fins  
Pinzas clamps para recién nacidos y niños, modelos muy finos  
Pinze pediatriche, modelli molto fini



**CASTAÑEDA**  
15,5 cm/6"



13.515.48

13.515.52

13.515.56

13.515.50



scharf  
sharp  
aigüe  
aguda  
acute

**SCHAEDDEL**  
**14.101.09**  
9 cm/3½"



scharf  
sharp  
aigüe  
aguda  
acute

**JONES**  
5,5 cm/2¼" **14.103.05**  
8,5 cm/3¼" **14.103.09**



scharf  
sharp  
aigüe  
aguda  
acute

mit Schlauchhalter  
with tube holder  
avec clamp porte-tube  
con porta-tubo

**JONES-CLIP**  
**14.105.09**  
8,5 cm/3¼"

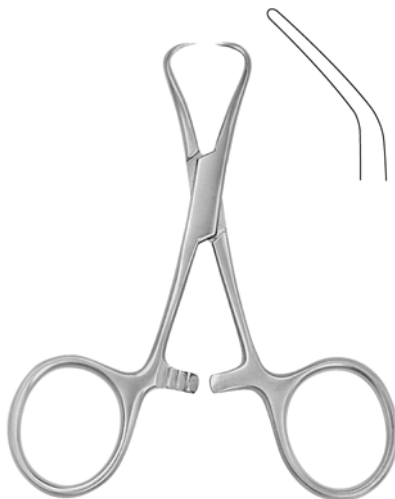

**BACKHAUS**  
9 cm/3½" **14.111.09**  
11 cm/4¼" **14.111.11**  
13 cm/5" **14.111.13**  
15 cm/6" **14.111.15**



**PEERS BERTRAM**  
**14.118.14**  
14,5 cm/5¾"

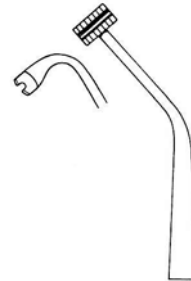

weites Maul zur Schlauchfixierung  
wide jaw for tube fixation  
mors large pour fixation de tube  
boca ancha para fijación de tubos  
morso spalancato per fissare il tubo

für Papierabdeckung  
for paper clothes  
pour couverture en papier  
para paños de papel  
per copertura di carta

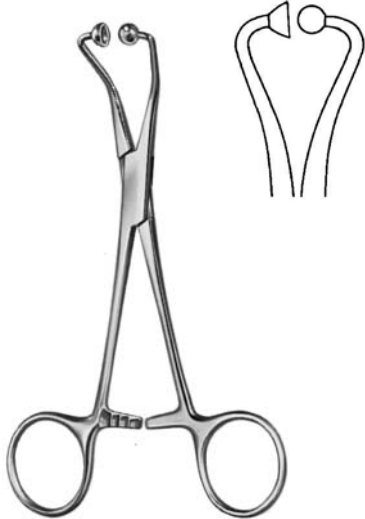

**BALL AND SOCKET**

9 cm/3½"	<b>14.123.09</b>
10 cm/4"	<b>14.123.10</b>
11 cm/4¼"	<b>14.123.11</b>
13 cm/5"	<b>14.123.13</b>
14 cm/5½"	<b>14.123.14</b>
16 cm/6¼"	<b>14.123.16</b>

stumpf  
blunt  
moussée  
roma  
smusse



**14.127.10**  
10 cm/4"

**14.127.13**  
13 cm/5"

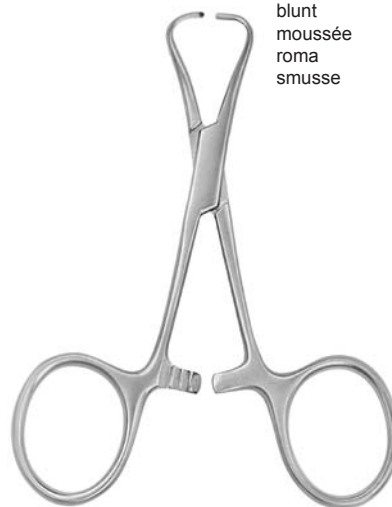

**TOHOKU**



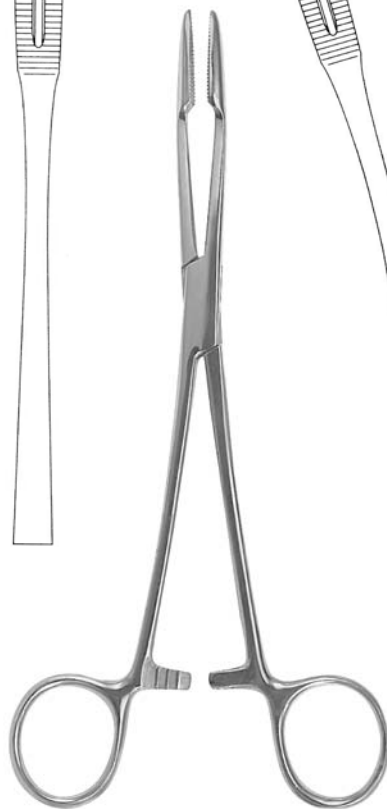
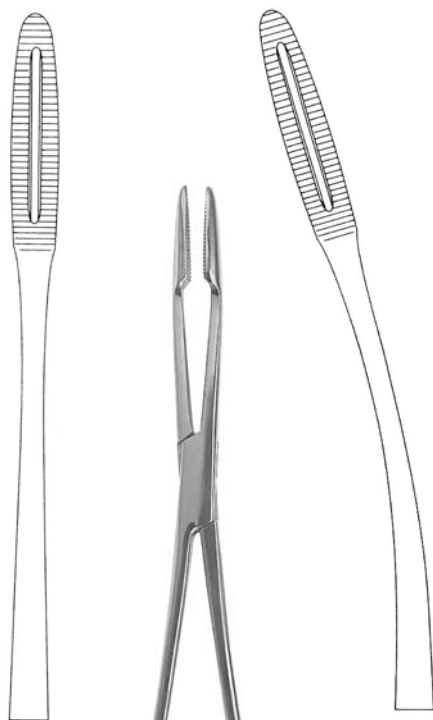

mit Sperre  
 with ratchet  
 avec crémaillère  
 con cremallera  
 con cremagliera

GROSS-MAIER

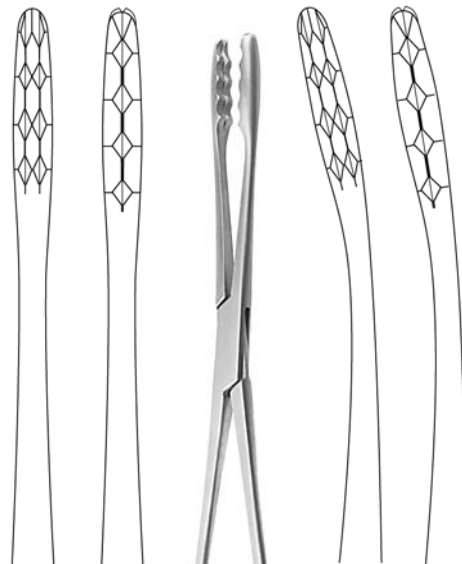

mit Sperre  
 with ratchet  
 avec crémaillère  
 con cremallera  
 con cremagliera

ULRICH

14 cm/5½"	<b>16.110.14</b>	<b>16.111.14</b>
18 cm/7"	<b>16.110.18</b>	<b>16.111.18</b>
20 cm/8"	<b>16.110.20</b>	<b>16.111.20</b>
22 cm/8¾"	<b>16.110.22</b>	<b>16.111.22</b>
25 cm/10"	<b>16.110.25</b>	<b>16.111.25</b>
27 cm/10½"	<b>16.110.27</b>	<b>16.111.27</b>
36 cm/14¼"	<b>16.110.36</b>	<b>16.111.36</b>
40 cm/16"	<b>16.110.40</b>	<b>16.111.40</b>

22 cm/8¾"	<b>16.160.22</b>	<b>16.161.22</b>
25 cm/10"	<b>16.160.25</b>	<b>16.161.25</b>
27 cm/10½"	<b>16.160.27</b>	<b>16.161.27</b>

Tupferzangen  
 Dressing Forceps  
 Pincès à pansements  
 Pinzas para tapones  
 Pinze per medicatura

**dimeda**<sup>®</sup>

SURGICAL INSTRUMENTS

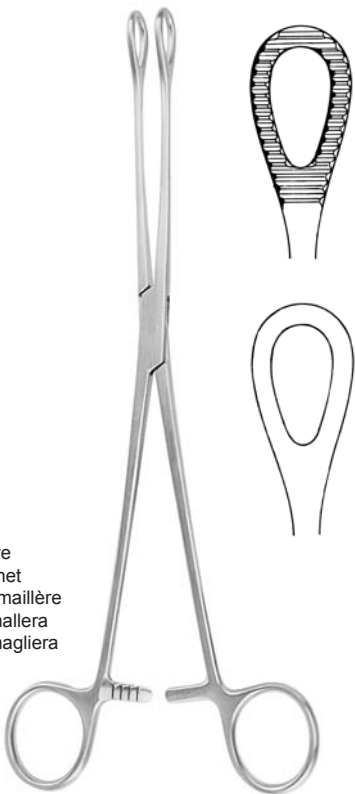

mit Sperre  
 with ratchet  
 avec crémaillère  
 con cremallera  
 con cremagliera

FOERSTER

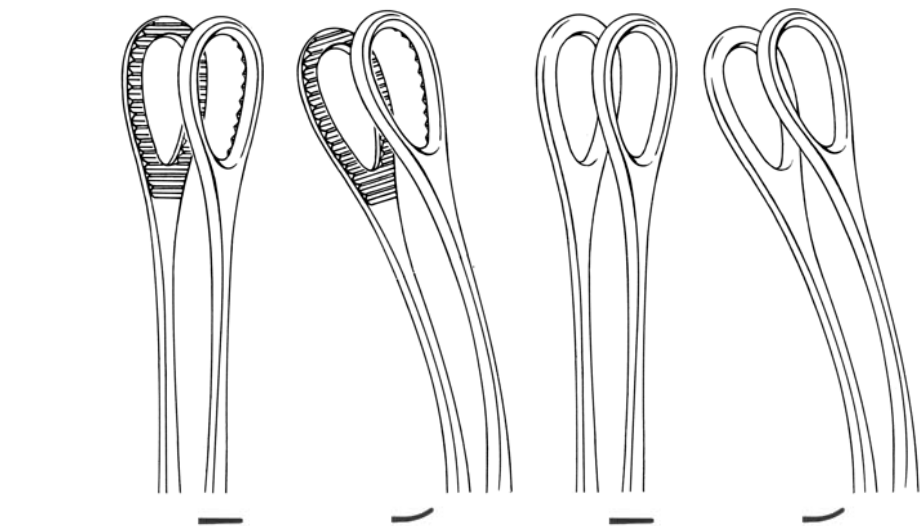

18 cm/7"	<b>16.170.18</b>	<b>16.171.18</b>	<b>16.172.18</b>	<b>16.173.18</b>
20 cm/8"	<b>16.170.20</b>	<b>16.171.20</b>	<b>16.172.20</b>	<b>16.173.20</b>
25 cm/10"	<b>16.170.25</b>	<b>16.171.25</b>	<b>16.172.25</b>	<b>16.173.25</b>
30 cm/12"	<b>16.170.30</b>	<b>16.171.30</b>	<b>16.172.30</b>	<b>16.173.30</b>

Sinusklemme  
 Sinus forceps  
 Pincès à sinus  
 Pinzas para seno  
 Pinze sinus

ohne Sperre  
 without ratchet  
 sans crémaillère  
 sin cremallera  
 senza cremagliera

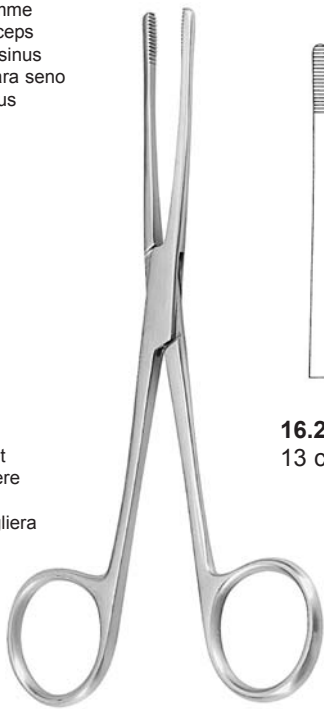

**LISTER**



**16.210.13**  
 13 cm/5"



**16.210.16**  
 16 cm/6¼"



**16.210.18**  
 18 cm/7"



**16.244.17**



**16.245.17**



**MARTIN**  
 17 cm/6¾"

mit Sperre  
 with ratchet  
 avec crémaillère  
 con cremallera  
 con cremagliera

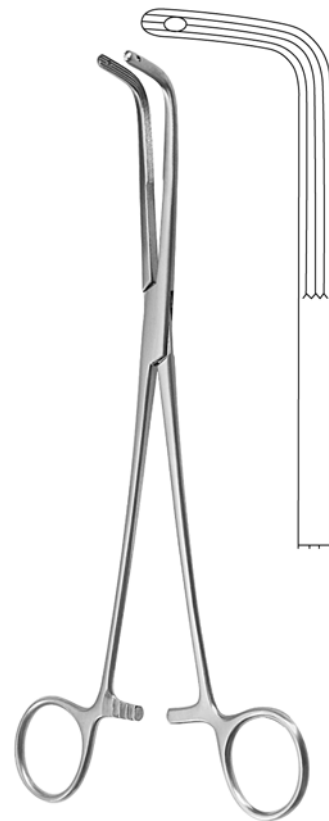
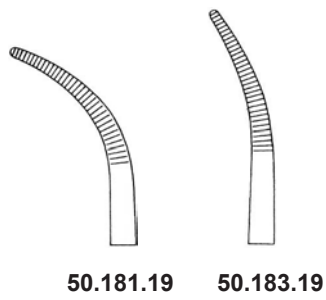

Lungenfaßzangen  
Lung Grasping Forceps  
Pincés à saisir le poumon  
Pinzas para coger el pulmón  
Pinze per afferrare il polmone

*dimeda*®

SURGICAL INSTRUMENTS



LOVELACE  
**56.290.20**  
20 cm/8"



LOVELACE  
**56.291.20**  
20 cm/8"



PRICE-THOMAS  
**56.309.22**  
22 cm/8<sup>3</sup>/<sub>4</sub>"

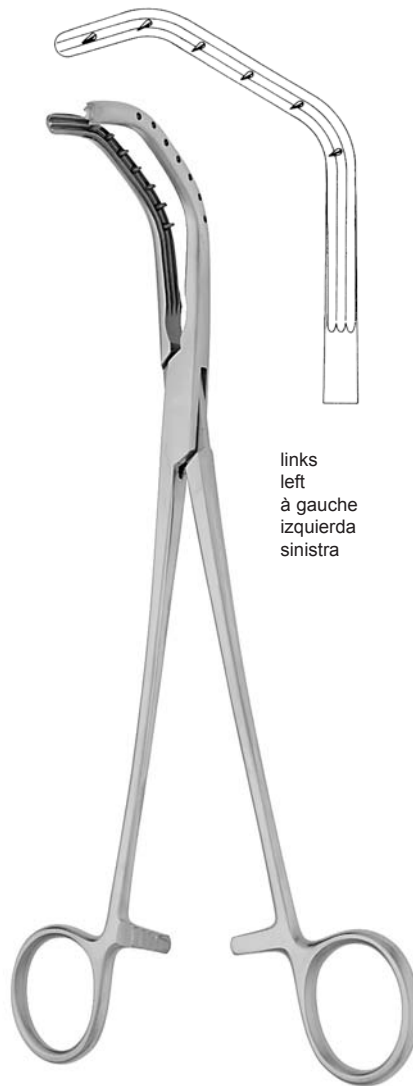

links  
left  
à gauche  
izquierda  
sinistra

PRICE-THOMAS  
**56.311.22**  
22 cm/8<sup>3</sup>/<sub>4</sub>"

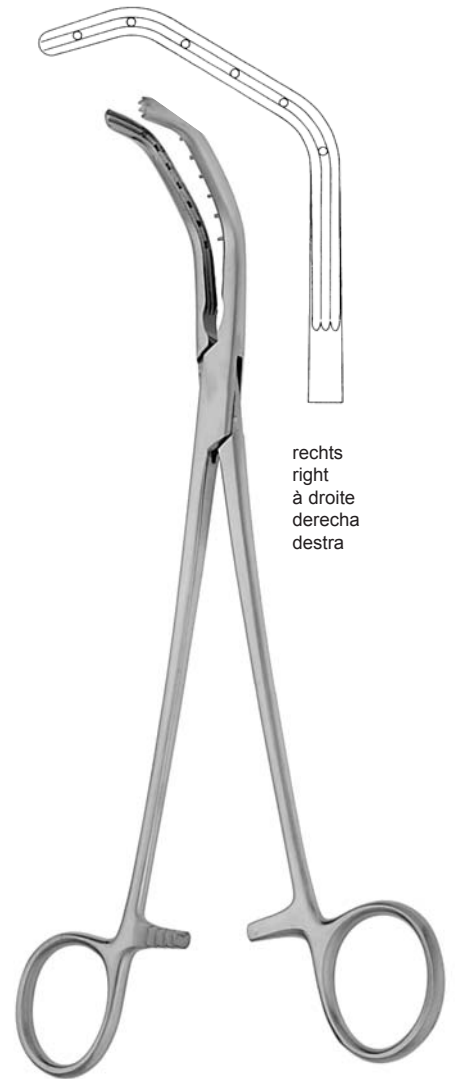

rechts  
right  
à droite  
derecha  
destra

PRICE-THOMAS  
**56.313.22**  
22 cm/8<sup>3</sup>/<sub>4</sub>"

Bronchusklemmen  
 Bronchus Forceps  
 Pincers-Clamps à Bronches  
 Pinzas clamps bronquiales  
 Pinze per bronchi

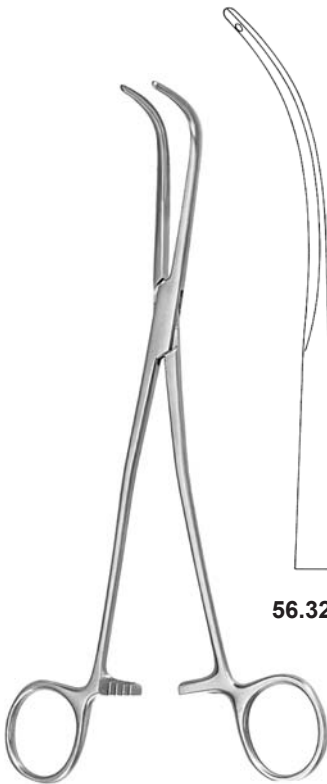

**56.321.23**

SEMB  
 23 cm/9"



**56.323.23**

Anastomosen- (Vena cava) Klemmen  
 Anastomosis (Vena Cava) Clamps  
 Pincers-clamps à anastomose (veine cave)  
 Pinzas clamps para anastomosis (vena cava)  
 Pinze per anastomosi (vena cava)

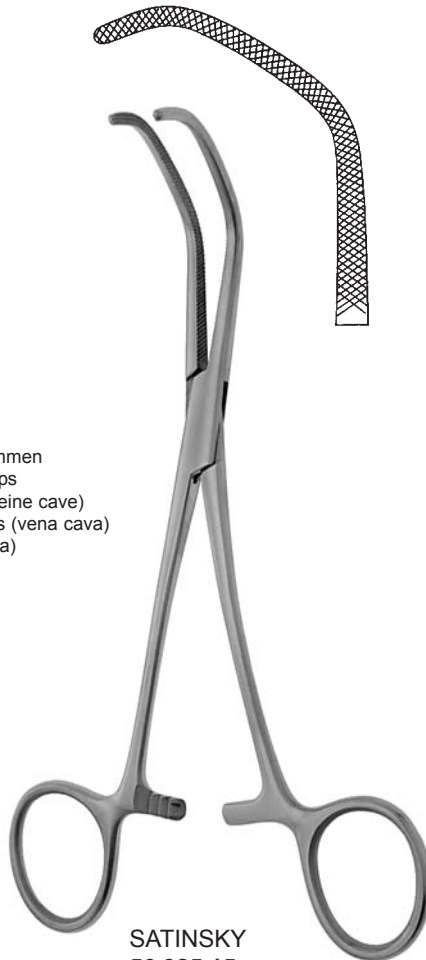

**SATINSKY**  
**56.325.15**  
 15 cm/6"



**BLAKE**  
**62.106.20**  
 21 cm/8¼"

Gallensteinzangen  
 Gall Stone Forceps  
 Pincers pour calculs biliaires  
 Pinzas para los cálculos biliares  
 Pinze per calcoli biliari

Darm- und Gewebefaßzangen  
 Bowel and Tissue Grasping Forceps  
 Pincès à saisir les intestins et les tissus  
 Pinzas para coger intestinos y tejidos  
 Pinze per afferrare intestini e tessuti

**dimed**<sup>®</sup>

SURGICAL INSTRUMENTS



ALLIS



4 : 5

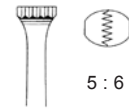

5 : 6

15 cm/6"	<b>64.110.15</b>
19 cm/7½"	<b>64.110.19</b>
25 cm/10"	<b>64.110.25</b>

15 cm/6"	<b>64.120.15</b>
19 cm/7½"	<b>64.120.19</b>
22 cm/8¾"	<b>64.120.22</b>
24 cm/9½"	<b>64.120.24</b>
30 cm/12"	<b>64.120.30</b>

**ATRAUMA**



DE BAKEY



ALLIS-Atrauma



**64.124.16**  
16 cm/6¼"



**64.124.20**  
20 cm/8"



**64.124.25**  
25 cm/10"



**64.124.30**  
30 cm/12"





BABCOCK



**64.160.16**  
16 cm/6¼"



**64.160.18**  
18 cm/7"



**64.160.20**  
20 cm/8"

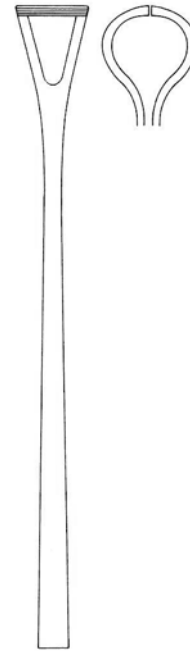

**64.160.24**  
24 cm/9½"

Mit TC-Einsätzen  
 TC Lined  
 A mors TC  
 Con bocas TC  
 Con morso TC



BABCOCK

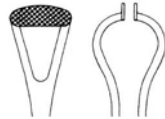

**64.164.16**  
16 cm/6¼"

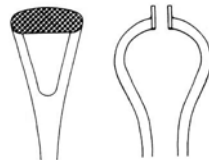

**64.164.20**  
20 cm/8"



**64.168.16**  
16 cm/6¼"



**64.168.20**  
20 cm/8"

**ATRAUMA**



DE BAKEY

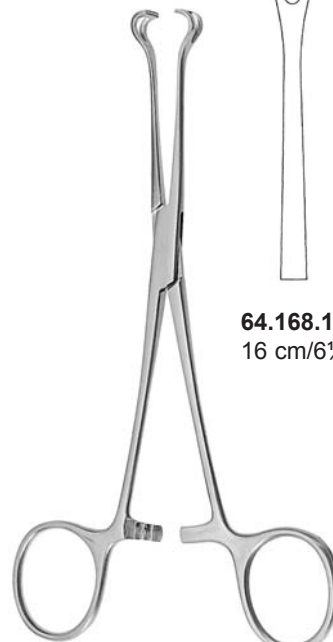

BABCOCK-Atrauma

Darm- und Gewebefäßzangen  
 Bowel and Tissue Grasping Forceps  
 Pincés à saisir les intestins et les tissus  
 Pinzas para coger intestinos y tejidos  
 Pinze per afferrare intestini e tessuti

**dimeda**®

SURGICAL INSTRUMENTS

**ATRAUMA**



DE BAKEY



Mit TC-Einsätzen  
 TC Lined  
 A mors TC  
 Con bocas TC  
 Con morso TC

DUVAL  
**64.174.20**  
 20 cm/8"



SCHEIBE

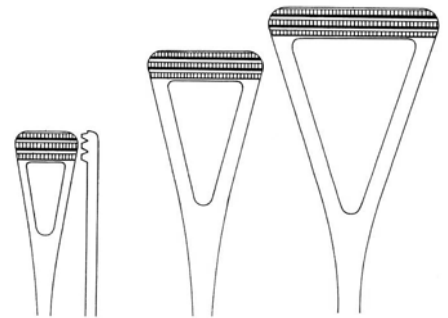

**64.178.18**  
 18 cm/7"

**64.178.20**  
 20 cm/8"

**64.178.23**  
 23 cm/9"



Wundhaken  
Retractors  
Ecarteurs  
Separadores  
Divaricatori

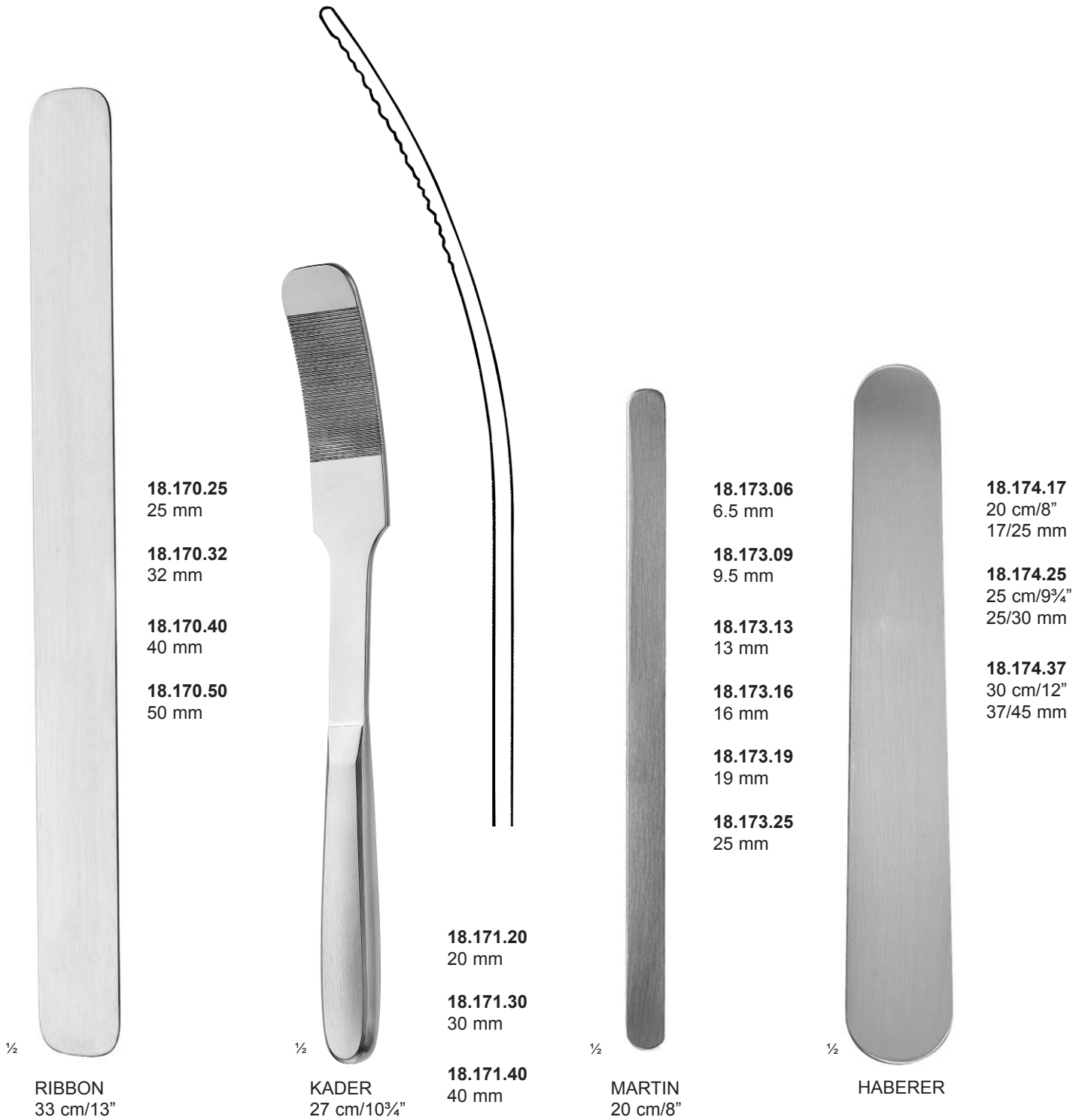

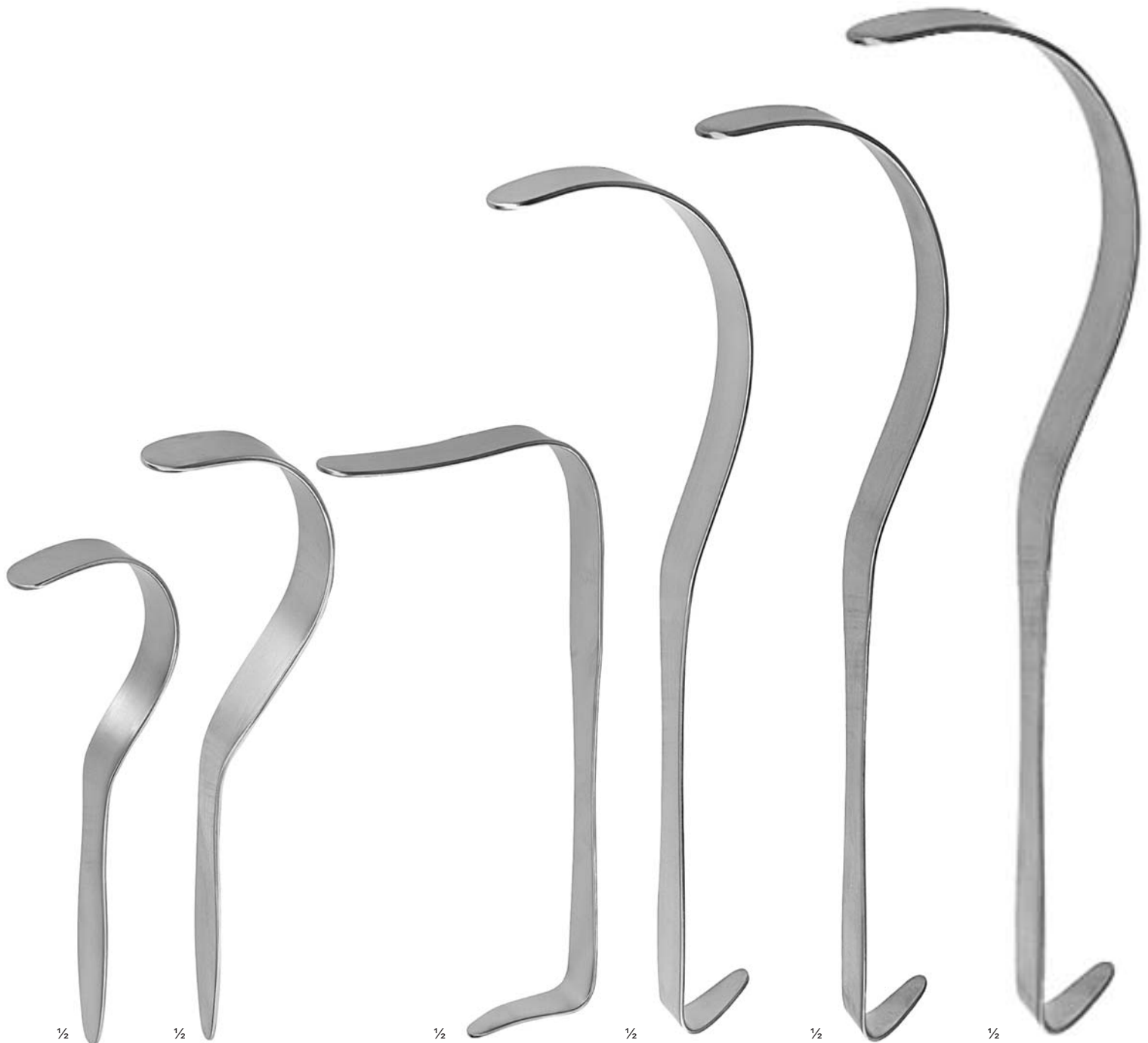

$\frac{1}{2}$   
DEAVER  
**18.180.19**  
18 cm/7"  
19 mm

$\frac{1}{2}$   
DEAVER  
**18.181.22**  
21,5 cm/8½"  
22 mm

$\frac{1}{2}$   
DEAVER  
**18.181.25**  
21,5 cm/8½"  
22 mm

$\frac{1}{2}$   
DEAVER  
**18.183.25**  
30 cm/12"  
25 mm

$\frac{1}{2}$   
DEAVER  
**18.185.25**  
33 cm/13"  
25 mm

$\frac{1}{2}$   
DEAVER  
**18.187.25**  
36 cm/14"  
25 mm

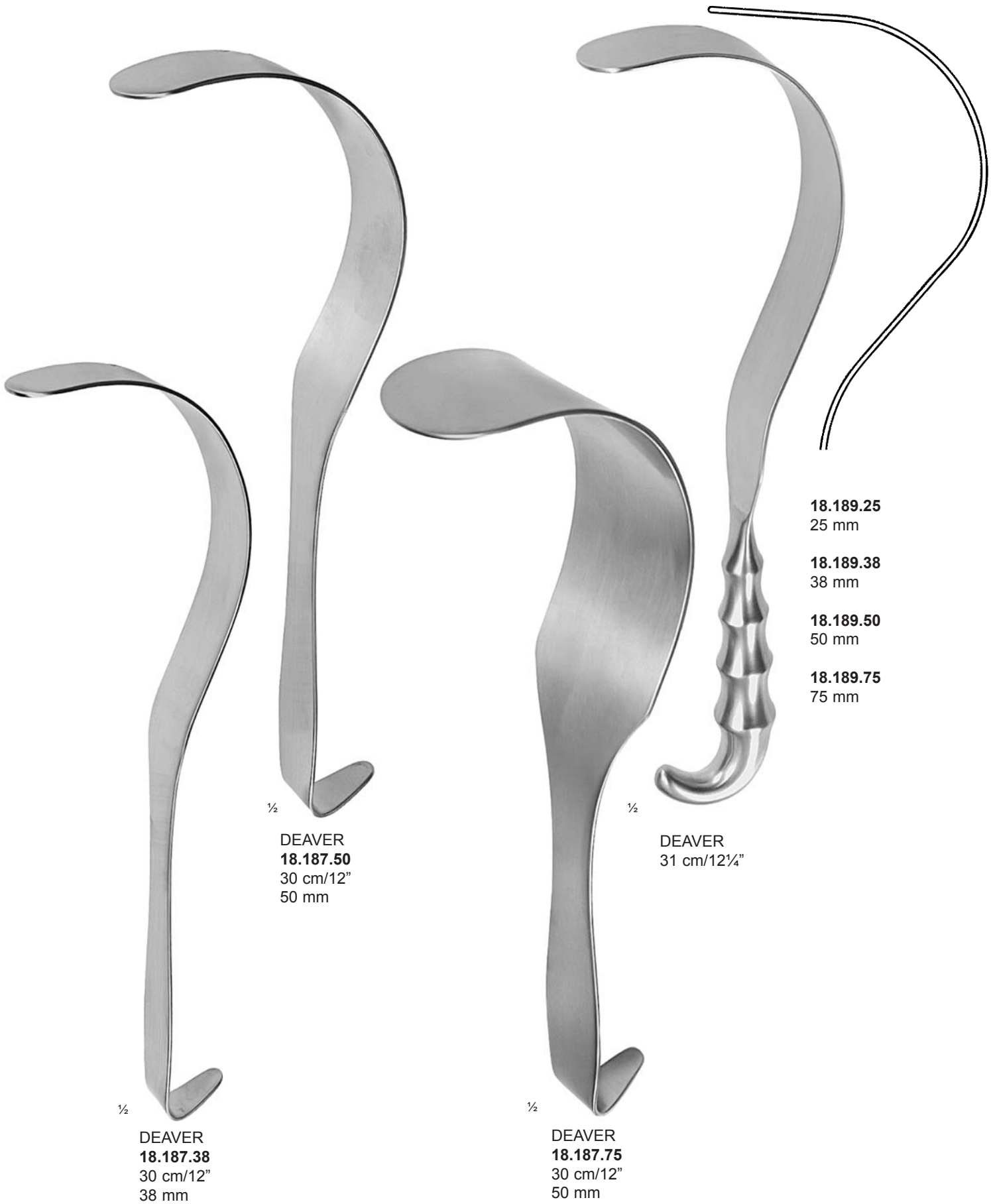

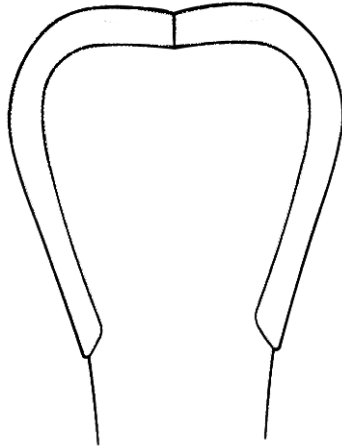

**18.191.40**  
123x45 mm

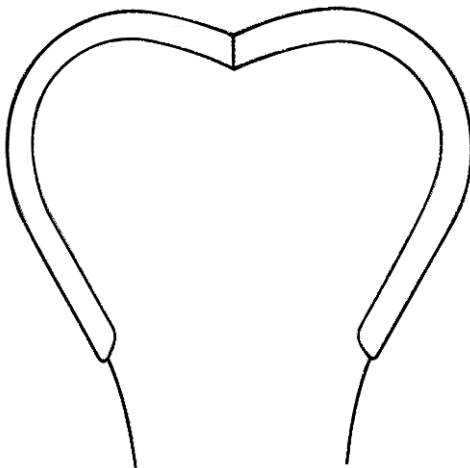

**18.191.62**  
123x64 mm

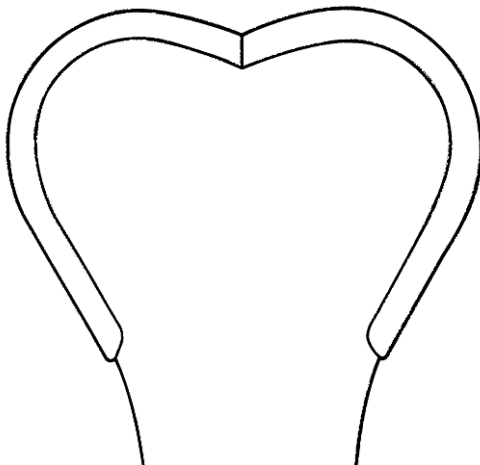

**18.191.64**  
175x64 mm



½

**HARRINGTON**  
29,5 cm/11½"







½

**VOLKMANN**  
**18.282.01**  
 21,5 cm/8½"



½

**VOLKMANN**  
**18.283.01**  
 21,5 cm/8½"



½

**VOLKMANN**  
**18.283.03**  
 21,5 cm/8½"



½

**LANGENBECK**  
 22 cm/8¾"

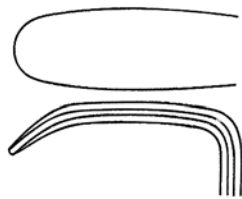

**18.312.01**  
 30x11 mm

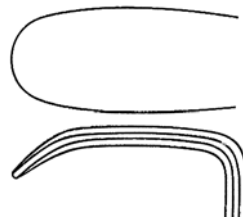

**18.312.02**  
 30x14 mm

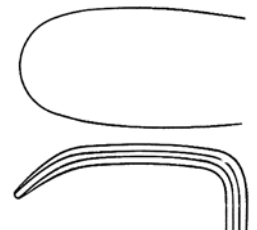

**18.312.03**  
 30x16 mm

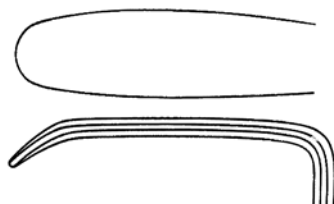

**18.312.04**  
 40x11 mm

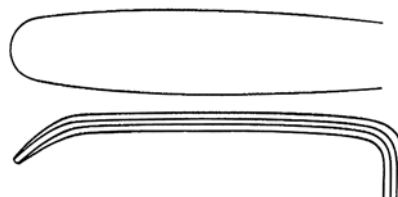

**18.312.05**  
 50x11 mm

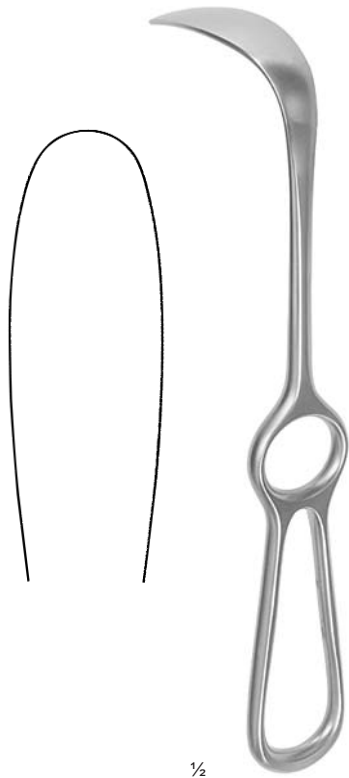

½  
**LANGENBECK**



**18.315.21**  
 21 cm/8¼"  
 63x20 mm

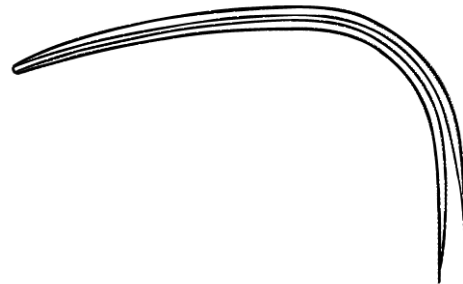

**18.315.22**  
 22 cm/8¾"  
 55x20 mm



½  
**KOENIG**  
 18 cm/7"



**18.318.82**  
 13x13 mm



**18.318.83**  
 12x16 mm



½  
**KOCHER**  
 19 cm/7½"



**18.332.19**  
 19x12 mm



**18.332.21**  
 21x14 mm



½  
**CUSHING-KOCHER**  
**18.341.18**  
 17,5 cm/7"  
 10x10 mm



KOCHER-LANGENBECK  
22 cm/8½"

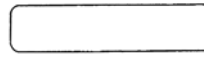

**18.342.01**  
25x6 mm

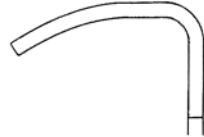

**18.342.04**  
35x15 mm

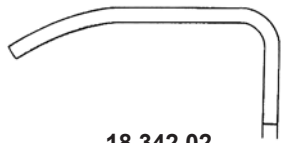

**18.342.02**  
35x8 mm

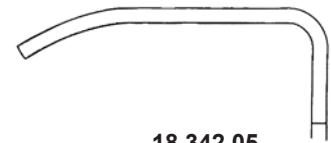

**18.342.05**  
40x11 mm



**18.342.03**  
35x11 mm

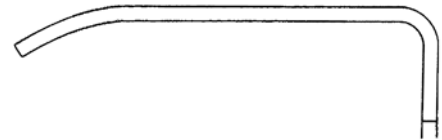

**18.342.06**  
55x11 mm

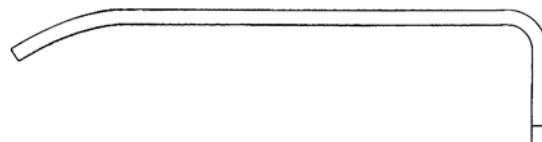

**18.342.07**  
70x14 mm

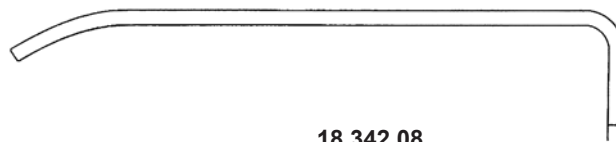

**18.342.08**  
80x12 mm



**18.342.09**  
80x16 mm

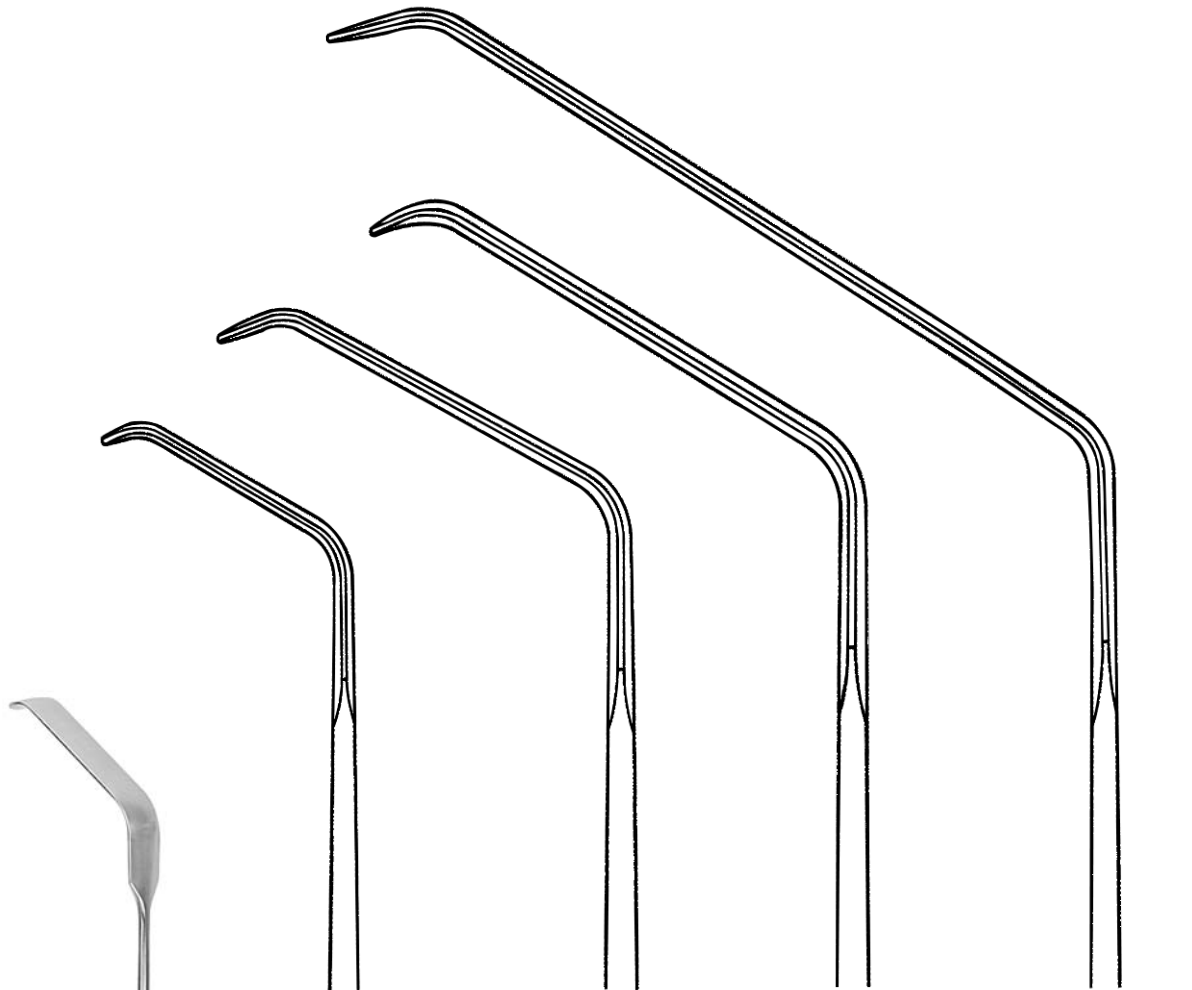

**18.343.35**  
24 cm/9½"  
36x8 mm

**18.343.60**  
25,5 cm/10½"  
60x12 mm

**18.343.75**  
17 cm/10¾"  
75x12 mm

**18.343.12**  
29 cm/11½"  
120x12 mm

½

ZENKER

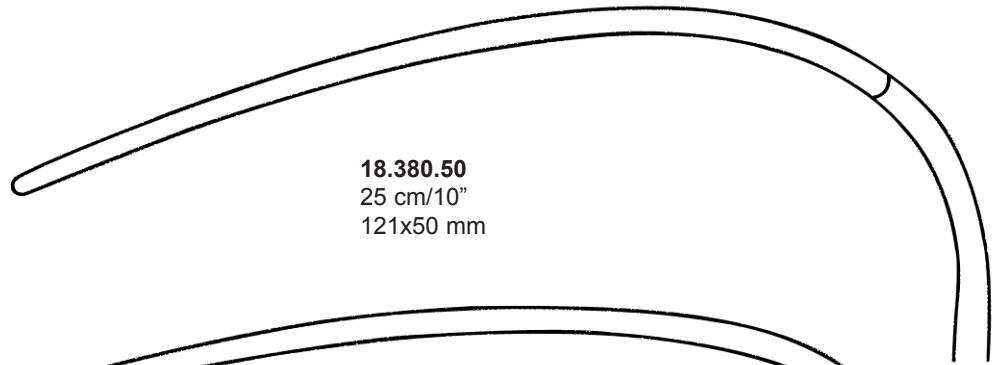

**18.380.50**  
25 cm/10"  
121x50 mm

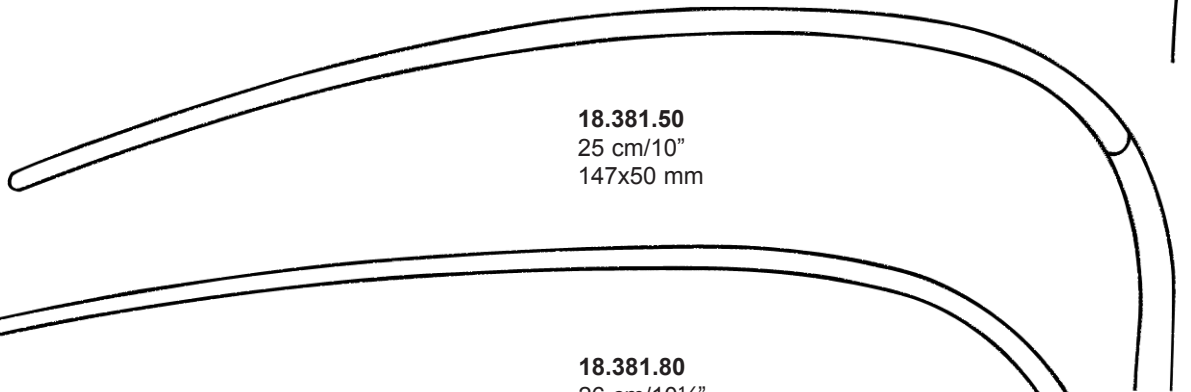

**18.381.50**  
25 cm/10"  
147x50 mm

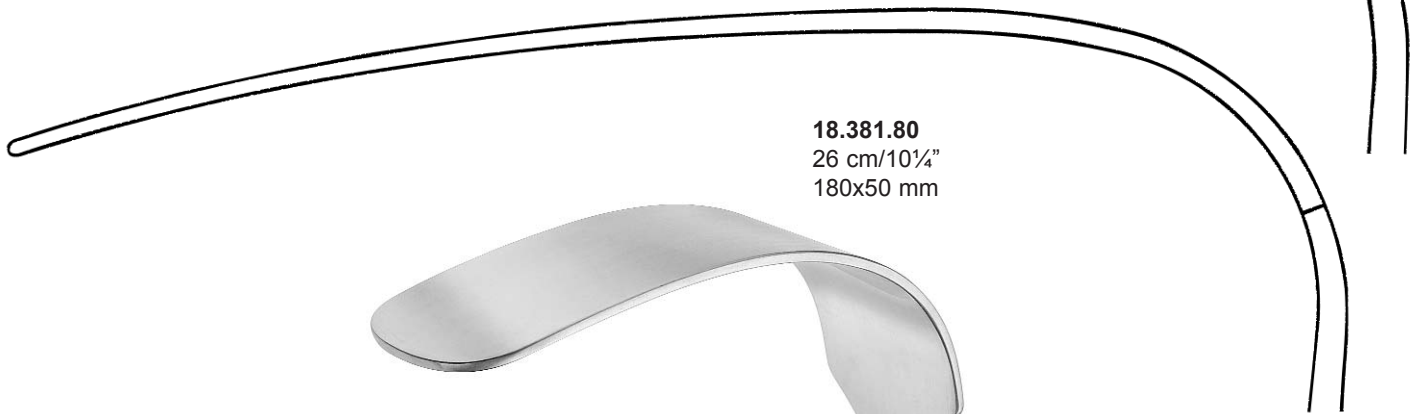

**18.381.80**  
26 cm/10<sup>1</sup>/<sub>4</sub>"  
180x50 mm

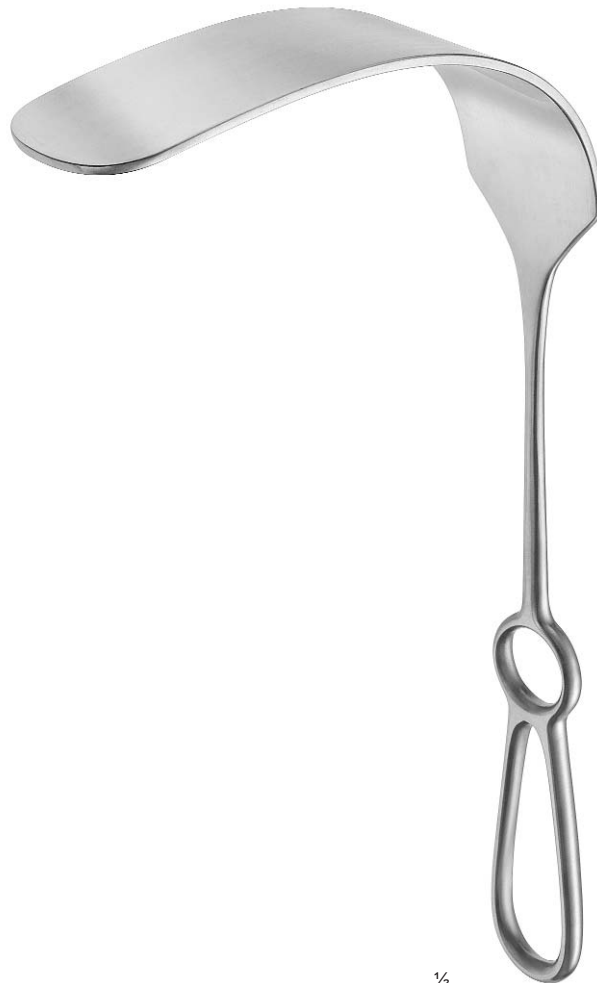

½

MIKULICZ

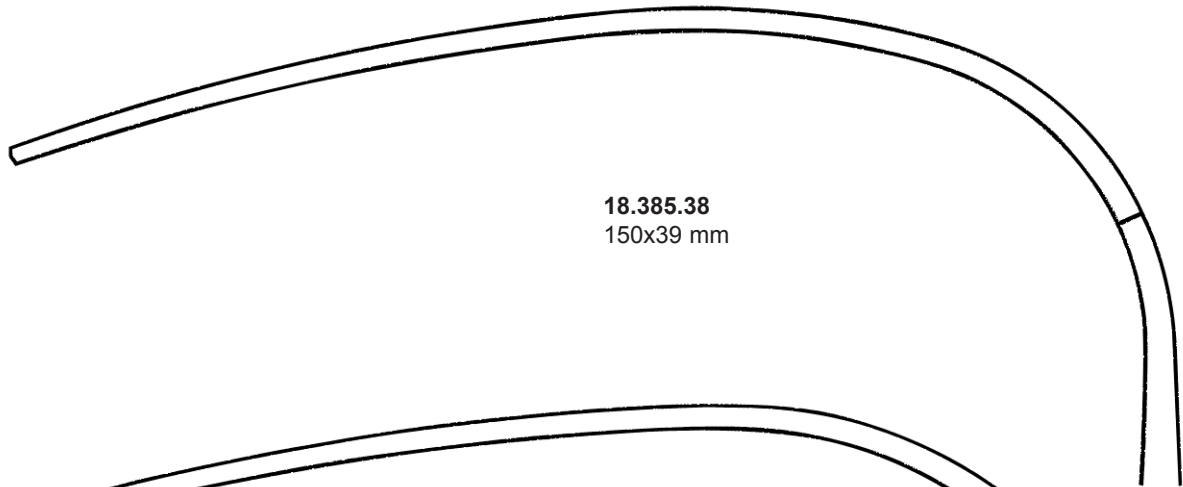

**18.385.38**  
150x39 mm



**18.385.57**  
155x57 mm

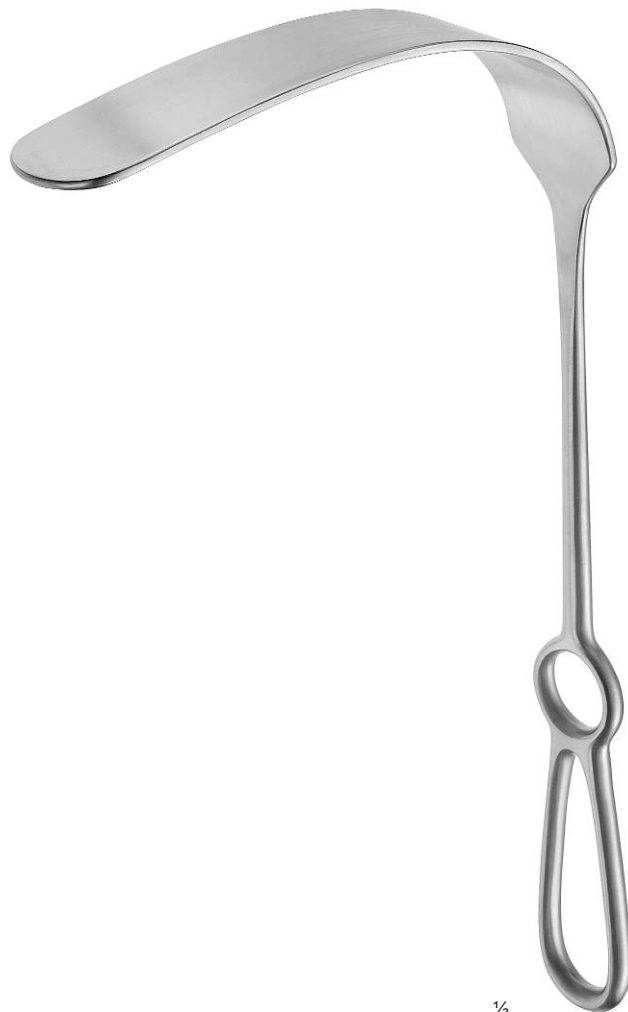

½

**KELLY**  
26 cm/10¼"

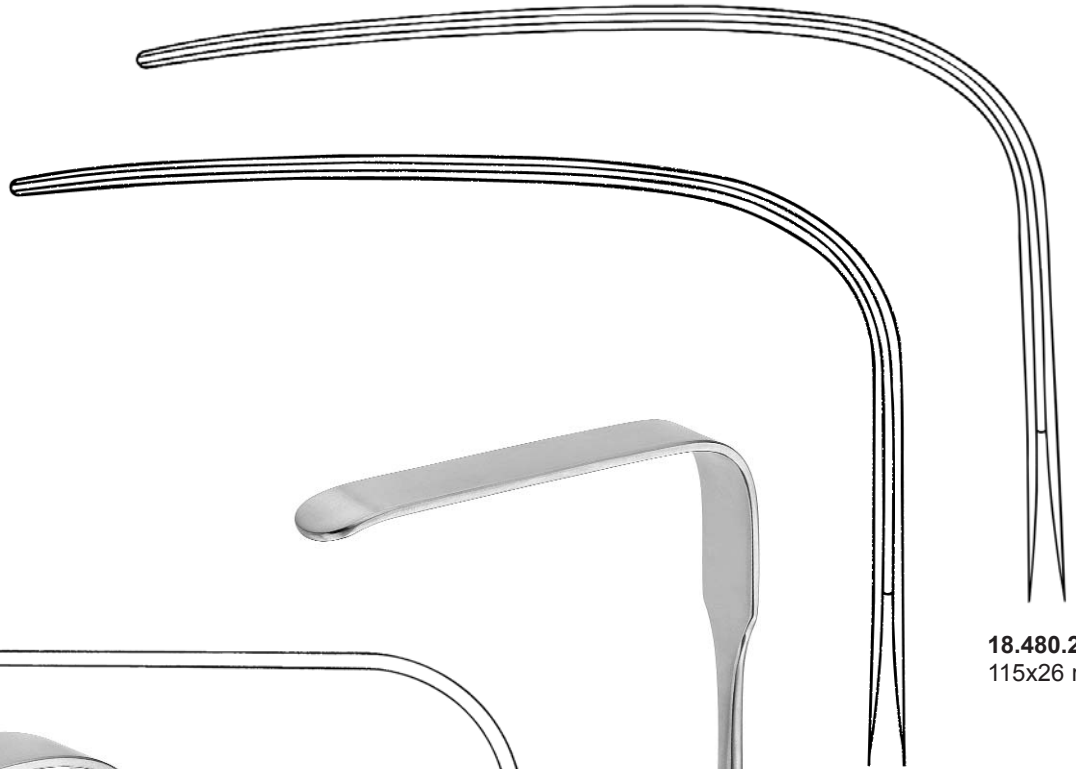

**18.480.27**  
115x26 mm

**18.480.22**  
115x22 mm



$\frac{1}{2}$   
**MARTIN**  
**18.398.25**  
25 cm/10"  
105x27 mm

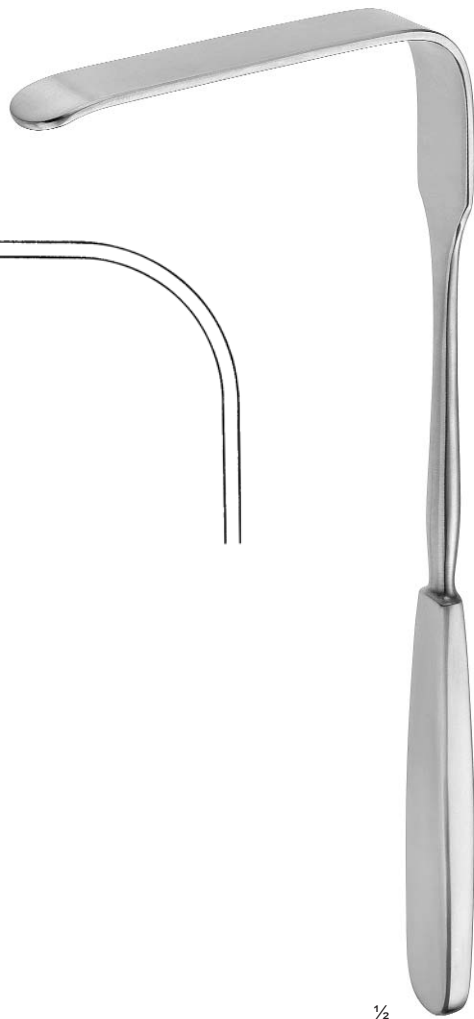

$\frac{1}{2}$   
**SIMON**  
27 cm/10 $\frac{3}{4}$ "



**18.490.22**  
85x22 mm



**18.490.43**  
108x43 mm



**18.490.65**  
119x65 mm

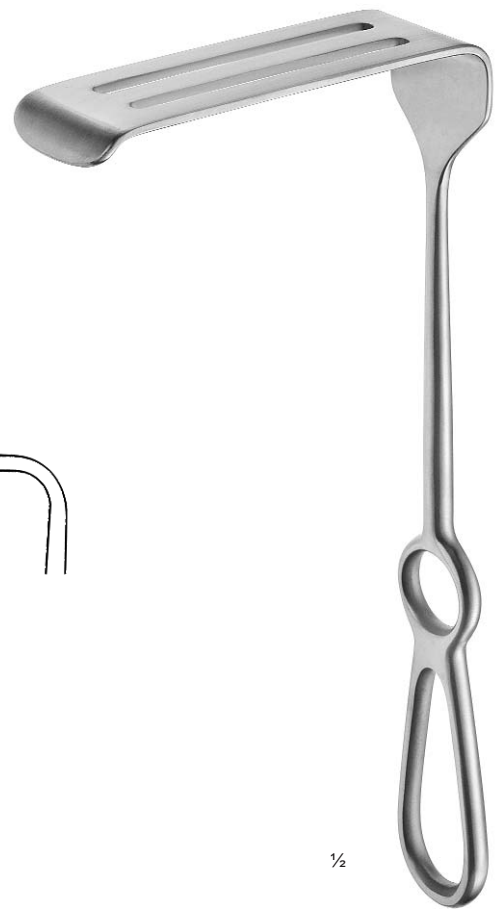

**CORYLLOS**  
25,5 cm/10"





½

SAUERBRUCH  
**18.492.25**  
26 cm/10¼"  
130x38 mm

DAVIDSON  
**18.496.90**  
19,5 cm/7¾"  
74x92 mm



1/2

ALM

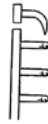

**18.620.07**  
 7 cm/2 3/4"

scharf  
 sharp  
 pointu  
 agudo  
 acuto

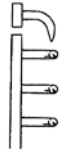

**18.620.10**  
 10 cm/4"

scharf  
 sharp  
 pointu  
 agudo  
 acuto

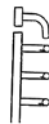

**18.621.07**  
 7 cm/2 3/4"

stumpf  
 blunt  
 mousse  
 romo  
 smusso

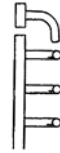

**18.621.10**  
 10 cm/4"

stumpf  
 blunt  
 mousse  
 romo  
 smusso



1/2

ALLPORT  
**18.624.10**  
 9,5 cm/3 3/4"

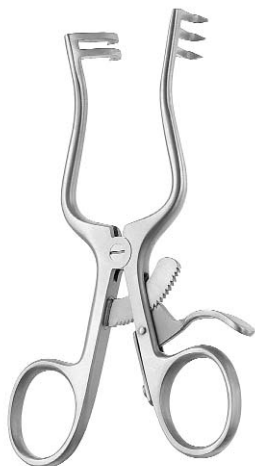

1/2

WEITLANER

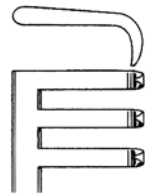

**18.650.10**  
 11,5 cm/4 1/2"  
 2 : 3

scharf  
 sharp  
 pointu  
 agudo  
 acuto

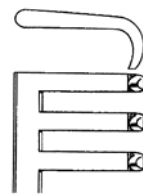

**18.651.10**  
 11,5 cm/4 1/2"  
 2 : 3

stumpf  
 blunt  
 mousse  
 romo  
 smusso

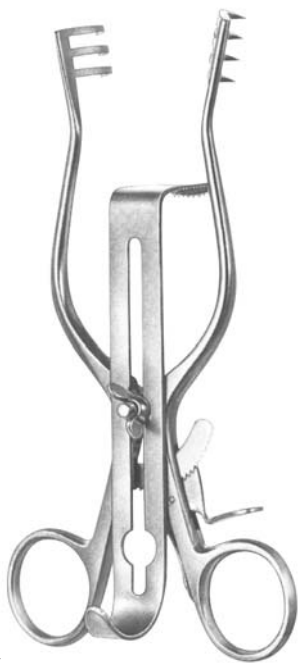

1/2

**HENLEY**  
 16,5 cm/6 1/2"

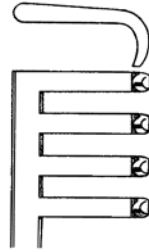

**18.660.16**  
 3 : 4

stumpf  
 blunt  
 mousse  
 romo  
 smusso

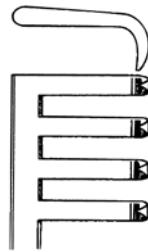

**18.661.16**  
 3 : 4

scharf  
 sharp  
 pointu  
 agudo  
 acuto

mit Mittelvalven  
 18.661.17 - 18.661.19

with Central Blades  
 18.661.17 - 18.661.19

avec lames centrls  
 18.661.17 - 18.661.19

con valvas centrales  
 18.661.17 - 18.661.19

con lamierine centrali  
 18.661.17 - 18.661.19



1/2

**18.661.17**  
 16x19 mm  
 5/8" x 3/4"



1/2

**18.661.18**  
 16X25 mm  
 5/8" x 1"



1/2

**18.661.19**  
 16x32 mm  
 5/8" x 1 1/4"



1/2

**WEITLANER**

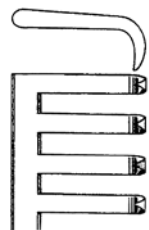

**18.670.14**  
 13 cm/4 1/4"  
 3 : 4

scharf  
 sharp  
 pointu  
 agudo  
 acuto

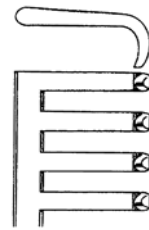

**18.671.14**  
 13 cm/4 1/4"  
 3 : 4

stumpf  
 blunt  
 mousse  
 romo  
 smusso

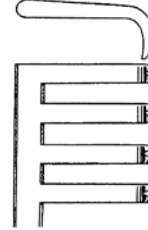

**18.670.16**  
 16,5 cm 6 1/2"  
 3 : 4

scharf  
 sharp  
 pointu  
 agudo  
 acuto

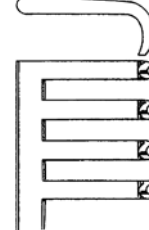

**18.671.16**  
 16,5 cm 6 1/2"  
 3 : 4

stumpf  
 blunt  
 mousse  
 romo  
 smusso

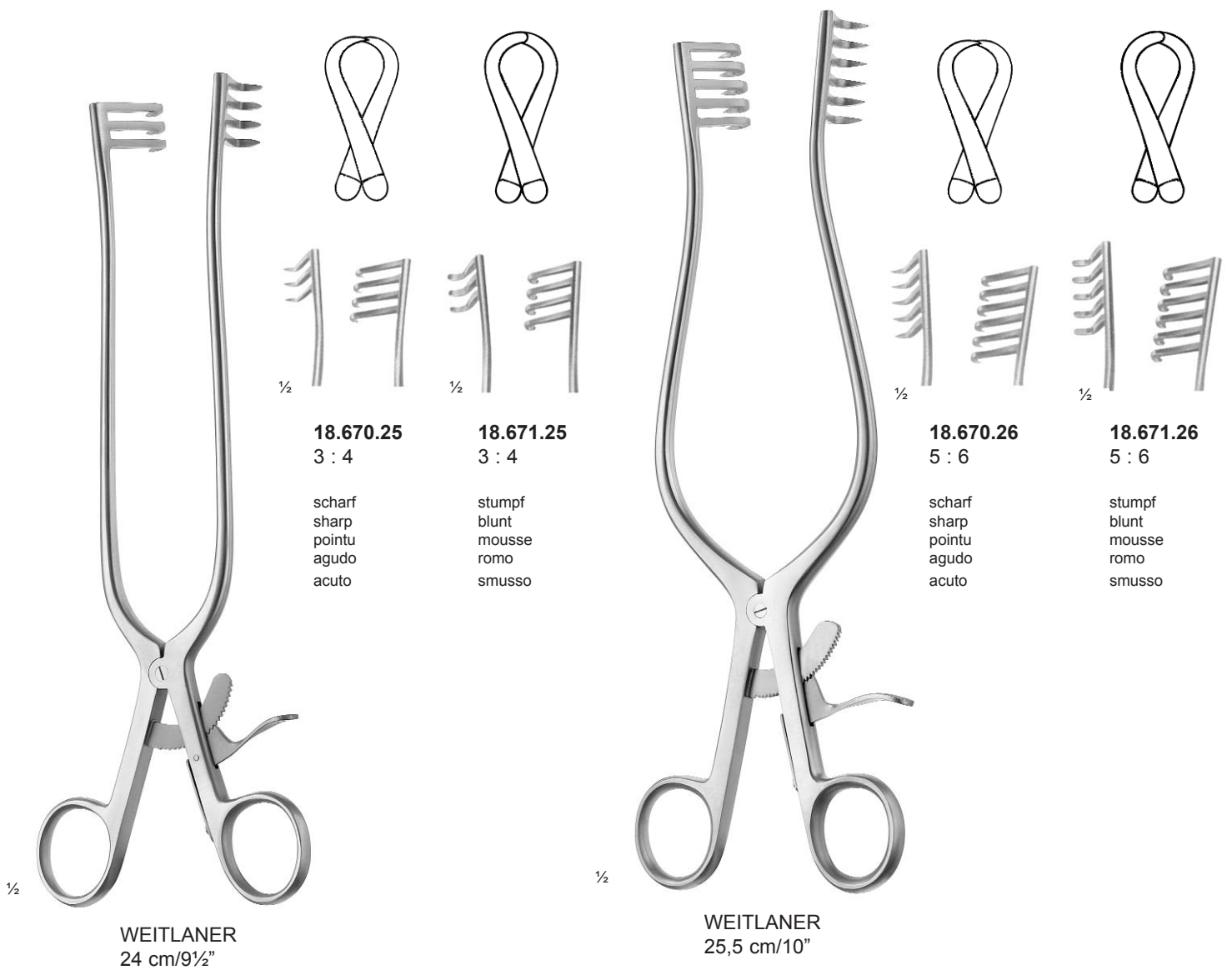



1/2

**WEITLANER**  
 20 cm/8"

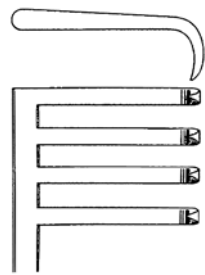

**18.670.20**  
 3 : 4

scharf  
 sharp  
 pointu  
 agudo  
 acuto

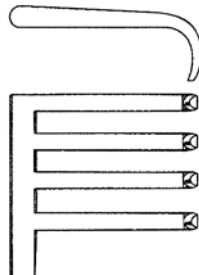

**18.671.20**  
 3 : 4

stumpf  
 blunt  
 mousse  
 romo  
 smusso



1/2

**ADSON-BABY**  
 14 cm/5½"

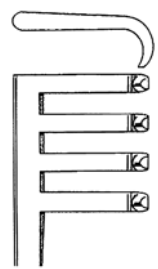

**18.684.16**  
 3 : 4

scharf  
 sharp  
 pointu  
 agudo  
 acuto

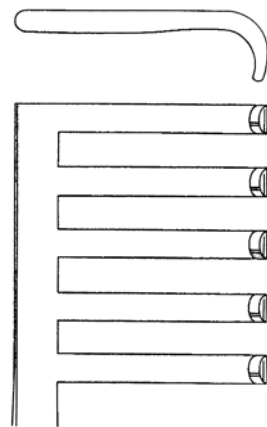
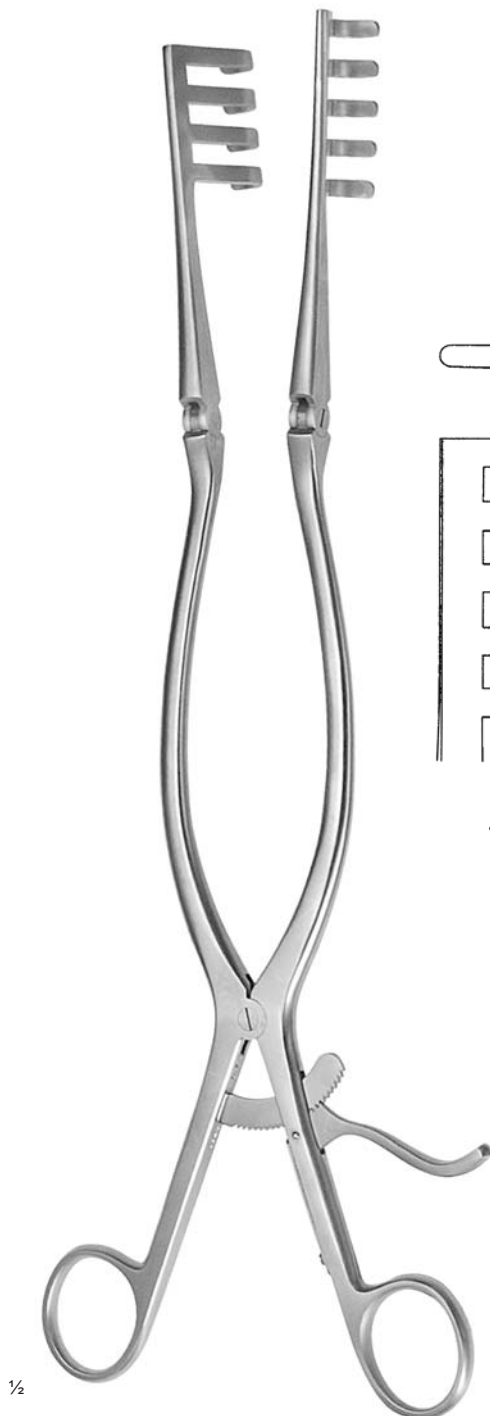

4 : 5

stumpf  
 blunt  
 mousse  
 romo  
 smusso

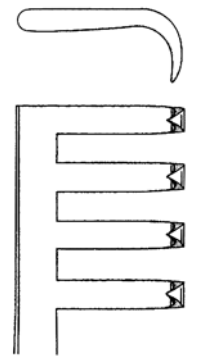

4 : 4

scharf  
 sharp  
 pointu  
 agudo  
 acuto

BECKMANN-ADSON  
**18.686.32**  
 32 cm/12<sup>3</sup>/<sub>4</sub>"

BECKMANN  
**18.690.31**  
 31 cm/30<sup>1</sup>/<sub>2</sub>"



**SELLORS**  
**56.280.19**  
20 cm/8"

Rippensperrer und-Kontraktor  
mit drehbaren

Rib spreader and contractor  
with swivel blades

Ecarteur et rapprocheur des côtes  
avec valves orientables

Separador y contractor costal  
con garras girables

Divaricatore ed approssimatore costale  
con valve orientabili



**BAILEY-BABY**  
**56.282.14**  
15,5 cm/6"



**BAILEY**  
**56.284.16**  
20 cm/8"

für Kinder  
for children  
pour enfants  
para niños  
per bambini



**BAILEY-GIBBON**  
**56.286.16**  
20 cm/8"

für Erwachsene  
for adults  
pour adultes  
para adultos  
per adulti

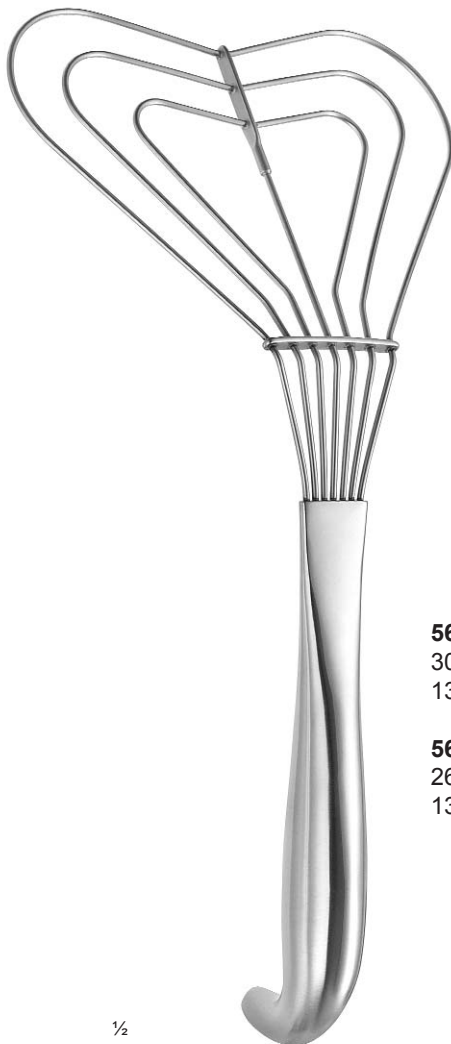

**56.288.30**  
30 cm/12"  
137 mm

**56.289.26**  
26 cm/10<sup>1</sup>/<sub>4</sub>"  
132 mm



**56.289.28**  
28 cm/11"  
30 mm

**56.289.30**  
30 cm/12"  
40 mm

**56.289.31**  
32 cm/12<sup>3</sup>/<sub>4</sub>"  
54 mm

**56.289.32**  
32 cm/12<sup>3</sup>/<sub>4</sub>"  
65 mm

ALLISON





½

COOLEY  
**56.293.01**  
25 cm/9¾"  
48x48 mm

rechts  
right  
droite  
derecho  
destro



½

COOLEY  
**56.293.02**  
25 cm/9¾"  
48x48 mm

rechts, gerieft  
right, serrated  
droite, cannelé  
derecho, estriado  
destro, seghettato



½

COOLEY  
**56.293.03**  
27,5 cm/10¾"  
30x48 mm

links  
left  
gauche  
izquierdo  
sinistro



$\frac{1}{2}$

COOLEY modif. STRUCK  
**56.293.04**  
25 cm/9 $\frac{3}{4}$ "  
45x35 mm

gerieft  
serrated  
cannelé  
estriado  
seghettato



$\frac{1}{2}$

COOLEY modif. STRUCK  
**56.293.05**  
25 cm/9 $\frac{3}{4}$ "  
45x30 mm

gerieft  
serrated  
cannelé  
estriado  
seghettato



½

**BOROWSKI**  
27 cm/10¾"



**56.295.01**  
17x21 mm



**56.295.04**  
24x27 mm



**56.295.02**  
16x23 mm

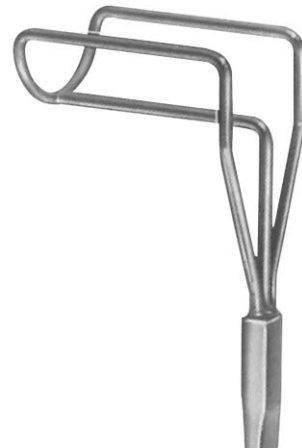

**56.295.05**  
28x20 mm



**56.295.03**  
20x25 mm



**56.295.06**  
28x29 mm

*dimeda*<sup>®</sup>

SURGICAL INSTRUMENTS



Nadelhalter  
Needle Holders  
Porte-aiguilles  
Porta-agujas  
Port'aghi

Mit TC-Einsätzen  
TC Lined  
A mors TC  
Con bocas TC  
Con morso TC



1/2

HALSEY  
**24.144.13**  
13 cm/5 1/4"



1/2

CRILE-WOOD  
**24.164.15**  
14,5 cm/5 3/4"



1/2

BABY-CRILE-WOOD  
**24.168.15**  
15 cm/6"

Mit TC-Einsätzen  
 TC Lined  
 A mors TC  
 Con bocas TC  
 Con morso TC



½

MAYO-HEGAR

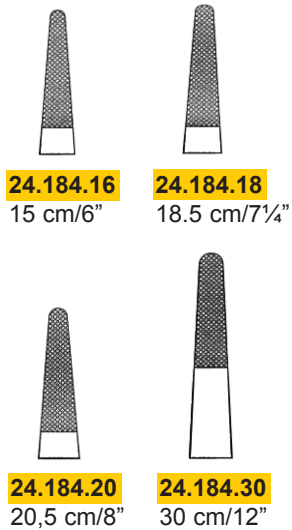

½

DE BAKEY

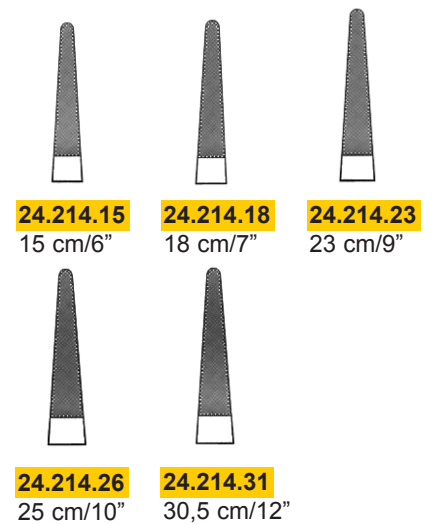

Mit TC-Einsätzen  
TC Lined  
A mors TC  
Con bocas TC  
Con morso TC



1/2



**24.216.18**  
18 cm/7"



**24.216.21**  
20 cm/8"



**24.216.23**  
23 cm/9"

schlankes Modell  
delicate pattern  
modèle gracile  
modelo delgado  
modello fino



1/3

DE BAKEY  
**24.216.31**  
30,5 cm/12"

schlankes Modell  
delicate pattern  
modèle gracile  
modelo delgado  
modello fino



**24.224.13**  
13,5 cm/5 1/4"



**24.224.18**  
17,5 cm/7"



**24.224.20**  
19,5 cm/7 1/2"



**24.224.26**  
26,5 cm/10 1/2"



**24.226.13**  
13,5 cm/5 1/4"



**24.226.15**  
15,5 cm/6 1/4"



**24.226.18**  
17,5 cm/7"



**24.226.20**  
21 cm/8 1/4"

schlankes Modell  
delicate pattern  
modèle gracile  
modelo delgado  
modello fino



1/2

RYDER



1/2

RYDER



Mit TC-Einsätzen  
 TC Lined  
 A mors TC  
 Con bocas TC  
 Con morso TC



½

HEANEY



**24.245.21**  
 20 cm/8"



**24.245.26**  
 26 cm/10¼"



½

WANGENSTEEN

**24.264.27**  
 27,5 cm/10¾"



½

HEGAR-VASCULAR



**24.276.14**  
 14 cm/5½"



**24.276.18**  
 18 cm/7"



**24.276.20**  
 20 cm/7¾"



**24.276.23**  
 23 cm/9"

Mikroprofil  
 micro profile  
 profil micro  
 perfil micro  
 profilo micro

Mit TC-Einsätzen  
TC Lined  
A mors TC  
Con bocas TC  
Con morso TC



½

**FINOCHIETTO**  
**24.315.27**  
26,5 cm/10½"



½

**SAROT**

**24.324.18**  
17,5 cm/7"

**24.324.26**  
26 cm/10¼"



½

**MATHIEU**

**24.374.14**  
14 cm/5½"

**24.374.17**  
17 cm/6¾"

**24.374.20**  
20 cm/7¾"



½

**MATHIEU**

**24.394.14**  
14 cm/5½"

**24.394.17**  
17 cm/6¾"

**24.394.20**  
20 cm/7¾"

schlankes Modell  
delicate pattern  
modèle gracile  
modelo delgado  
modello fino

Mit TC-Einsätzen  
TC Lined  
A mors TC  
Con bocas TC  
Con morso TC



1/2  
**LICHTENBERG**  
**24.486.20**  
19,5 cm/7<sup>3</sup>/<sub>4</sub>"



1/2  
**CASTROVIEJO**

**24.674.14**  
14,5 cm/5<sup>3</sup>/<sub>4</sub>"

**24.678.14**  
14,5 cm/5<sup>3</sup>/<sub>4</sub>"



1/2  
**24.678.18**  
18 cm/7"



1/2  
**CASTROVIEJO**  
**24.678.21**  
21,5 cm/8<sup>1</sup>/<sub>2</sub>"

*dimeda*<sup>®</sup>

SURGICAL INSTRUMENTS



Orthopädie, Osteosynthese  
Bone Surgery, Osteosynthesis  
Chirurgie osseuse, Ostéosynthèse  
Cirugía ósea, Osteosíntesis  
Chirurgia ossea, Osteosintesi



½

**BEYER**  
**32.201.18**  
 18 cm/7"



½

**ZAUFAL JANSEN**  
**32.205.18**  
 18 cm/7"



½

**MARQUARDT**  
**32.215.20**  
 20 cm/8"



½

**RUSKIN**  
**32.218.23**  
 23 cm/9"



½

**RUSKIN**  
**32.219.23**  
 23 cm/9"



**32.228.23**  
23 cm/9"

**32.228.27**  
27 cm/10½"



**32.229.23**  
23 cm/9"

**32.229.27**  
27 cm/10½"

½

STILLE LUER



**32.230.22**  
22 cm/8¾"



**32.231.22**  
22 cm/8¾"

½

STILLE LUER

Hohlmeißelzangen  
Bone Rongeurs  
Pinces-gouges  
Pinzas-gubias  
Pinze sgorbie

*dimeda*<sup>®</sup>

SURGICAL INSTRUMENTS



STILLE LUER  
32.235.23  
23 cm/9"



SAUERBRUCH  
31 cm/12¼"





**32.245.23**  
8 mm

**32.247.23**  
4 mm

**LEKSELL-STILLE**  
24,5 cm/9<sup>3</sup>/<sub>4</sub>"



**FRYKHOLM**  
**32.255.24**  
24 cm/9<sup>1</sup>/<sub>2</sub>"

Hohlmeißelzangen, Knochensplitterzangen  
 Bone Rongeurs, Bone Cutting Forceps  
 Pincés-gouges, Pincés coupantes à os  
 Pinzas-gubias, Pinzas cortantes para huesos  
 Pinze sgorbie, Cesioie per ossa

**dimed**<sup>®</sup>

SURGICAL INSTRUMENTS



1/2

**ECHLIN**  
23 cm/9"



**32.259.02**  
2 mm



**32.259.03**  
3 mm



**32.259.23**  
4 mm

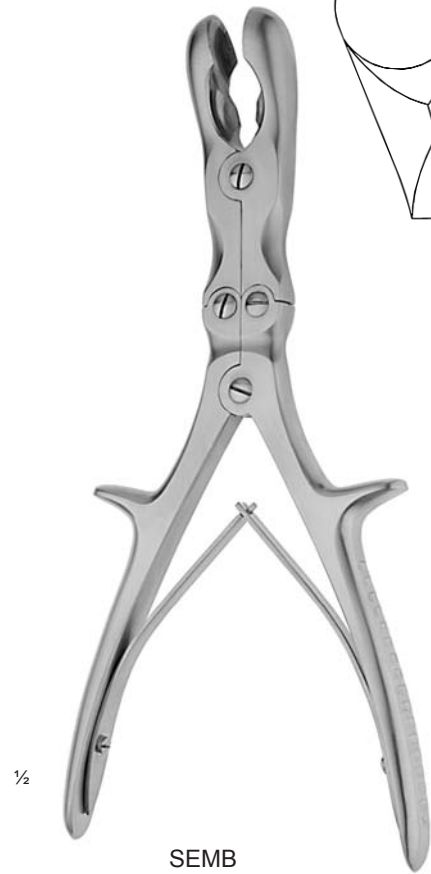
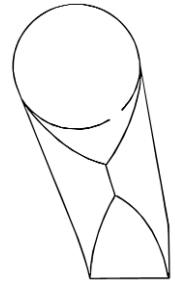

1/2

**SEMB**  
**32.261.22**  
22,5 cm/9"



1/2

**CLEVELAND**  
**32.106.15**  
15 cm/5 3/4"



1/2

**CLEVELAND**  
**32.270.17**  
17 cm/6 3/4"



LISTON

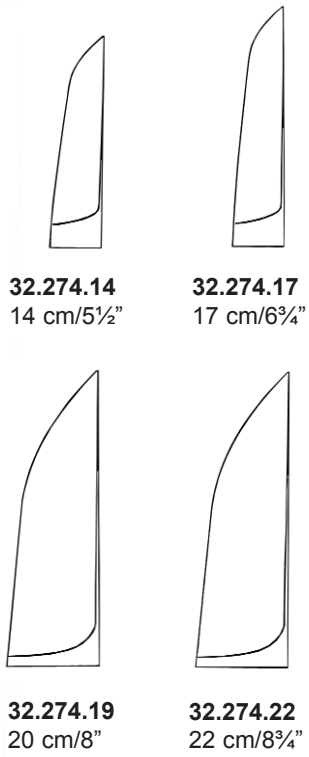

LISTON

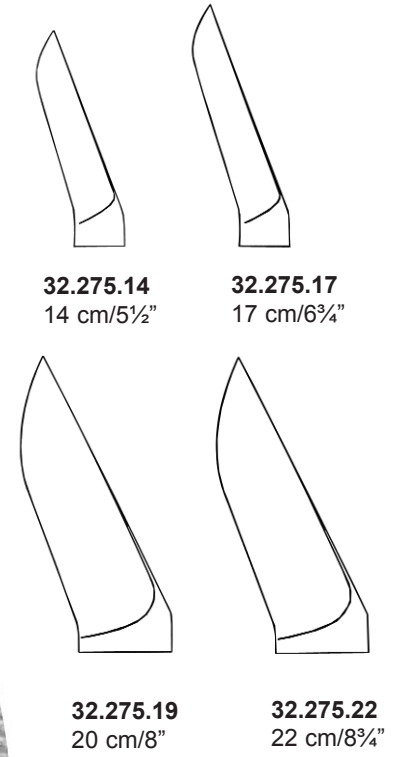

BOEHLER  
**32.280.15**  
 15 cm/5¾"

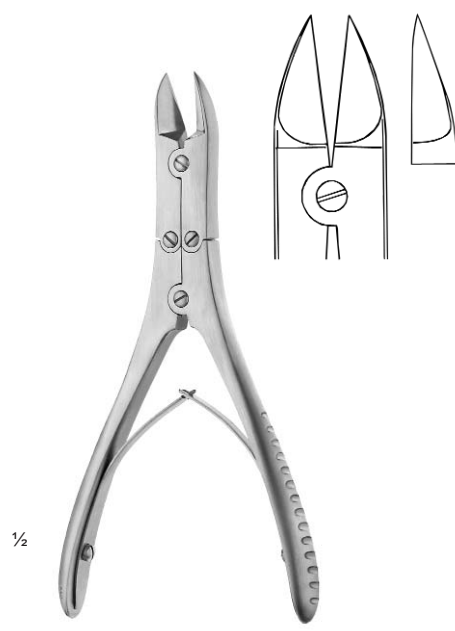
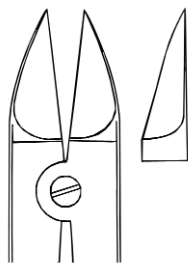

BOEHLER  
**32.281.15**  
 15 cm/5¾"

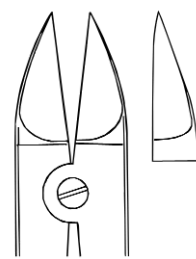



MCINDOE  
32.284.17  
19 cm/7½"

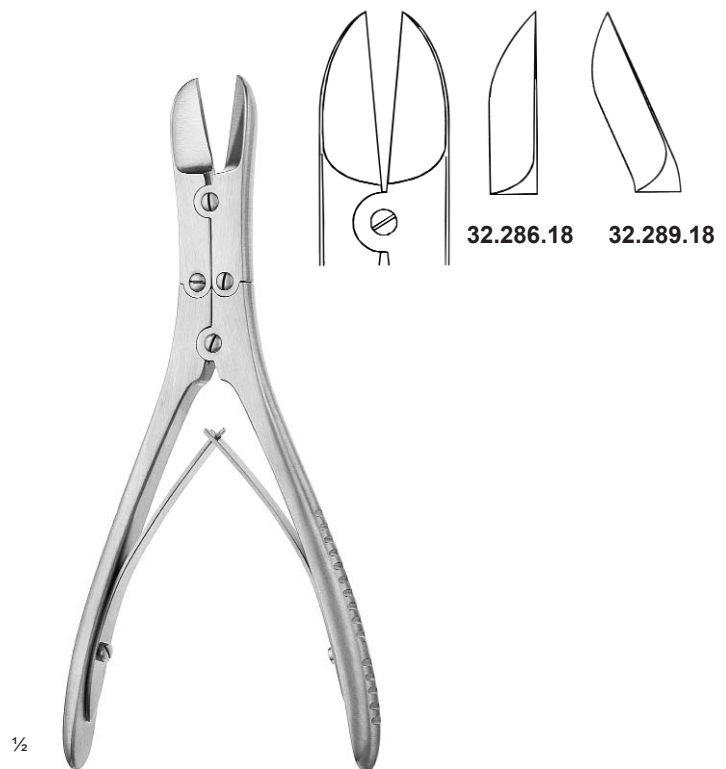

RUSKIN LISTON  
18 cm/7"

Knochensplitterzangen  
Bone Cutting Forceps  
Pincès coupantes à os  
Pinzas cortantes para hueso  
Cesoie per ossa

*dimeda*<sup>®</sup>

SURGICAL INSTRUMENTS



STILLE LISTON  
**32.290.26**  
26,5 cm/10<sup>1</sup>/<sub>4</sub>"



STILLE LISTON  
**32.290.27**  
27,5 cm/10<sup>3</sup>/<sub>4</sub>"

Knochensplitterzangen  
Bone Cutting Forceps  
Pincès coupantes à os  
Pinzas cortantes para hueso  
Cesoie per ossa

*dimeda*<sup>®</sup>

SURGICAL INSTRUMENTS

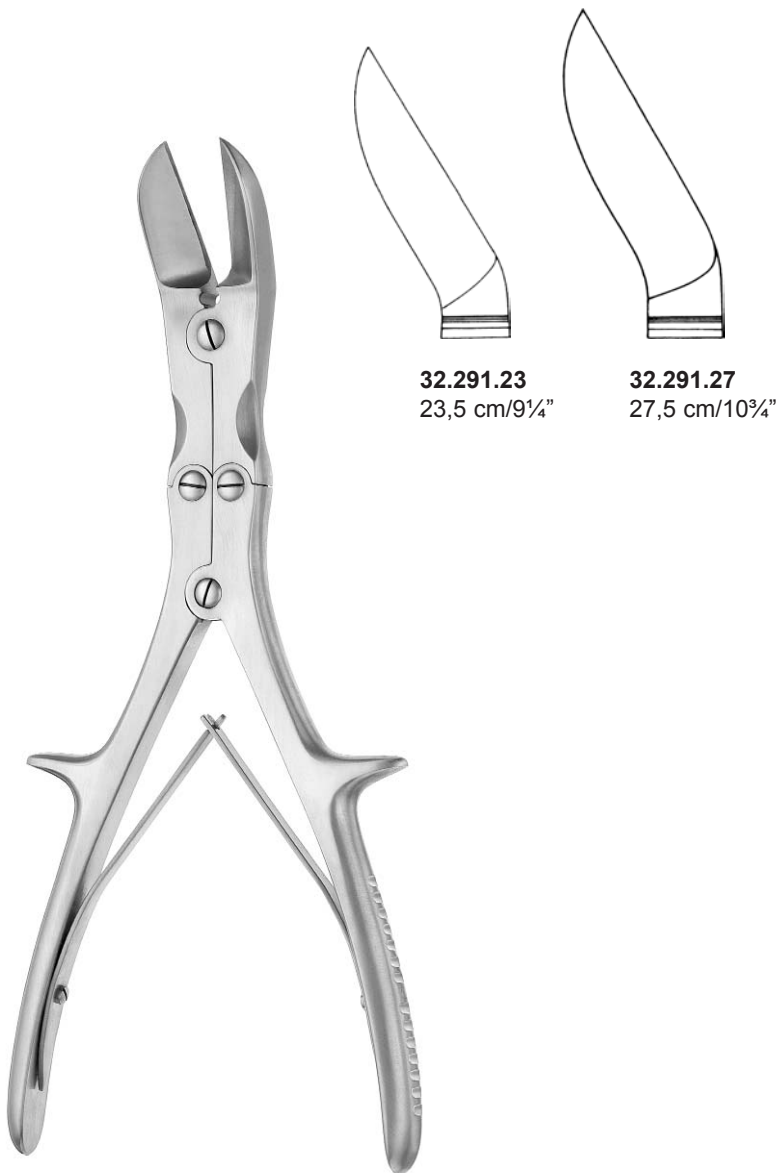

1/2

STILLE LISTON



½

STILLE HORSLEY  
**32.293.27**  
27 cm/10½"



½

SEMB  
**32.295.24**  
24 cm/9½"

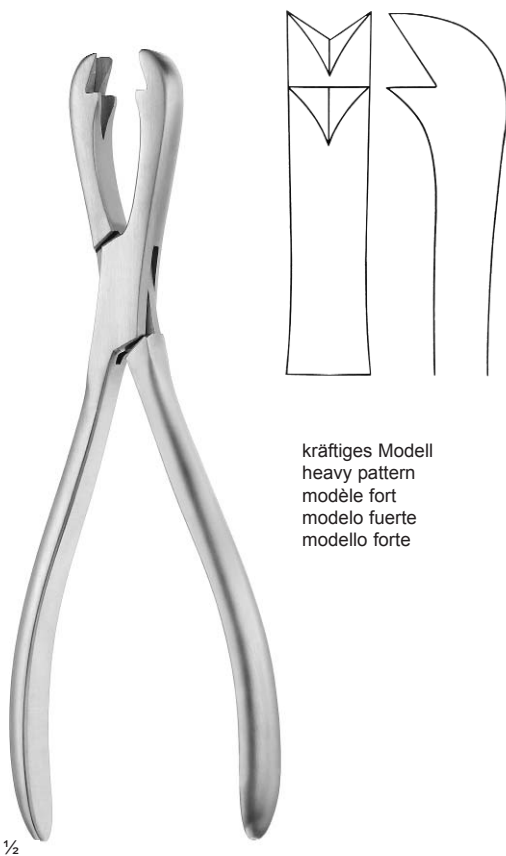

kräftiges Modell  
heavy pattern  
modèle fort  
modelo fuerte  
modello forte

½

**FERGUSSON**  
**32.360.21**  
21 cm/8¼"



½

**LANGENBECK**  
**32.362.21**  
21 cm/8¼"



Knochenhalte­zangen  
Bone Holding Forceps  
Daviers porte os  
Pinzas para huesos  
Tenaglie per ossa

**dimeda**<sup>®</sup>

SURGICAL INSTRUMENTS

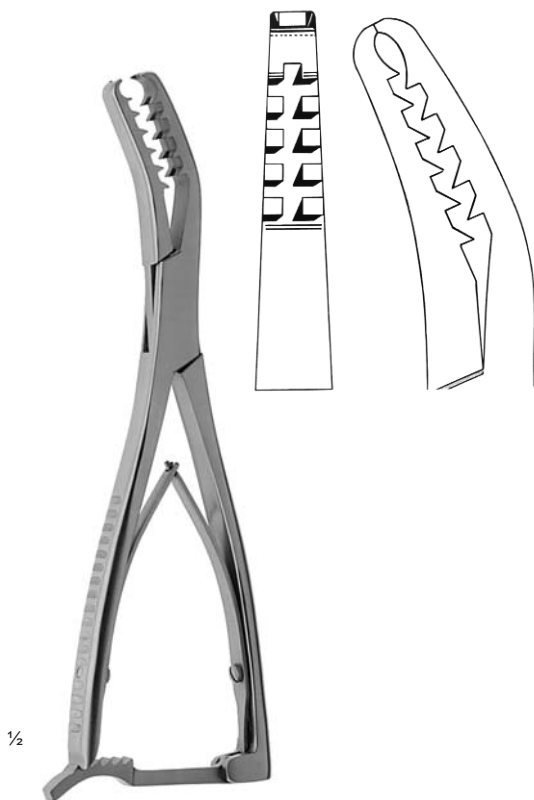

SEMB  
**32.364.19**  
19 cm/7½"

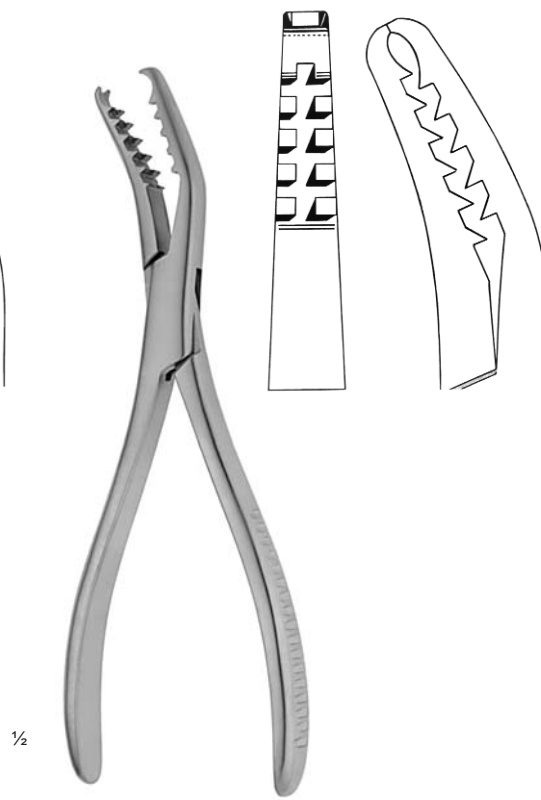

SEMB  
**32.365.19**  
19 cm/7½"



**32.386.20**  
20 cm/8"

Sternummeißel, Raspatorien  
 Sternum Chisel, Periosteal Elevators  
 Ciseau-burin à sternum, Rugines-raspatoires  
 Cinceles, Periostótomos  
 Scalpello per sterno, Periostotomi

**dimed**<sup>®</sup>

SURGICAL INSTRUMENTS

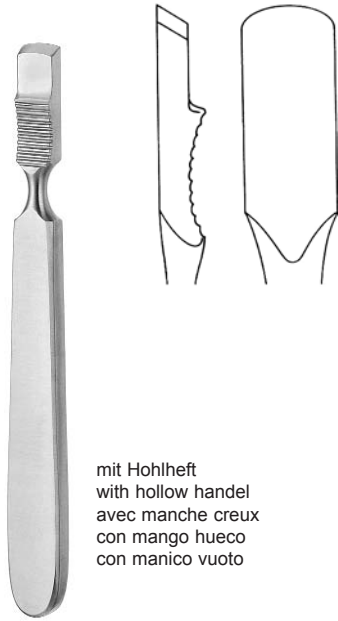

mit Hohlheft  
 with hollow handel  
 avec manche creux  
 con mango hueco  
 con manico vuoto

**FARABEU**  
**32.702.15**  
 15 cm/6"

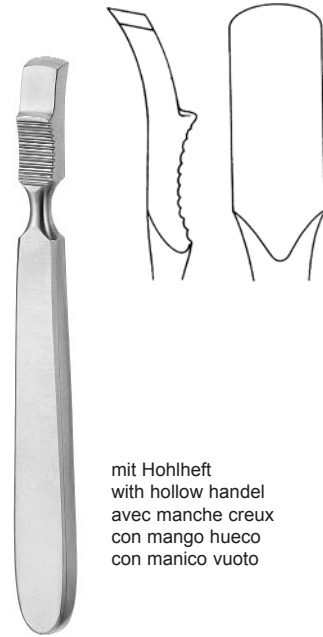

mit Hohlheft  
 with hollow handel  
 avec manche creux  
 con mango hueco  
 con manico vuoto

**FARABEU**  
**32.703.15**  
 15 cm/6"

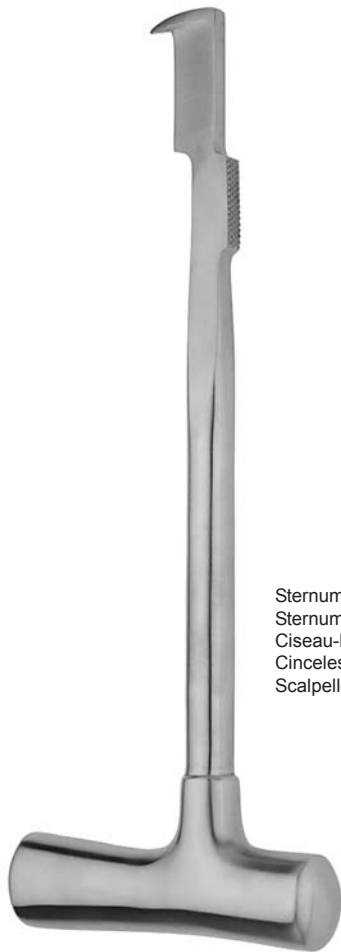

Sternummeißel  
 Sternum Chisel  
 Ciseau-burin à sternum  
 Cinceles  
 Scalpello per sterno

1/2

**LEBSCHE**  
**32.678.24**  
 24,5 cm/9 3/4"

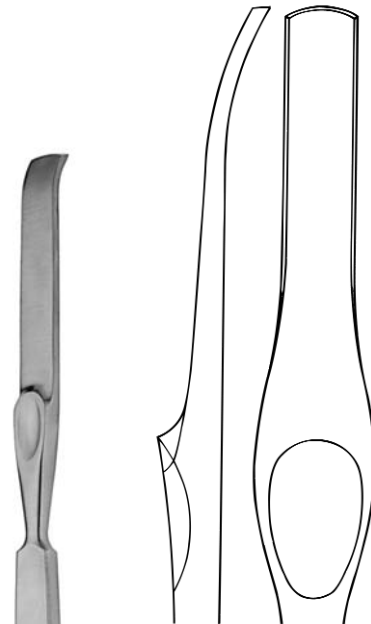

1/2

**LAMBOTTE**  
 21 cm/8 1/4"

**32.705.05**  
 5 mm

**32.705.10**  
 10 mm

**32.705.15**  
 15 mm

**32.705.20**  
 20 mm

**32.705.25**  
 25 mm

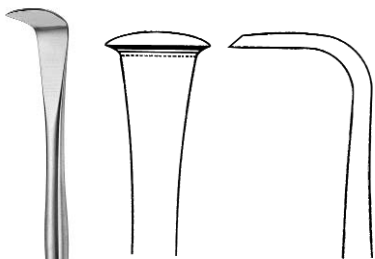

**32.711.18**  
 18 cm/7"

mit Hohlheft  
 with hollow handel  
 avec manche creux  
 con mango hueco  
 con manico vuoto

½

LANGENBECK

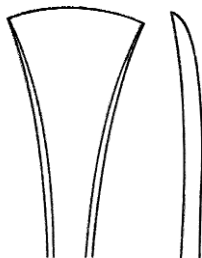

**32.753.20**  
 19 cm/7½"



½

ALEXANDER

16 cm/6¼" **32.715.16**  
 20 cm/7¾" **32.715.20**

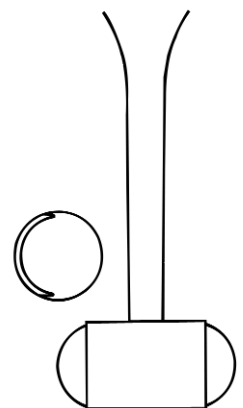
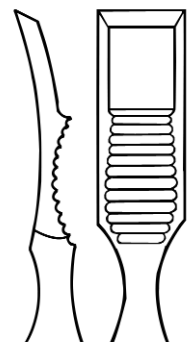



rechts gebogen  
 right curved  
 courbé à droite  
 curvo a la derecha  
 curvo destro

mit Hohlheft  
 with hollow handel  
 avec manche creux  
 con mango hueco  
 con manico vuoto

für Erwachsene  
 for adults  
 pour adultes  
 para adultos  
 per adulti

½

**DOYEN**  
**32.721.17**  
 17 cm/6¾"



links gebogen  
 left curved  
 courbé à izquierda  
 curvo a la gauche  
 curvo sinistro

mit Hohlheft  
 with hollow handel  
 avec manche creux  
 con mango hueco  
 con manico vuoto

für Erwachsene  
 for adults  
 pour adultes  
 para adultos  
 per adulti

½

**DOYEN**  
**32.723.17**  
 17 cm/6¾"



rechts gebogen  
 right curved  
 courbé à droite  
 curvo a la derecha  
 curvo destro

mit Hohlheft  
 with hollow handel  
 avec manche creux  
 con mango hueco  
 con manico vuoto

für Kinder  
 for children  
 pour enfants  
 para nin s  
 per bambini

½

**DOYEN**  
**32.725.17**  
 17 cm/6¾"



links gebogen  
 left curved  
 courbé à izquierda  
 curvo a la gauche  
 curvo sinistro

mit Hohlheft  
 with hollow handel  
 avec manche creux  
 con mango hueco  
 con manico vuoto

für Kinder  
 for children  
 pour enfants  
 para nin s  
 per bambini

½

**DOYEN**  
**32.727.17**  
 17 cm/6¾"



½

DOYEN  
24 cm/9½"

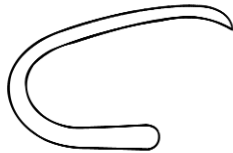

**32.721.24**

rechts gebogen  
right curved  
courbé à droite  
curvo a la derecha  
curvo destro

mit Hohlheft  
with hollow handel  
avec manche creux  
con mango hueco  
con manico vuoto

für Erwachsene  
for adults  
pour adultes  
para adultos  
per adulti

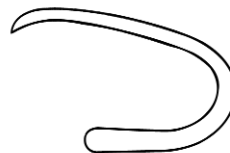

**32.723.24**

links gebogen  
left curved  
courbé à izquierda  
curvo a la gauche  
curvo sinistro

mit Hohlheft  
with hollow handel  
avec manche creux  
con mango hueco  
con manico vuoto

für Erwachsene  
for adults  
pour adultes  
para adultos  
per adulti

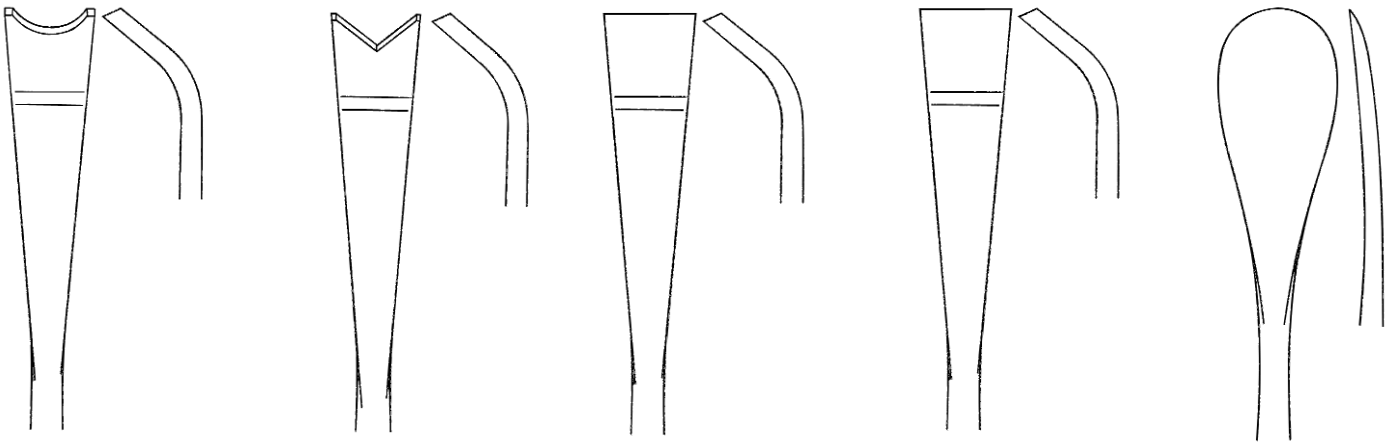

½  
 SEMB  
**32.729.01**  
 18,5 cm/7¼"  
 12 mm

½  
 SEMB  
**32.729.02**  
 21,5 cm/8½"  
 12 mm

½  
 SEMB  
**32.729.03**  
 18,5 cm/7¼"  
 13 mm

½  
 SEMB  
**32.729.04**  
 21,5 cm/8½"  
 13 mm

½  
 SEMB  
**32.729.05**  
 21 cm/8¼"  
 15 mm

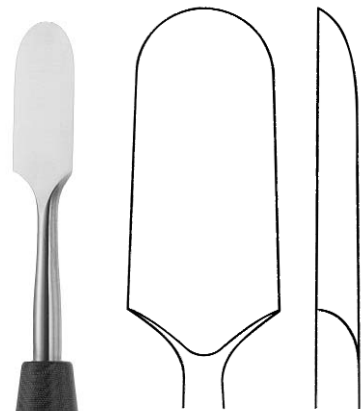

mit Kunststoffgriff  
 with plastic handle  
 avec manche en matière plastiue  
 con mango plástico  
 con manico in plastica

½ **32.717.20**  
 20 cm/8"

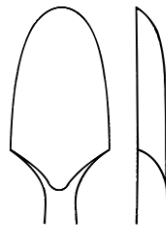

mit Kunststoffgriff  
 with plastic handle  
 avec manche en matière plastiue  
 con mango plástico  
 con manico in plastica

½ **32.774.14**  
 20 cm/8"  
 14 mm



mit Kunststoffgriff  
 with plastic handle  
 avec manche en matière plastiue  
 con mango plástico  
 con manico in plastica

½ **32.775.14**  
 20 cm/8"  
 14 mm



Schmal, mit Kunststoffgriff  
 narrow, con plastic handle  
 étroit, avec manche en matière plastiue  
 estrecho, con mango plástico  
 diritto, con manico in plastica

½ **32.779.06**  
 18 cm/7"  
 6 mm



mit Kunststoffgriff  
 with plastic handle  
 avec manche en matière plastiue  
 con mango plástico  
 con manico in plastica

½ **32.781.06**  
 18 cm/7"  
 6 mm



extra schmal, mit Kunststoffgriff  
 extra narrow, con plastic handle  
 très étroit, avec manche en plastiue  
 muy estrecho, con mango plástico  
 molto stretto, con manico in plastica

½ **32.783.03**  
 18 cm/7"  
 3 mm

Knochendraht, Flachzangen  
 Bone Wire, Flat Nose Pliers  
 Fil à os, Pincas plates  
 Hilo para huesos, Alicates de pico plano  
 Filo per ossa, Tenaglie piatte

**dimeda**®



SURGICAL INSTRUMENTS



weich, Rolle mit 10 m  
 soft, coil of 10 m  
 malléable, en rouleaux de 10 m  
 blando, rolo de 10 m  
 malleabile, rotolo di 10 m

- |                              |                              |
|------------------------------|------------------------------|
| <b>32.530.02</b><br>ø 0,2 mm | <b>32.530.08</b><br>ø 0,8 mm |
| <b>32.530.03</b><br>ø 0,3 mm | <b>32.530.09</b><br>ø 0,9 mm |
| <b>32.530.04</b><br>ø 0,4 mm | <b>32.530.10</b><br>ø 1,0 mm |
| <b>32.530.05</b><br>ø 0,5 mm | <b>32.530.11</b><br>ø 1,1 mm |
| <b>32.530.06</b><br>ø 0,6 mm | <b>32.530.12</b><br>ø 1,2 mm |
| <b>32.530.07</b><br>ø 0,7 mm | <b>32.530.15</b><br>ø 1,5 mm |



- |   |   |   |
|---|---|---|
|  |  |  |
| <b>33.532.01</b>  | <b>33.532.02</b>  | <b>33.532.03</b>  |





parallel fassend  
 parallel grip  
 action parallèla  
 acción paralela  
 afferramento parallelo

½

18 cm/7"



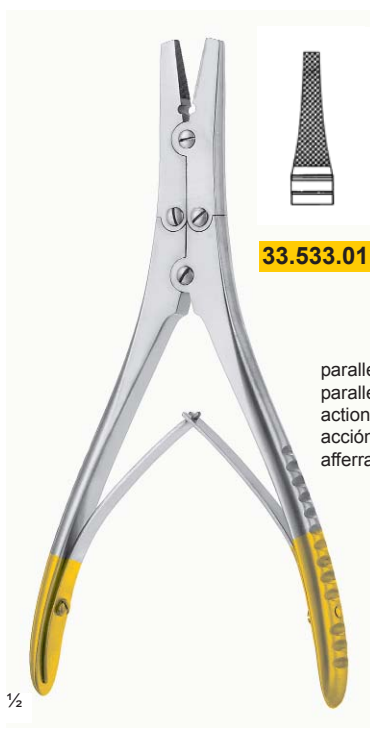

½

- |   |   |
|---|---|
|  |  |
| <b>33.537.01</b><br>18 cm/7"  | <b>33.537.02</b><br>18 cm/7"  |
|  |  |
| <b>33.537.03</b><br>18 cm/7"  | <b>33.537.04</b><br>14,5 cm/5¾"   |



½

18 cm/7"

- |   |   |   |
|---|---|---|
|  |  |  |
| <b>33.533.01</b>  | <b>33.533.02</b>  | <b>33.533.03</b>  |

parallel fassend  
 parallel grip  
 action parallèla  
 acción paralela  
 afferramento parallelo

Mit TC-Einsätzen  
 TC Lined  
 A mors TC  
 Con bocas TC  
 Con morso TC





**33.538.01**  
 17,5 cm/7"



**33.538.02**  
 17 cm/6<sup>3</sup>/<sub>4</sub>"

mit Kreuzrinne  
 with crosswise groove  
 avec rainures croisées  
 con ranura en forma de cruz  
 con scannelatura a croce



Spitz- und Flachzange  
 Flat Nose plier, pointed  
 Pincès plates / aiguës  
 Alicates planos/agudos  
 Tenaglie piate/appuntate

**33.538.19**  
 19,5 cm/7<sup>3</sup>/<sub>4</sub>"



**33.568.14**  
 14 cm/5<sup>1</sup>/<sub>2</sub>"



**GOSLEE**  
**33.569.14**  
 14 cm/5<sup>1</sup>/<sub>2</sub>"

Drahtwirbelzangen  
 Wire Twisting Forceps  
 Pincès à torsader le fil  
 Pinzas para torcer alambre  
 Pinze per ritorcere fili

**dimed**<sup>®</sup>

SURGICAL INSTRUMENTS

Mit TC-Einsätzen  
 TC Lined  
 A mors TC  
 Con bocas TC  
 Con morso TC



½

**33.600.20**  
 20 cm/8"



½

**33.552.17**  
 17 cm/6¾"

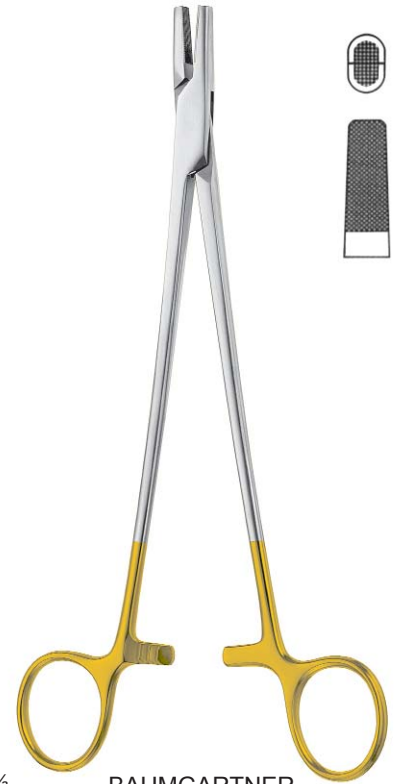

½

**BAUMGARTNER**  
**33.599.20**  
 20 cm/8"



½

**33.600.15**  
 15,5 cm/6"



½

**33.601.15**  
 15 cm/6"



½

**33.601.19**  
 19 cm/7½"

Seitenschneider, Drahtkneifzangen  
 Wire Cutting Pliers  
 Pince coupantes de côte, Pincas à couper le fil  
 Tenazas de corte lateral, Alicates para cortar alambre  
 Tenaglie tagliafili laterali, Tenaglie tagliafili

**dimed**<sup>®</sup>

SURGICAL INSTRUMENTS

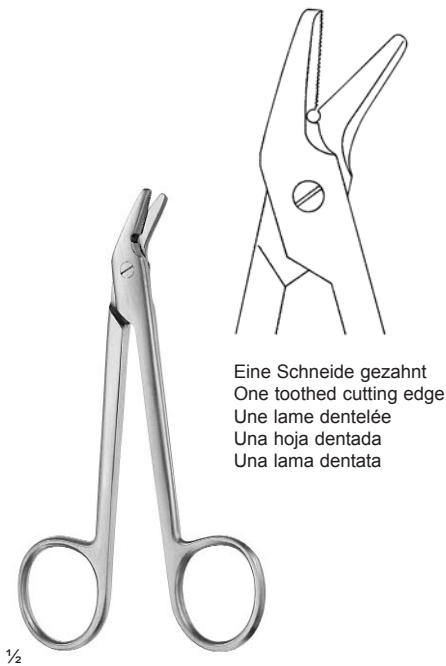

Eine Schneide gezahnt  
 One toothed cutting edge  
 Une lame dentelée  
 Una hoja dentada  
 Una lama dentata

½

**08.831.12**  
 12 cm/4¾"



Eine Schneide gezahnt  
 One toothed cutting edge  
 Une lame dentelée  
 Una hoja dentada  
 Una lama dentata

½

**08.835.12**  
 12 cm/4¾"



½

**08.838.12**  
 12,5 cm/5"



½

**33.545.16**  
 17 cm/6¾"



½

**33.545.22**  
 22,5 cm/8¾"

Mit TC-Einsätzen  
 TC Lined  
 A mors TC  
 Con bocas TC  
 Con morso TC

Seitenschneider, Drahtkneifzangen  
 Wire Cutting Pliers  
 Pince coupantes de côte, Pincas à couper le fil  
 Tenazas de corte lateral, Alicates para cortar alambre  
 Tenaglie tagliafilii laterali, Tenaglie tagliafilii

**dimed**<sup>®</sup>

SURGICAL INSTRUMENTS

Mit TC-Einsätzen  
 TC Lined  
 A mors TC  
 Con bocas TC  
 Con morso TC



1/2

**33.546.18**  
 17,5 cm/7"



1/2

REILL  
**33.547.17**  
 17,5 cm/7"



1/2

HARVEY  
**33.547.23**  
 23,5 cm/9 1/4"



1/2

**87.574.15**  
 14 cm/5 1/2"



**56.102.23**  
23 cm/9¼"

½



**56.105.22**  
22 cm/8¾"

½

Sternum Schere  
Sternum scissors  
Ciseaux a sternum  
Tijera de esternón  
Forbici per sterno



½

**SCHUMACHER**  
**56.148.21**  
21 cm/8¼"

Rippenschere mit ziehendem Schnitt  
Rib Shears with drawing cut  
Costotome avec lame excentrée  
Costótomo con hoja de retroacción  
Costotomo con lama eccentrica a scorrimento



**GLUCK**  
**56.107.22**  
22 cm/8<sup>3</sup>/<sub>4</sub>"



**STILLE**  
**56.111.21**  
21 cm/8<sup>1</sup>/<sub>4</sub>"



CORYLLOS  
**56.123.35**  
35 cm/14"

CORYLLOS  
**56.125.35**  
35 cm/14"



½

BETHUNE  
**56.126.34**  
34 cm/13½"



½

COOLEY  
**56.128.35**  
35 cm/14"





SAUERBUCH  
56.131.26  
26 cm/10¼"



GIERTZ-STILLE  
56.137.27  
27 cm/10½"

**56.147.28**  
32 cm/12½"

für die rechte Hand  
for right hand  
pour la main droite  
para la mano derecha  
per la mano destra

**56.149.28**  
32 cm/12½"

für die linke Hand  
for left hand  
pour la main gauche  
para la mano izquierda  
per la mano sinistra

für die erste Rippe  
for the first rib  
pour la première côte  
para la primera costilla  
per la prima costolaz

½



SAUERBUCH-FREY  
**56.141.36**  
36 cm/14"

½



BRUNNER



Rippensperrer  
Rib Spreaders  
Ecarteurs des côtes  
Separadores costales  
Divaricatori costali

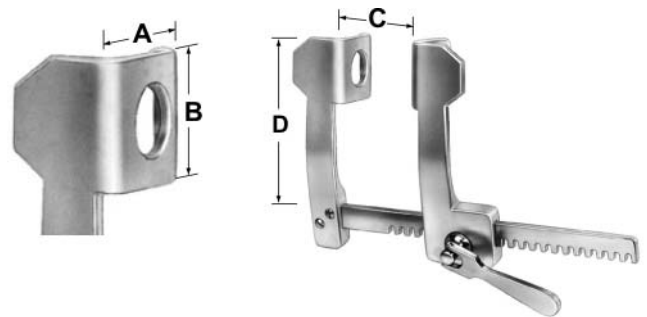

	A	B	C	D
<b>56.210.16</b>	40 mm	40 mm	165 mm	110 mm
<b>56.210.20</b>	45 mm	65 mm	200 mm	140 mm
<b>56.210.25</b>	70 mm	65 mm	250 mm	140 mm
<b>56.210.30</b>	70 mm	65 mm	300 mm	140 mm

für Erwachsene · for adults · pour adultes · para adultos · per adulti

FINOCHIETTO



	A	B	C	D
<b>56.212.12</b>	14 mm	20 mm	120 mm	105 mm

für Säuglinge · for babies · pour bébé · para bebés · per neonati

FINOCHIETTO (modif.)

**ALUMINIUM**

Rippensperrer  
 Rib Spreaders  
 Ecarteurs des côtes  
 Separadores costales  
 Divaricatori costali

**dimeda**<sup>®</sup>

SURGICAL INSTRUMENTS

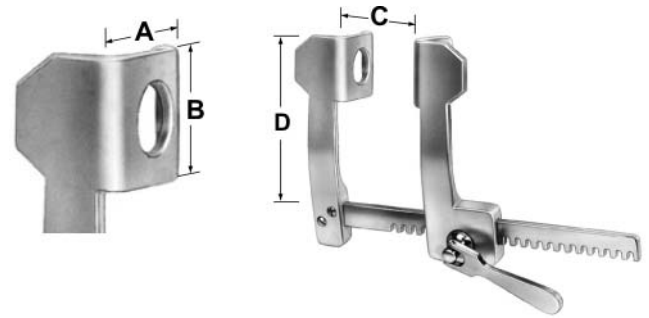
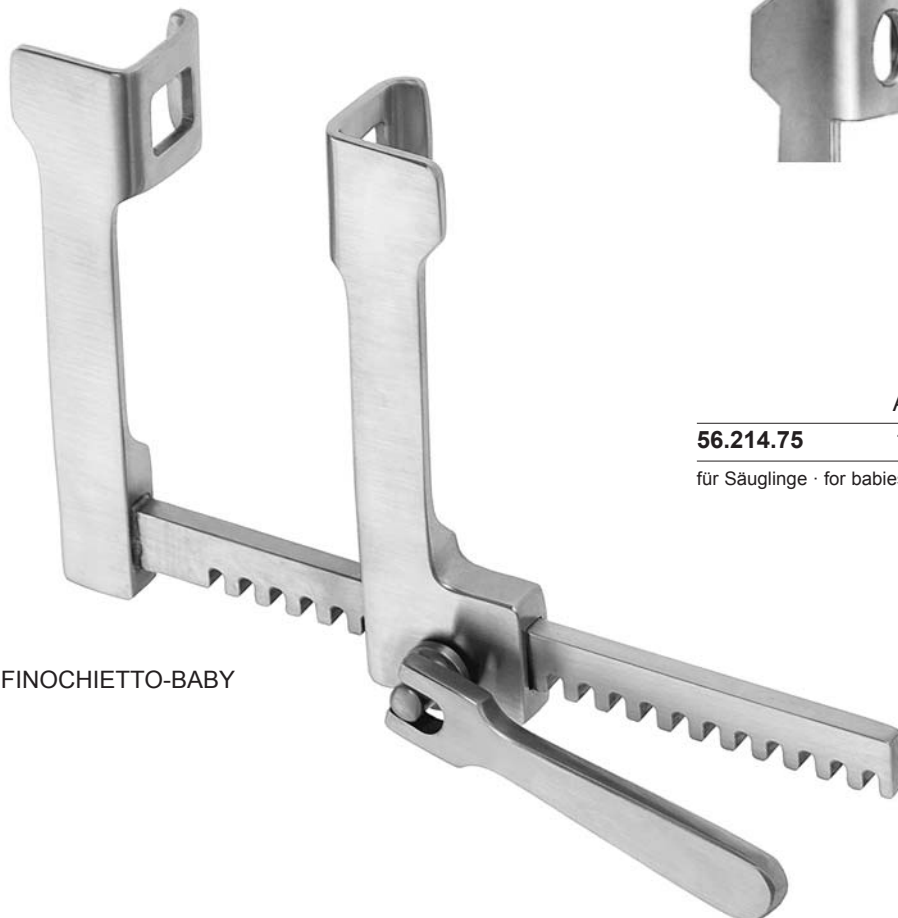

	A	B	C	D
<b>56.214.75</b>	14 mm	15 mm	75 mm	55 mm

für Säuglinge · for babies · pour bébé · para bebés · per neonati

FINOCHIETTO-BABY



	A	B	C	D
<b>56.220.01</b>	12 mm	17 mm	95 mm	55 mm

für Säuglinge · for babies · pour bébé · para bebés · per neonati

	A	B	C	D
<b>56.220.02</b>	15 mm	30 mm	140 mm	80 mm
<b>56.220.07</b>	29 mm	34 mm	140 mm	110 mm

für Kinder · for children · pour enfants · para niños · per bambini

COOLEY  
**ALUMINIUM**

Rippensperrer  
 Rib Spreaders  
 Ecarteurs des côtes  
 Separadores costales  
 Divaricatori costali

**dimeda**<sup>®</sup>

SURGICAL INSTRUMENTS

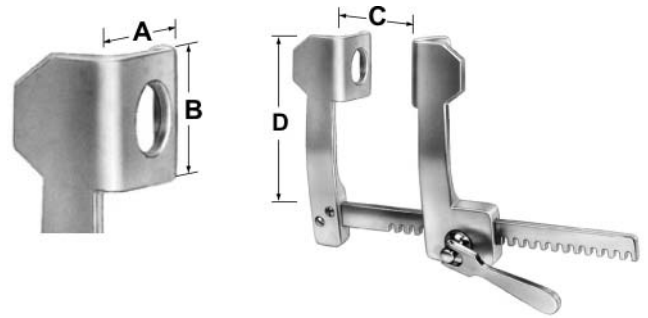

	A	B	C	D
<b>56.220.03</b>	22 mm	45 mm	150 mm	110 mm

für Kinder · for children · pour enfants · para niños · per bambini

	A	B	C	D
<b>56.220.04</b>	34 mm	51 mm	200 mm	145 mm
<b>56.220.08</b>	34 mm	100 mm	180 mm	180 mm

für Erwachsene · for adults · pour adultes · para adultos · per adulti

	A	B	C	D
<b>56.220.09</b>	34 mm	100 mm	180 mm	180 mm

für Erwachsene mit Fadenfänger · for adults with suture separator · pour adultes con il separator del suture · para adultos con separator de la sutura · per adulti avec le separator de suture

	A	B	C	D
<b>56.220.10</b>	34 mm	115 mm	230 mm	205 mm

für Erwachsene extra groß · for adults extra large · pour adultes grand supplémentaire · para adultos grande adicional · per adulti grande supplementare

COOLEY  
**ALUMINIUM**

Rippensperrer  
 Rib Spreaders  
 Ecarteurs des côtes  
 Separadores costales  
 Divaricatori costali

**dimeda**<sup>®</sup>

SURGICAL INSTRUMENTS

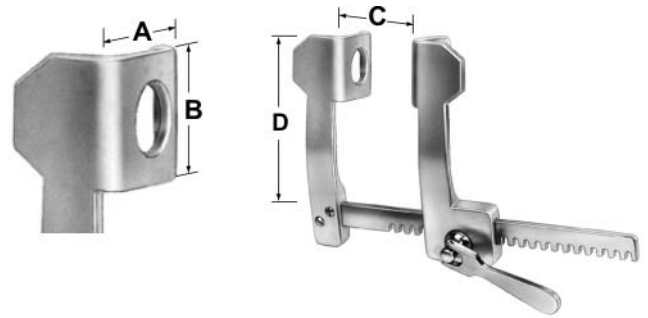

	A	B	C	D
<b>56.220.05</b>	10 mm	15,5 mm	75 mm	55 mm

für Neugeborene · neonatal · néonatal · neonatal · neonatale

COOLEY  
**ALUMINIUM**



	A	B	C	D
<b>56.220.06</b>	20 mm	24 mm	100 mm	80 mm

für Säuglinge · for babies · pour bébé · para bebés · per neonati

COOLEY  
**ALUMINIUM**

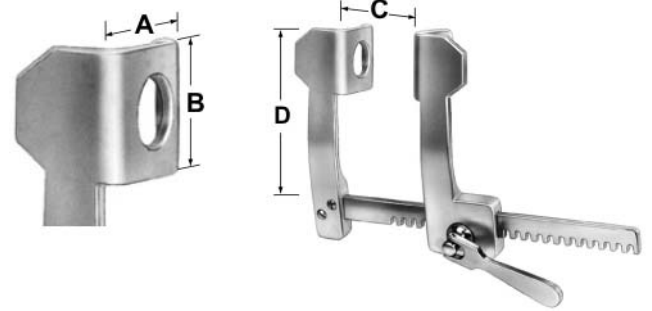

	C	D
<b>56.220.60</b>	215 mm	140 mm

Mammaria Sperrer, komplett · mammaria retractors, complete · Ecarteurs à mammaria, complet · Seperadores mammaria, completo · Divaricatori per mammaria, completo

	C	D
<b>56.220.61</b>	215 mm	140 mm

Sperrer allein · retractor only · ecarteur seul · separador suelto · divaricatore solo



	A	B
<b>56.220.62</b>	30 mm	50 mm

Mammariablatt komplett, mit Aufnahmeblatt links und rechts · Mammaria blade complete, with holding blades left and right · Mammaria valves complet, avec valves droite et gauche · Mammaria valvas completo, con valvas izquierda y derecha · Mammaria valve completo, con valve sinistra e destra

	A	B
<b>56.220.63</b>	30 mm	100 mm
<b>56.220.64</b>	40 mm	100 mm

Sternumblätter, Paar · sternum blades, pair · sternum valves, paire · sternum valvas, pareja · sternum valve, coppia

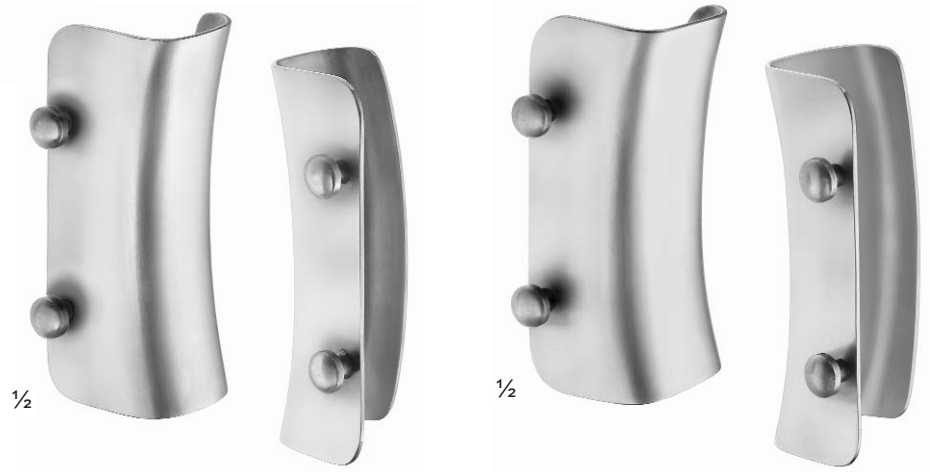

**56.220.63**

**56.220.64**



Rippensperrer  
 Rib Spreaders  
 Ecarteurs des côtes  
 Separadores costales  
 Divaricatori costali

**dimeda**<sup>®</sup>

SURGICAL INSTRUMENTS

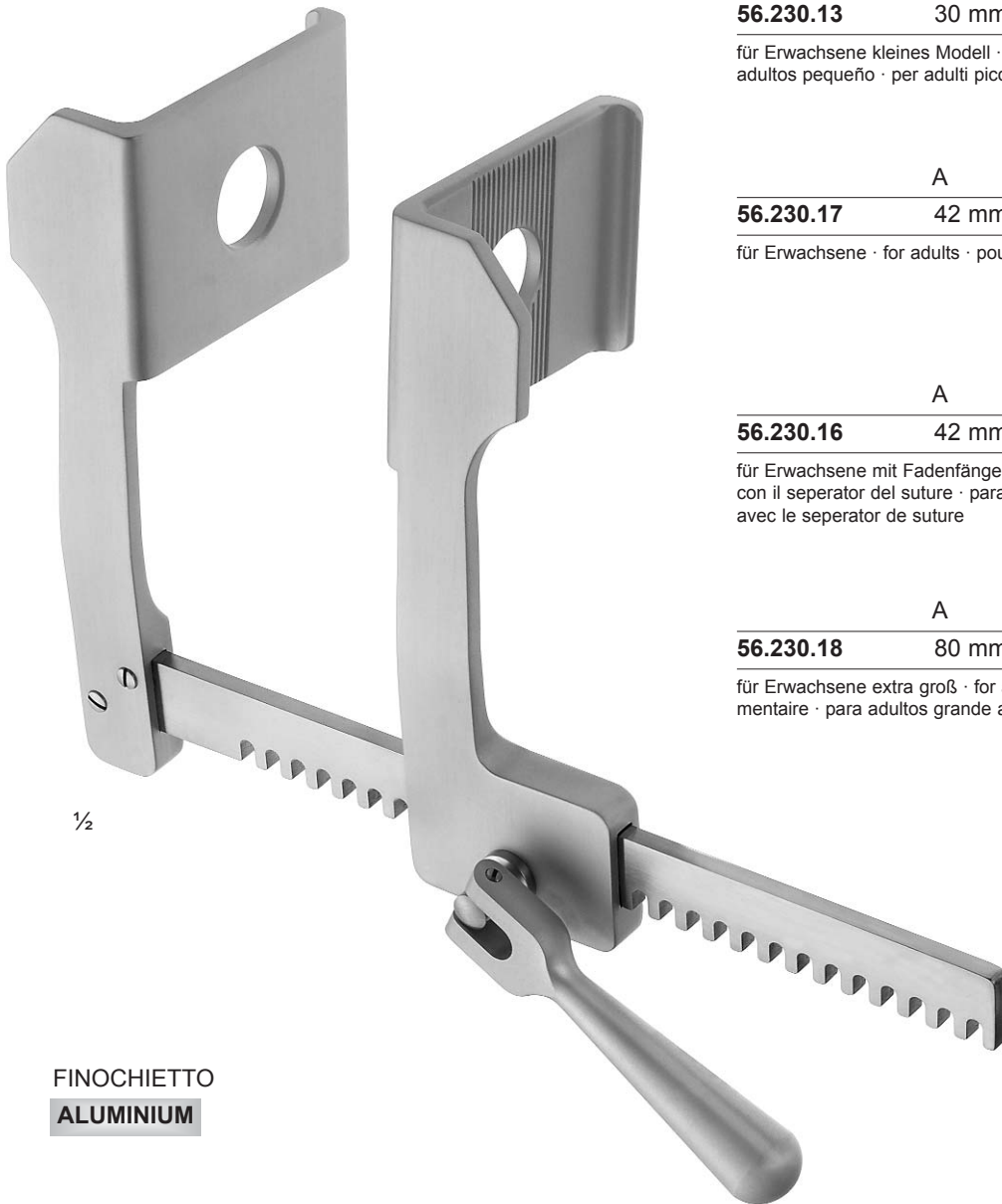
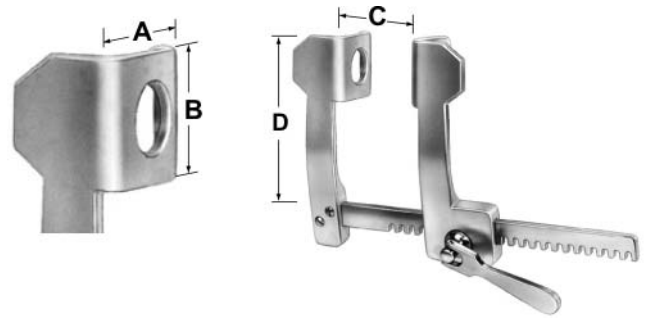

1/2

FINOCHIETTO  
**ALUMINIUM**

	A	B	C	D
<b>56.230.13</b>	30 mm	45 mm	145 mm	110 mm

für Erwachsene kleines Modell · for adults small model · pour adultes petit · para adultos pequeño · per adulti piccolo

	A	B	C	D
<b>56.230.17</b>	42 mm	62 mm	180 mm	145 mm

für Erwachsene · for adults · pour adultes · para adultos · per adulti

	A	B	C	D
<b>56.230.16</b>	42 mm	62 mm	180 mm	145 mm

für Erwachsene mit Fadenfänger · for adults with suture separator · pour adultes con il separator del suture · para adultos con separator de la sutura · per adulti avec le separator de suture

	A	B	C	D
<b>56.230.18</b>	80 mm	65 mm	180 mm	145 mm

für Erwachsene extra groß · for adults extra large · pour adultes grand supplémentaire · para adultos grande adicional · per adulti grande supplementare

Rippensperrer  
 Rib Spreaders  
 Ecarteurs des côtes  
 Separadores costales  
 Divaricatori costali

**dimeda**<sup>®</sup>

SURGICAL INSTRUMENTS

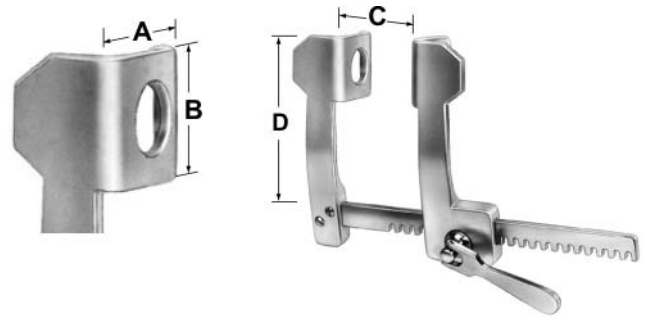

1/2

FINOCHIETTO BABY-HAIGHT

**ALUMINIUM**

	A	B	C	D
<b>56.232.10</b>	27 mm	31 mm	100 mm	80 mm

für Kinder · for children · pour enfants · para niños · per bambini

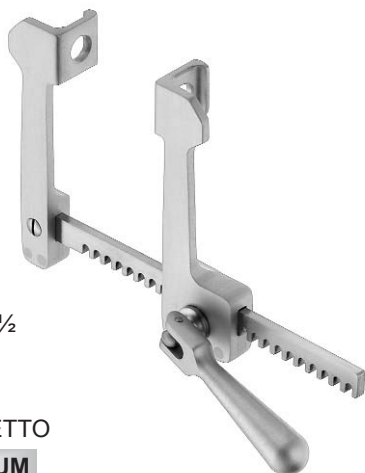

1/2

FINOCHIETTO

**ALUMINIUM**

	A	B	C	D
<b>56.234.40</b>	12 mm	15 mm	100 mm	55 mm

für Säuglinge · for babies · pour bébé · para bebés · per neonati

Rippensperrer  
 Rib Spreaders  
 Ecarteurs des côtes  
 Separadores costales  
 Divaricatori costali

**dimeda**<sup>®</sup>

SURGICAL INSTRUMENTS

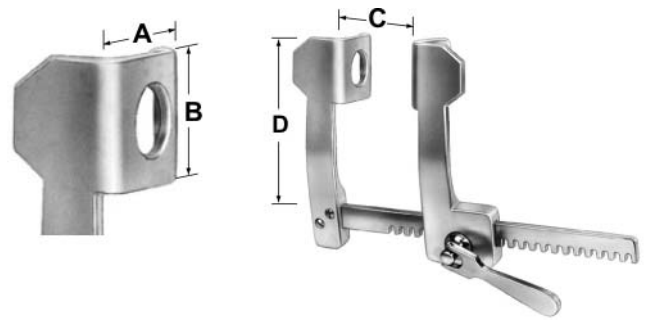

**FINOCHIETTO**  
**ALUMINIUM**

	A	B	C	D
<b>56.234.41</b>	28 mm	30 mm	143 mm	80 mm
<b>56.234.42</b>	31 mm	45 mm	210 mm	110 mm

für Kinder · for children · pour enfants · para niños · per bambini

	A	B	C	D
<b>56.234.43</b>	42 mm	62 mm	245 mm	145 mm
<b>56.234.44</b>	74 mm	64 mm	250 mm	145 mm

für Erwachsene · for adults · pour adultes · para adultos · per adulti

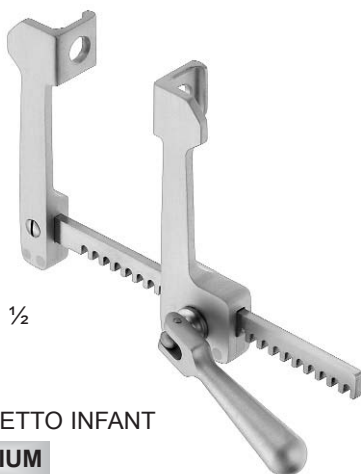

**FINOCHIETTO INFANT**  
**ALUMINIUM**

	A	B	C	D
<b>56.234.75</b>	12 mm	15 mm	75 mm	55 mm

für Säuglinge · for babies · pour bébé · para bebés · per neonati

Rippensperrer  
 Rib Spreaders  
 Ecarteurs des côtes  
 Separadores costales  
 Divaricatori costali

**dimeda**<sup>®</sup>

SURGICAL INSTRUMENTS

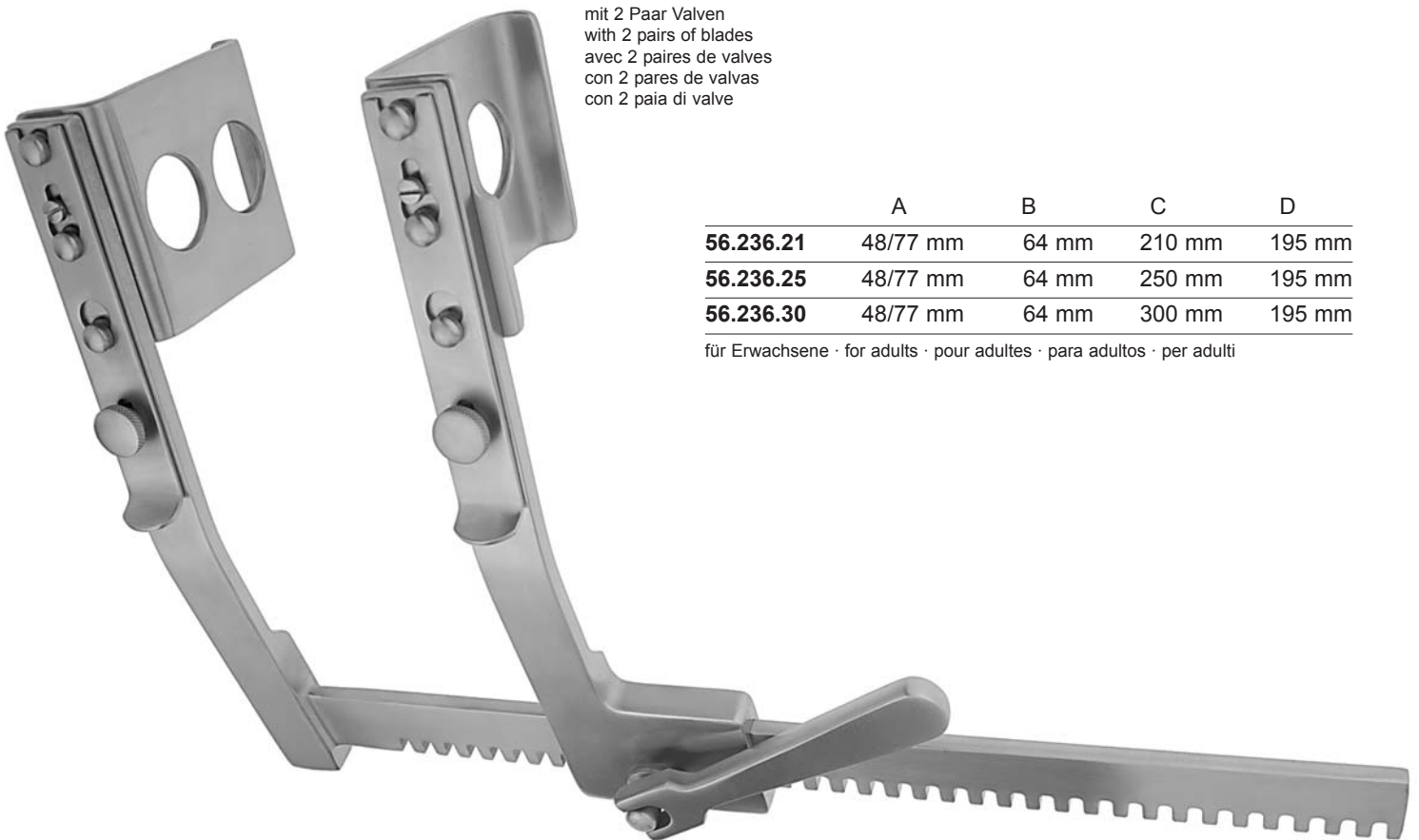
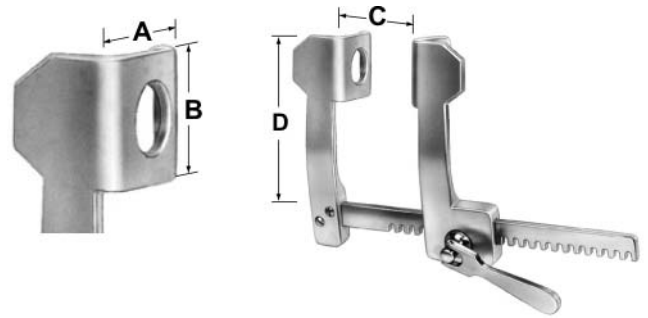

mit 2 Paar Valven  
 with 2 pairs of blades  
 avec 2 paires de valves  
 con 2 pares de valvas  
 con 2 paia di valve

	A	B	C	D
<b>56.236.21</b>	48/77 mm	64 mm	210 mm	195 mm
<b>56.236.25</b>	48/77 mm	64 mm	250 mm	195 mm
<b>56.236.30</b>	48/77 mm	64 mm	300 mm	195 mm

für Erwachsene · for adults · pour adultes · para adultos · per adulti

FINOCHIETTO BURFORD

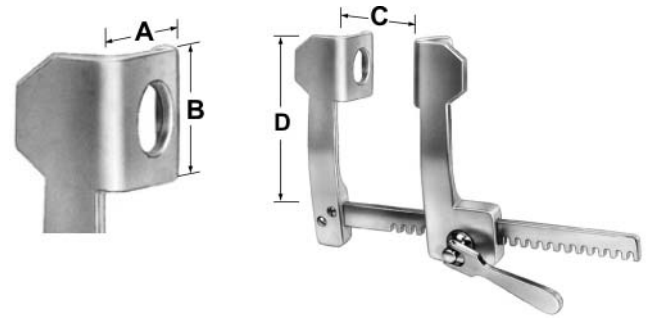

	C	D
<b>56.238.00</b>	150 mm	120 mm

für Kinder mit 3 Paar Valven 56.238.02 - 56.238.04 ·  
 for children with 3 pairs of blades 56.238.02 - 56.238.04 ·  
 pour enfants avec 3 paires de valves 56.238.02 - 56.238.04 ·  
 para niños con 3 pares de valvas 56.238.02 - 56.238.04 ·  
 per bambini con 3 paia di valve 56.238.02 - 56.238.04

	C	D
<b>56.238.01</b>	150 mm	120 mm

Sperrer allein · retractor only · ecarteur seul · separador suelto · divaricatore solo

DE BAKEY



**56.238.02**



**56.238.03**



**56.238.04**



**56.238.05**



**56.238.06**

	A	B
<b>56.238.02</b>	60 mm	60 mm
<b>56.238.03</b>	50 mm	80 mm
<b>56.238.04</b>	40 mm	100 mm
<b>56.238.05</b>	80 mm	60 mm
<b>56.238.06</b>	50 mm	66 mm

Paar Valven · pairs of blades · paires de valves · pares de valvas · paia di valve

Rippensperrer  
 Rib Spreaders  
 Ecarteurs des côtes  
 Separadores costales  
 Divaricatori costali

**dimeda**®

SURGICAL INSTRUMENTS

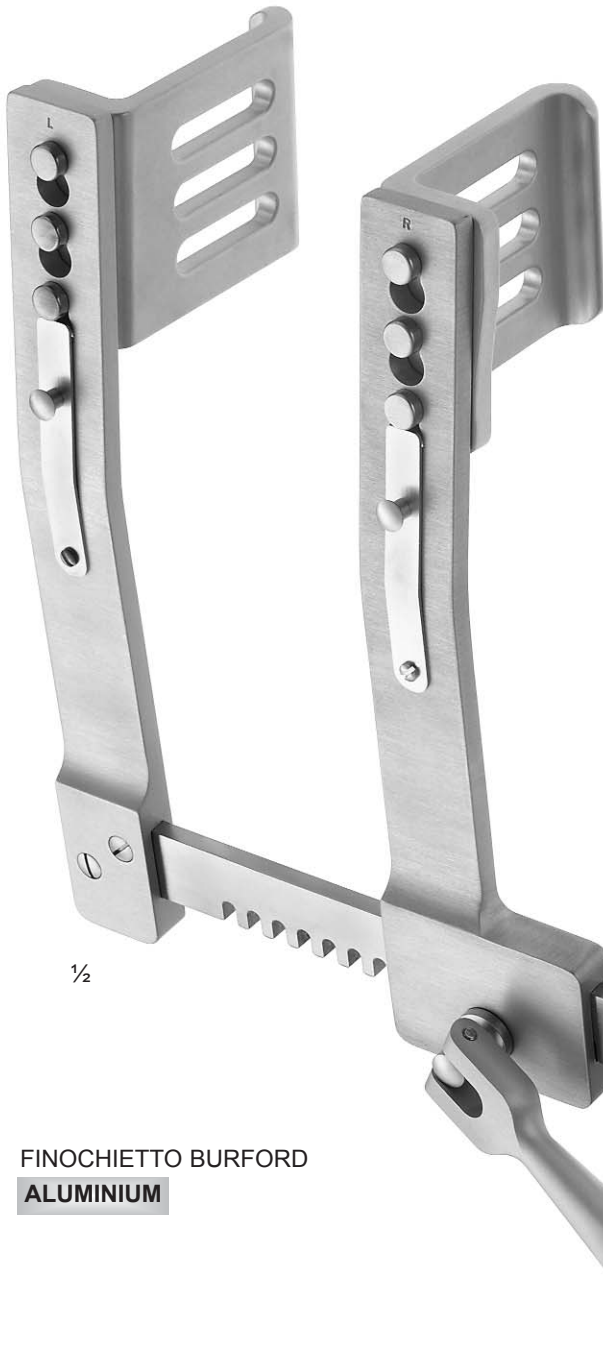
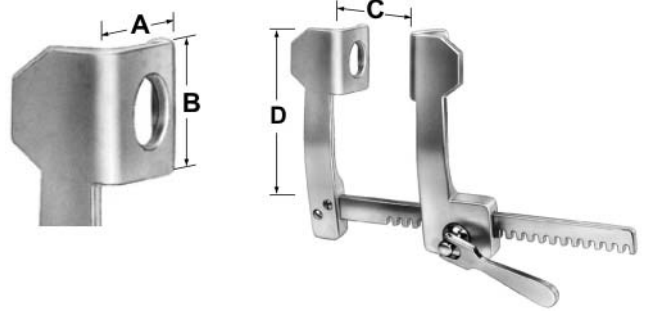

mit 2 Paar Valven  
 with 2 pairs of blades  
 avec 2 paires de valves  
 con 2 pares de valvas  
 con 2 paia di valve

	A	B	C	D
<b>56.242.18</b>	43/63 mm	61 mm	200 mm	200 mm
<b>56.242.26</b>	43/63 mm	61 mm	260 mm	200 mm
<b>56.242.30</b>	43/63 mm	61 mm	300 mm	200 mm

für Erwachsene · for adults · pour adultes · para adultos · per adulti

	A	B	C	D
<b>56.242.98</b>	43 mm	61 mm		
<b>56.242.26</b>	63 mm	61 mm		

Paar Valven · pairs of blades · paires de valves · pares de valvas · paia di valve

1/2

**FINOCHIETTO BURFORD**  
**ALUMINIUM**

Rippensperrer  
 Rib Spreaders  
 Ecarteurs des côtes  
 Separadores costales  
 Divaricatori costali

**dimeda**®

SURGICAL INSTRUMENTS

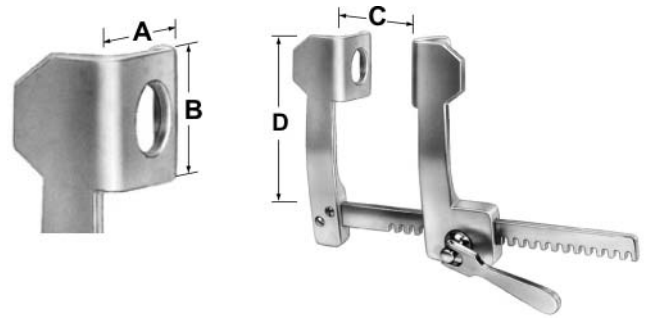

mit 2 Paar Valven  
 with 2 pairs of blades  
 avec 2 paires de valves  
 con 2 pares de valvas  
 con 2 paia di valve

	A	B	C	D
<b>56.244.18</b>	33/43 mm	43 mm	135 mm	118 mm

für Kinder · for children · pour enfants · para niños · per bambini

	A	B	C	D
<b>56.244.98</b>	33 mm	43 mm		
<b>56.244.26</b>	43 mm	43 mm		

Paar Valven · pairs of blades · paires de valves · pares de valvas · paia di valve

FINOCHIETTO BURFORD  
**ALUMINIUM**



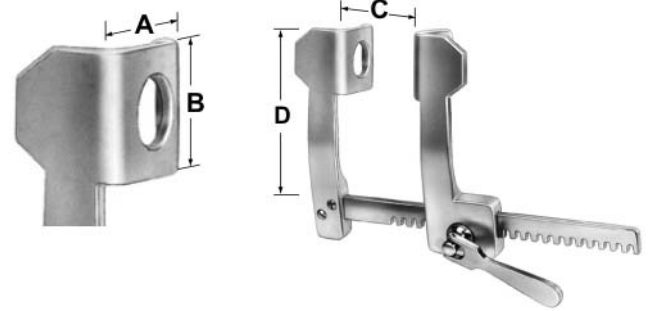

	A	B
<b>56.245.02</b>	40 mm	67 mm
<b>56.245.03</b>	80 mm	67 mm
<b>56.245.04</b>	30 mm	80 mm
<b>56.245.05</b>	25,5 mm	80 mm

Paar Valven · pairs of blades · paires de valves · pares de valvas · paia di valve

	C	D
<b>56.245.01</b>	220 mm	300 mm

für Erwachsene mit 2 Paar Valven 56.245.02 - 56.245.03 ·  
 for adults with 2 pairs of blades 56.245.02 - 56.245.03 ·  
 pour adultes avec 2 paires de valves 56.245.02 - 56.245.03 ·  
 para adultos con 2 pares de valvas 56.245.02 - 56.245.03 ·  
 per adulti con 2 paia di valve 56.245.02 - 56.245.03



Rippensperrer  
 Rib Spreaders  
 Ecarteurs des côtes  
 Separadores costales  
 Divaricatori costali

**dimeda**®

SURGICAL INSTRUMENTS

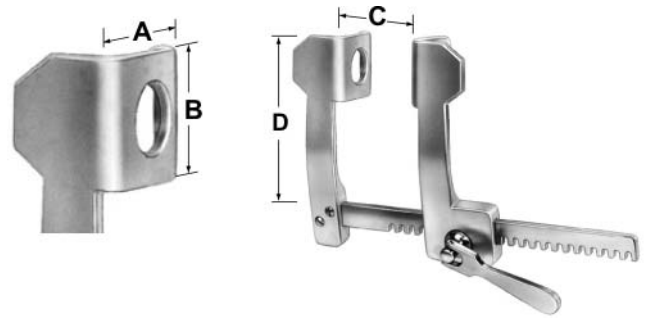

**CASTAÑEDA**  
**ALUMINIUM**

	A	B	C	D
<b>56.250.06</b>	9 mm	34 mm	70 mm	55 mm
für Neugeborene · neonatal · néonatal · neonatal · neonatale				

	A	B	C	D
<b>56.250.07</b>	11 mm	45 mm	80 mm	80 mm
für Säuglinge · for babies · pour bébé · para bebés · per neonati				

	A	B	C	D
<b>56.250.12</b>	15 mm	60 mm	120 mm	125 mm
für Kinder · for children · pour enfants · para niños · per bambini				



**WEINBERG**  
**ALUMINIUM**

	A	B	C	D
<b>56.251.01</b>	12 mm	20 mm	95 mm	75 mm
für Kinder · for children · pour enfants · para niños · per bambini				

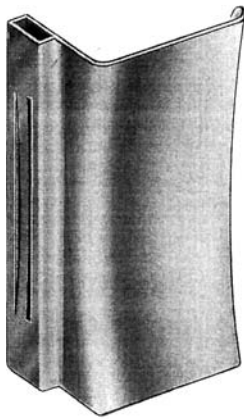

56.256.11

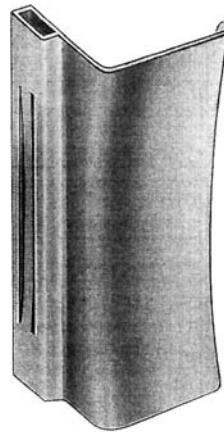
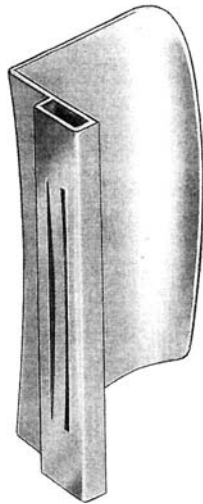

56.256.12

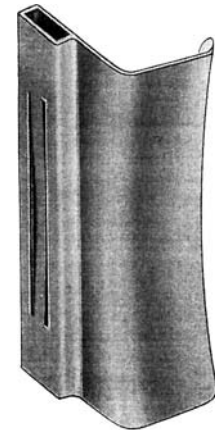
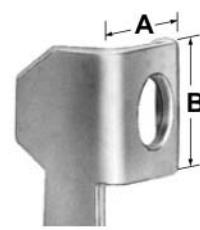

56.256.13

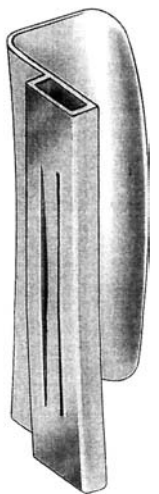
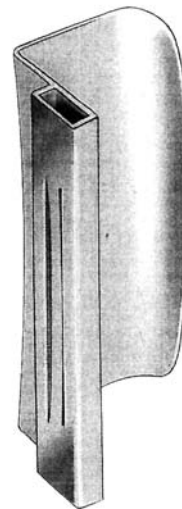

A B

56.256.11 40 mm 100 mm

56.256.12 50 mm 100 mm

56.256.13 60 mm 100 mm

Paar Valven · pairs of blades · paires de valves · pares de valvas · paia di valve

C D

56.256.00 160 mm 160 mm

für Erwachsene mit 3 Paar Valven 56.256.11 - 56.256.13 ·  
 for adults with 3 pairs of blades 56.256.11 - 56.256.13 ·  
 pour adultes avec 3 paires de valves 56.256.11 - 56.256.13 ·  
 para adultos con 3 pares de valvas 56.256.11 - 56.256.13 ·  
 per adulti con 3 paia di valve 56.256.11 - 56.256.13

C D

56.256.01 160 mm 160 mm

Sperrer allein · retractor only · ecarteur seul · separador suelto · divaricatore solo

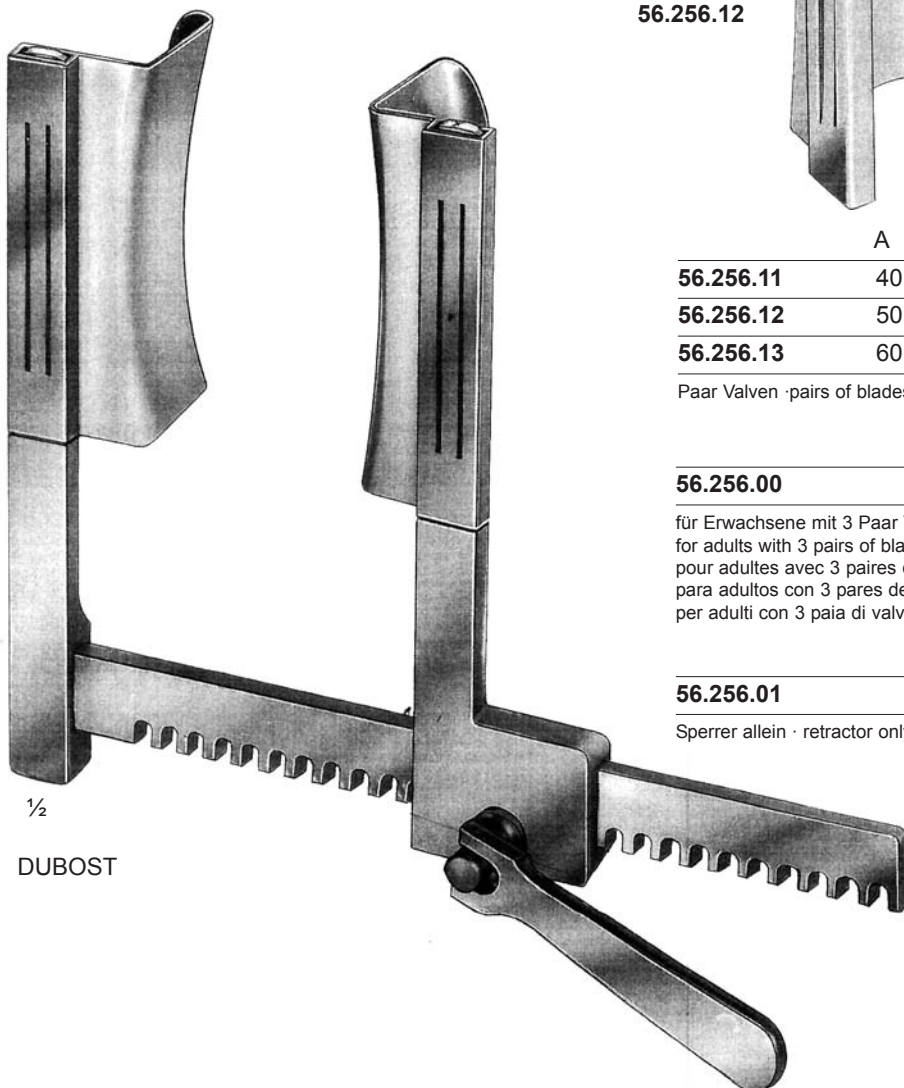

1/2

DUBOST

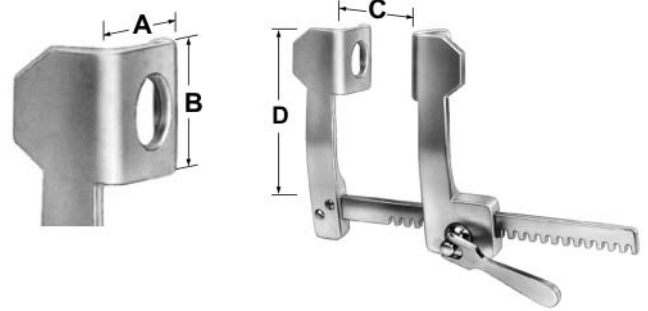

STRUCK

	C	D
<b>56.258.00</b>	70 mm	64 mm

für Kleinkinder mit 2 Paar Valven 56.258.14 - 56.258.15 ·  
 for infants with 2 pairs of blades 56.258.14 - 56.258.15 ·  
 pour enfants avec 2 paires de valves 56.258.14 - 56.258.15 ·  
 para niños con 2 pares de valvas 56.258.14 - 56.258.15 ·  
 per bambini con 2 paia di valve 56.258.14 - 56.258.15

	C	D
<b>56.258.01</b>	70 mm	64 mm

Sperrer allein · retractor only · ecarteur seul · separador suelto · divaricatore solo



**56.258.11**



**56.258.12**



**56.258.13**



**56.258.14**



**56.258.15**

	A	B
<b>56.258.11</b>	10 mm	10 mm
<b>56.258.12</b>	10 mm	15 mm
<b>56.258.13</b>	10 mm	20 mm
<b>56.258.14</b>	15 mm	20 mm
<b>56.258.15</b>	20 mm	20 mm

Paar Valven · pairs of blades · paires de valves · pares de valvas · paia di valve

Rippensperrer  
 Rib Spreaders  
 Ecarteurs des côtes  
 Separadores costales  
 Divaricatori costali

**dimeda**<sup>®</sup>

SURGICAL INSTRUMENTS

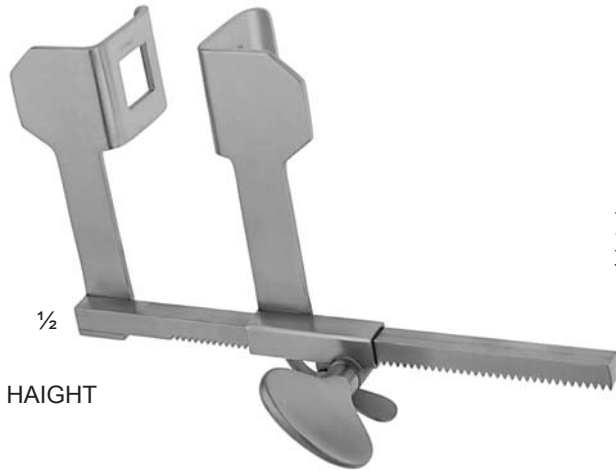
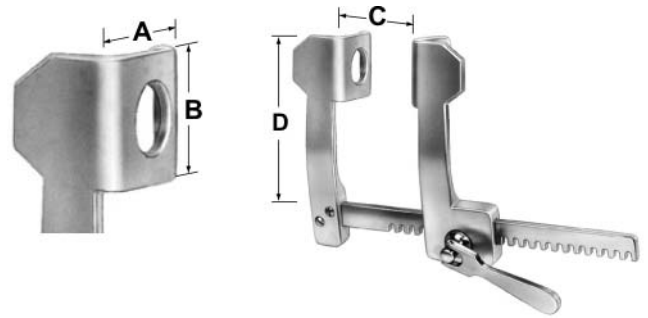

HAIGHT

	A	B	C	D
<b>56.260.09</b>	30 mm	30 mm	90 mm	70 mm
für Kinder · for children · pour enfants · para niños · per bambini				

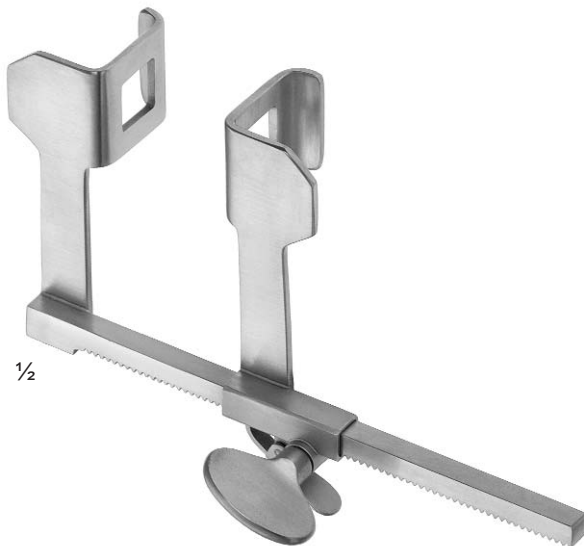

HAIGHT

	A	B	C	D
<b>56.260.15</b>	30 mm	30 mm	115 mm	90 mm
für Kinder · for children · pour enfants · para niños · per bambini				

Rippensperrer  
 Rib Spreaders  
 Ecarteurs des côtes  
 Separadores costales  
 Divaricatori costali

**dimeda**<sup>®</sup>

SURGICAL INSTRUMENTS

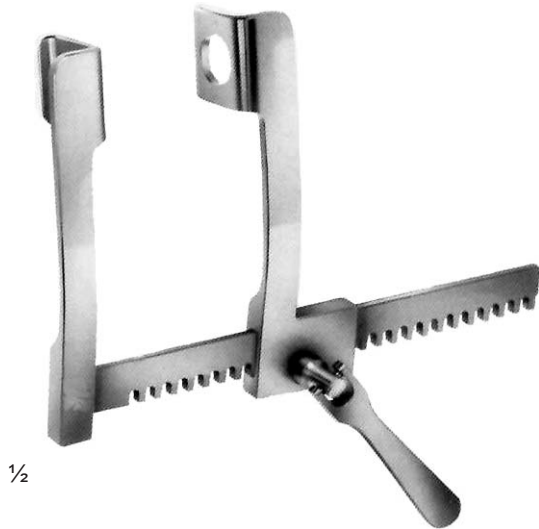
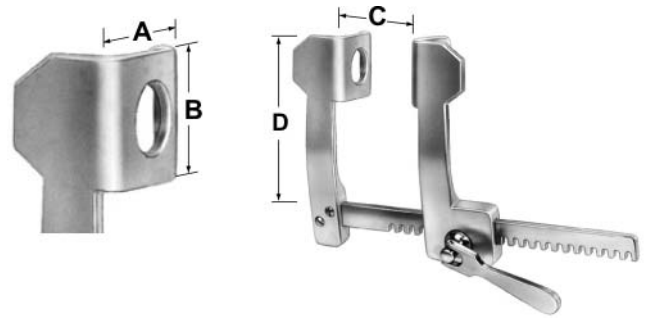

	A	B	C	D
<b>56.262.12</b>	28 mm	32 mm	120 mm	140 mm

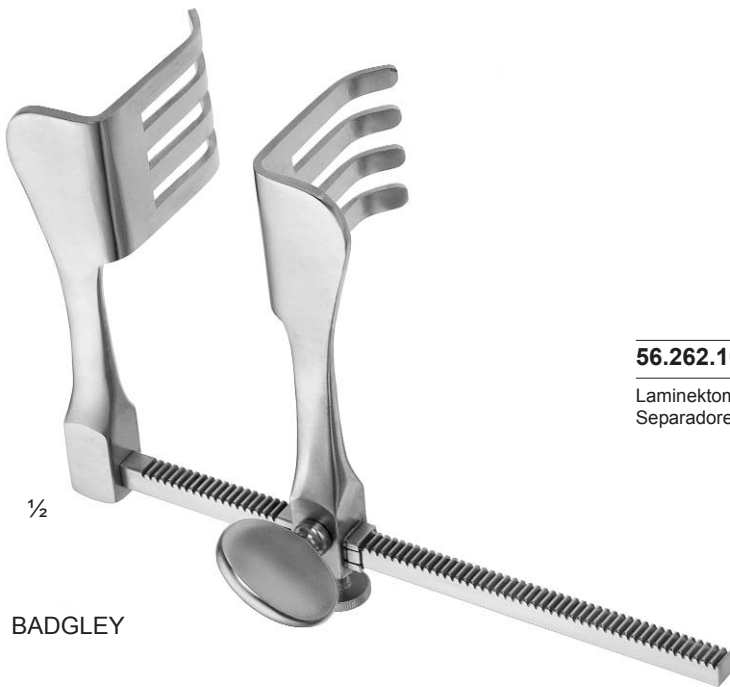

	A	B	C	D
<b>56.262.16</b>	48 mm	45 mm	170 mm	110 mm

Laminektomie-Spreizer · Laminectomy Spreader · Ecarteurs pour laminectomie · Separadores para laminectomia · Divaricatori per laminectomia

BADGLEY

Rippensperrer  
 Rib Spreaders  
 Ecarteurs des côtes  
 Separadores costales  
 Divaricatori costali

**dimeda**<sup>®</sup>

SURGICAL INSTRUMENTS

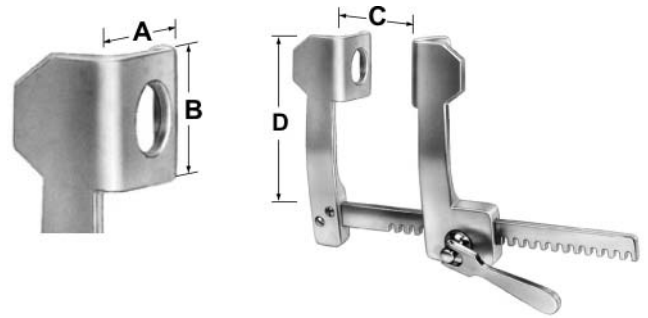

1/2

TUFFIER

	A	B	C	D
<b>56.264.14</b>	32 mm	19 mm	145 mm	90 mm
für Kinder · for children · pour enfants · para niños · per bambini				



1/2

TUFFIER

	A	B	C	D
<b>56.264.16</b>	50 mm	45 mm	165 mm	110 mm
für Kinder · for children · pour enfants · para niños · per bambini				





**56.266.30**



**56.266.40**



**56.266.50**



**56.266.66**

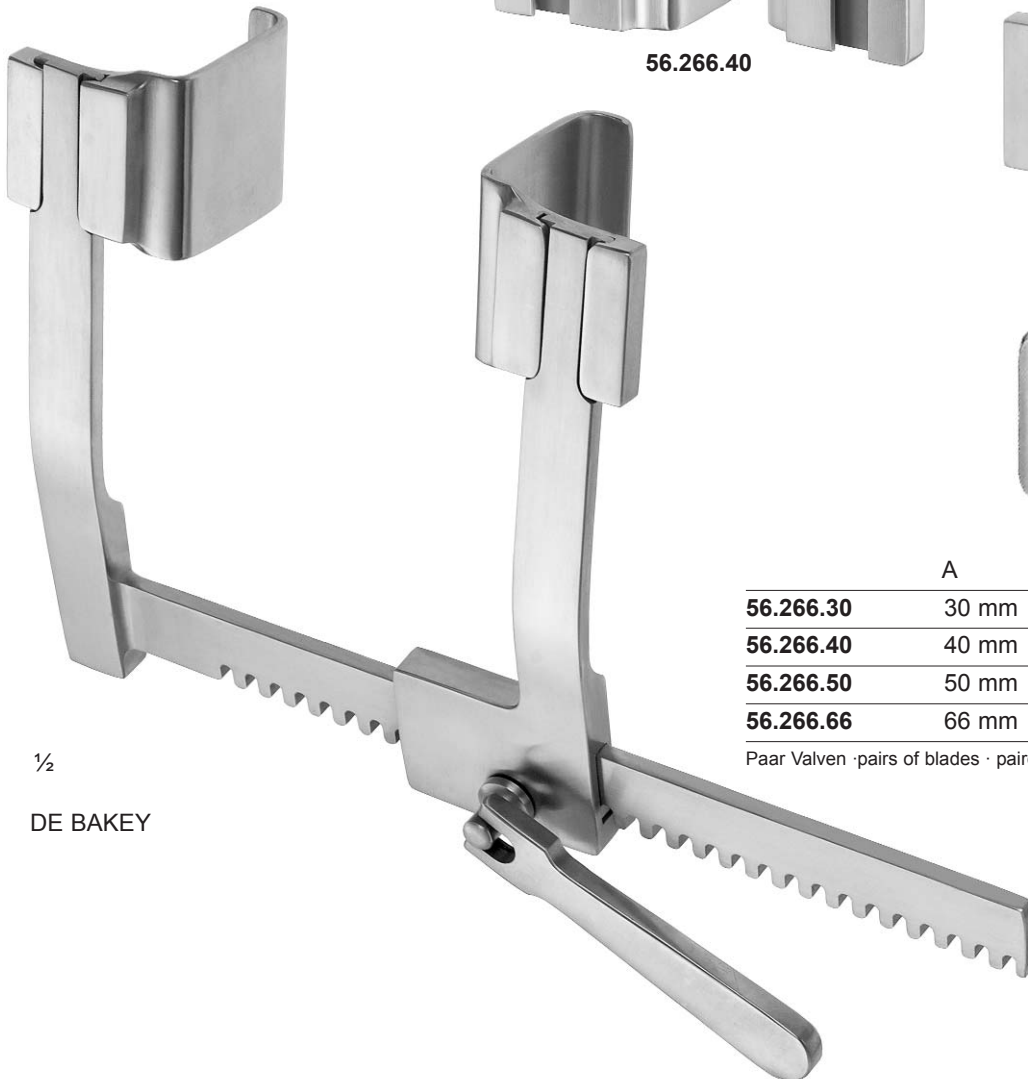

1/2

DE BAKEY



	A	B
<b>56.266.30</b>	30 mm	30 mm
<b>56.266.40</b>	40 mm	40 mm
<b>56.266.50</b>	50 mm	50 mm
<b>56.266.66</b>	66 mm	66 mm

Paar Valven · pairs of blades · paires de valves · pares de valvas · paia di valve

	C	D
<b>56.266.00</b>	150 mm	180 mm

für Erwachsene mit 3 Paar Valven 56.266.30, 56.266.40 & 56.266.50 ·  
 for adults with 3 pairs of blades 56.266.30, 56.266.40 & 56.266.50 ·  
 pour adultes avec 3 paires de valves 56.266.30, 56.266.40 & 56.266.50 ·  
 para adultos con 3 pares de valvas 56.266.30, 56.266.40 & 56.266.50 ·  
 per adulti con 3 paia di valve 56.266.30, 56.266.40 & 56.266.50

	C	D
<b>56.266.09</b>	150 mm	180 mm

Sperrer allein · retractor only · ecarteur seul · separador suelto · divaricatore solo



56.268.40



56.268.66

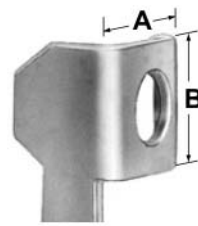

56.268.50

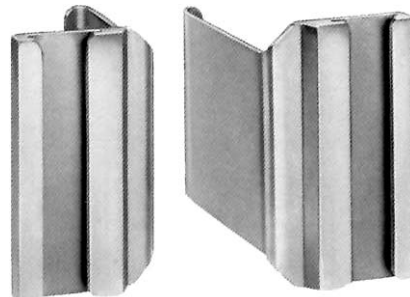

56.268.60



56.268.80



	A	B
56.268.40	40 mm	100 mm
56.268.50	50 mm	80 mm
56.268.60	60 mm	60 mm
56.268.66	66 mm	66 mm
56.268.80	80 mm	60 mm

Paar Valven · pairs of blades · paires de valves · pares de valvas · paia di valve

	C	D
56.268.00	200 mm	225 mm

für Erwachsene mit 3 Paar Valven 56.268.40, 56.268.50 & 56.268.60 ·  
 for adults with 3 pairs of blades 56.268.40, 56.268.50 & 56.268.60 ·  
 pour adultes avec 3 paires de valves 56.268.40, 56.268.50 & 56.268.60 ·  
 para adultos con 3 pares de valvas 56.268.40, 56.268.50 & 56.268.60 ·  
 per adulti con 3 paia di valve 56.268.40, 56.268.50 & 56.268.60

	C	D
56.268.22	200 mm	225 mm

Sperrer allein · retractor only · ecarteur seul · separador suelto · divaricatore solo



Rippensperrer  
 Rib Spreaders  
 Ecarteurs des côtes  
 Separadores costales  
 Divaricatori costali

**dimeda**<sup>®</sup>

SURGICAL INSTRUMENTS

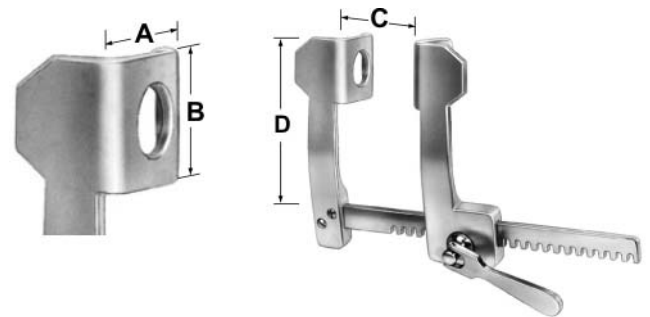

**56.270.48**



**56.270.70**

**56.270.00**

mit 2 Paar Valven 56.270.48 & 56.270.70 ·  
 with 2 pairs of blades 56.270.48 & 56.270.70 ·  
 avec 2 paires de valves 56.270.48 & 56.270.70 ·  
 con 2 pares de valvas 56.270.48 & 56.270.70 ·  
 con 2 paia di valve 56.270.48 & 56.270.70

**56.270.10**

Sperrer allein · retractor only · ecarteur seul · separador suelto · divaricatore solo

	A	B
<b>56.270.48</b>	48 mm	68 mm
<b>56.270.70</b>	70 mm	75 mm

Paar Valven · pairs of blades · paires de valves · pares de valvas · paia di valve

1/2

MERCEDES

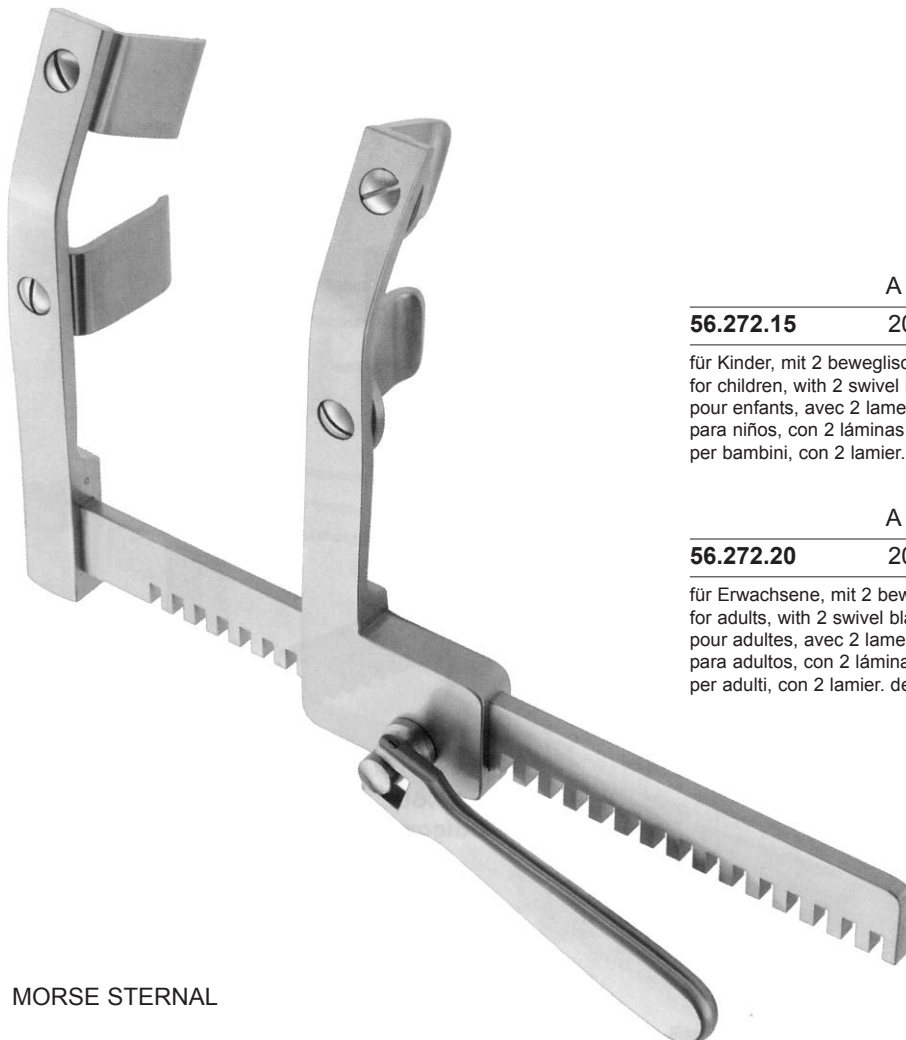
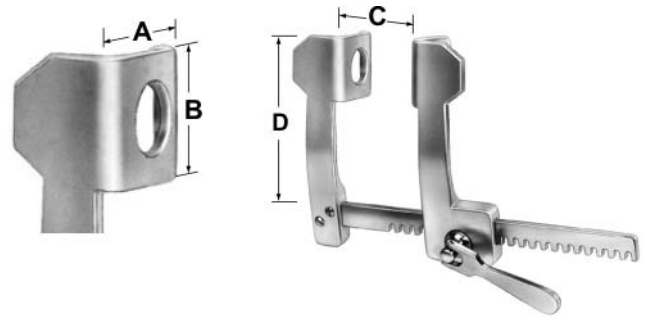

	A	B	C	D
<b>56.272.15</b>	20 mm	20 mm	160 mm	120 mm

für Kinder, mit 2 beweglichen Valven 50 mm einzeln ·  
 for children, with 2 swivel blades 50 mm apart ·  
 pour enfants, avec 2 lames de pivot 50 mm à part ·  
 para niños, con 2 láminas del eslabón giratorio 50 mm ·  
 per bambini, con 2 lamier. della parte girevole 50 mm

	A	B	C	D
<b>56.272.20</b>	20 mm	28 mm	200 mm	150 mm

für Erwachsene, mit 2 beweglichen Valven 72 mm einzeln ·  
 for adults, with 2 swivel blades 72 mm apart ·  
 pour adultes, avec 2 lames de pivot 72 mm à part ·  
 para adultos, con 2 láminas del eslabón giratorio 72 mm ·  
 per adulti, con 2 lamier. della parte girevole 72 mm

MORSE STERNAL

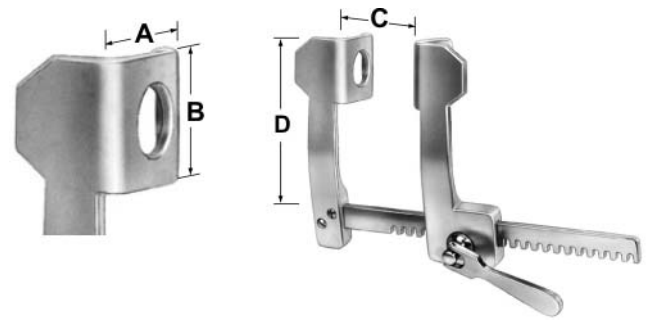

FAVOLORO	A	B	C	D
<b>56.273.16</b>	17 mm	22 mm	160 mm	120 mm

für Kinder, mit 2 beweglichen Valven 50 mm einzeln ·  
 for children, with 2 swivel blades 50 mm apart ·  
 pour enfants, avec 2 lames de pivot 50 mm à part ·  
 para niños, con 2 láminas del eslabón giratorio 50 mm ·  
 per bambini, con 2 lamier. della parte girevole 50 mm

FAVOLORO	A	B	C	D
<b>56.273.15</b>	40 mm	20 mm	155 mm	175 mm

für Erwachsene, mit 2 beweglichen Valven 65 mm einzeln ·  
 for adults, with 2 swivel blades 65 mm apart ·  
 pour adultes, avec 2 lames de pivot 65 mm à part ·  
 para adultos, con 2 láminas del eslabón giratorio 65 mm ·  
 per adulti, con 2 lamier. della parte girevole 65 mm

	A	B	C	D
<b>56.273.20</b>	20 mm	20 mm	155 mm	120 mm

für Kinder, mit 2 beweglichen Valven 50 mm einzeln ·  
 for children, with 2 swivel blades 50 mm apart ·  
 pour enfants, avec 2 lames de pivot 50 mm à part ·  
 para niños, con 2 láminas del eslabón giratorio 50 mm ·  
 per bambini, con 2 lamier. della parte girevole 50 mm

	A	B	C	D
<b>56.273.19</b>	40 mm	28 mm	210 mm	155 mm

für Erwachsene, mit 2 beweglichen Valven 72 mm einzeln ·  
 for adults, with 2 swivel blades 72 mm apart ·  
 pour adultes, avec 2 lames de pivot 72 mm à part ·  
 para adultos, con 2 láminas del eslabón giratorio 72 mm ·  
 per adulti, con 2 lamier. della parte girevole 72 mm

	A	B	C	D
<b>56.273.30</b>	40 mm	28 mm	210 mm	155 mm

für Erwachsene, mit 3 beweglichen Valven 42 mm einzeln ·  
 for adults, with 3 swivel blades 42 mm apart ·  
 pour adultes, avec 3 lames de pivot 42 mm à part ·  
 para adultos, con 3 láminas del eslabón giratorio 42 mm ·  
 per adulti, con 3 lamier. della parte girevole 42 mm

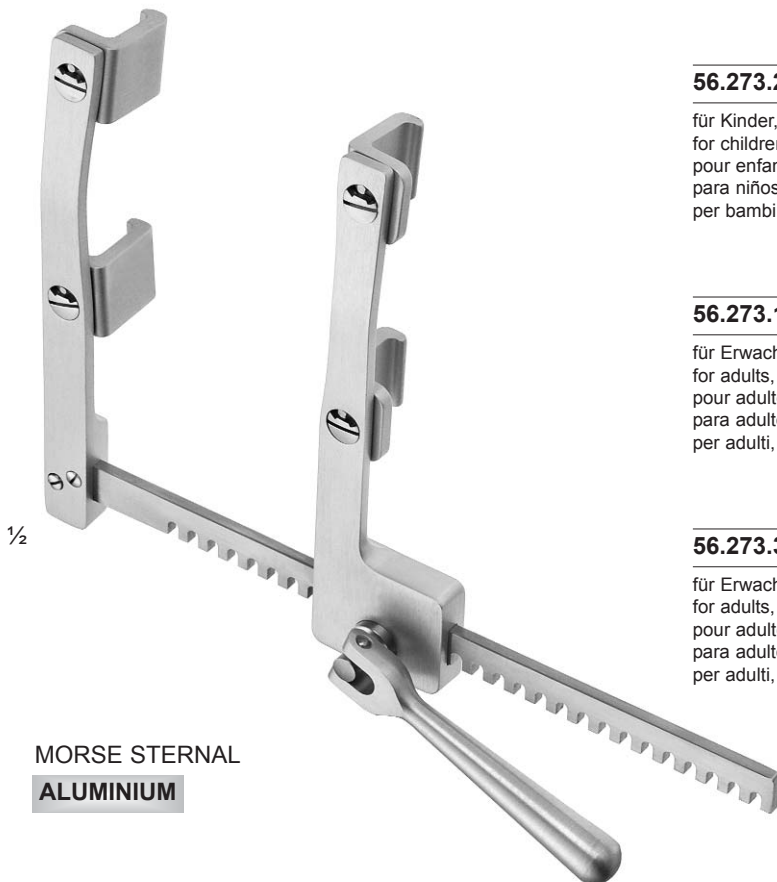

MORSE STERNAL  
**ALUMINIUM**

Rippensperrer  
 Rib Spreaders  
 Ecarteurs des côtes  
 Separadores costales  
 Divaricatori costali

**dimeda**<sup>®</sup>

SURGICAL INSTRUMENTS

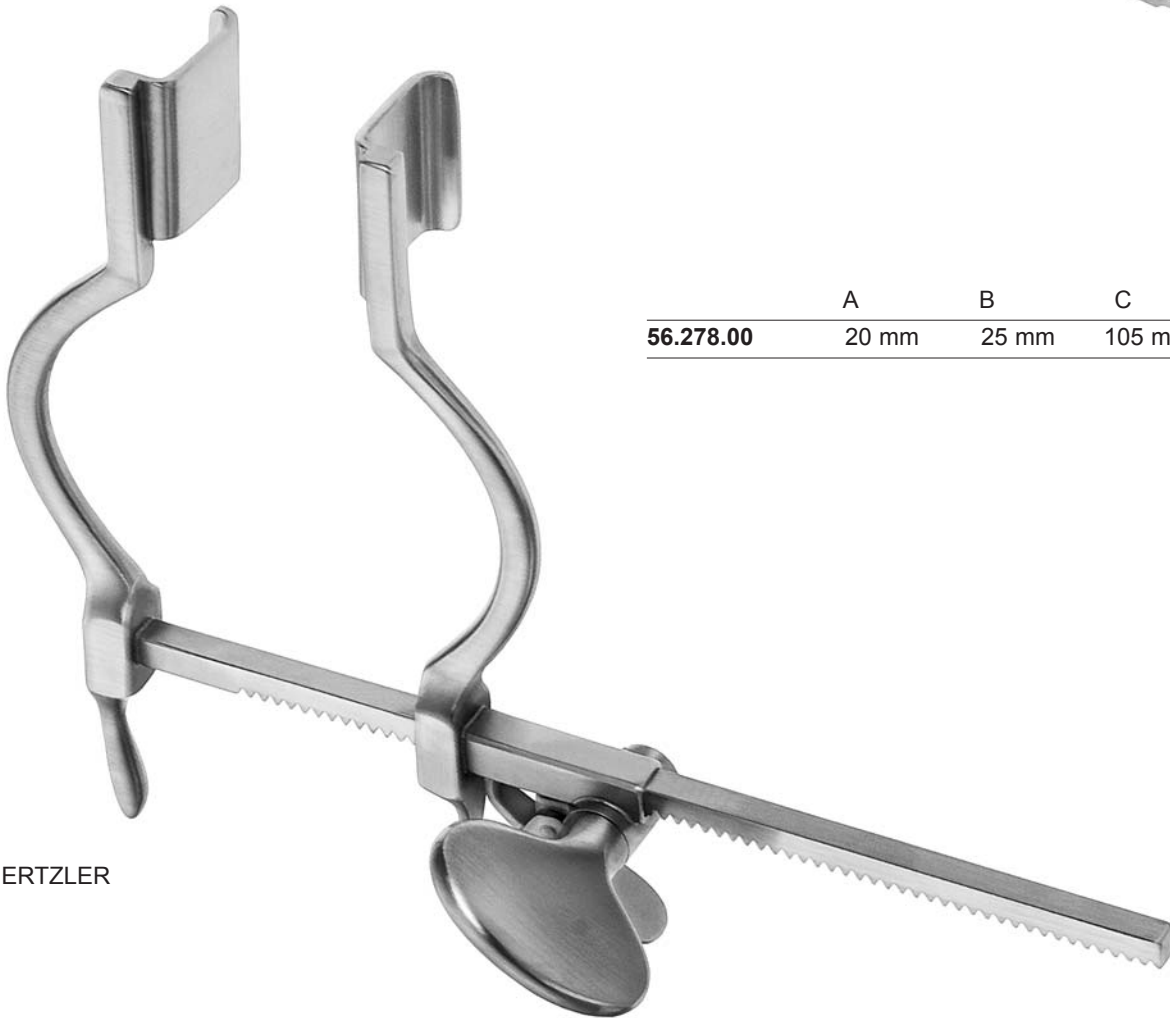
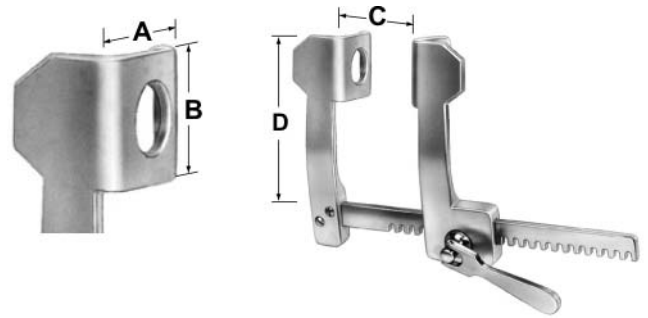

	A	B	C	D
<b>56.278.00</b>	20 mm	25 mm	105 mm	90 mm

HERTZLER



Sonden, Dilatatoren  
Probes, Dilators  
Sondes, Dilatateurs  
Sondas, Dilatadores  
Sonde, Dilatatori

**NABATOFF**  
**20.150.00**

- krampfader-Besteck, komplett, bestehend aus:
- 20.150.02** 1 Kunststoff-Sondenspitze
  - 20.150.03** 1 Metall-Sondenspitze, ø 3 mm
  - 20.150.06** 1 Metallolive, ø 6 mm
  - 20.150.09** 1 Metallolive, ø 9 mm
  - 20.150.12** 1 Metallolive, ø 12 mm
  - 20.150.15** 1 Metallolive, ø 15 mm
  - 20.150.80** 1 Handgriff
  - 20.150.90** 1 Zugseil, 90 cm lang
  - 20.150.99** 1 Ovale Metallkoffer

- Varicose vein probe set, complete, consisting of:
- 20.150.02** 1 Plastic probe tip
  - 20.150.03** 1 Metal probe tip, ø 3 mm
  - 20.150.06** 1 Metal olive, ø 6 mm
  - 20.150.09** 1 Metal olive, ø 9 mm
  - 20.150.12** 1 Metal olive, ø 12 mm
  - 20.150.15** 1 Metal olive, ø 15 mm
  - 20.150.80** 1 Handle
  - 20.150.90** 1 flexible cable, 90 cm
  - 20.150.99** 1 Oval metal case

- Trousse à varices, complète, composée de:
- 20.150.02** 1 Pointe plastique
  - 20.150.03** 1 Pointe métallique, ø 3 mm
  - 20.150.06** 1 Olive métallique, ø 6 mm
  - 20.150.09** 1 Olive métallique, ø 9 mm
  - 20.150.12** 1 Olive métallique, ø 12 mm
  - 20.150.15** 1 Olive métallique, ø 15 mm
  - 20.150.80** 1 Manche
  - 20.150.90** 1 Cable tracteur, flexible, 90 cm
  - 20.150.99** 1 Boîte métal, ovale

- Juego para várices, completo, compuesto de:
- 20.150.02** 1 Extremidad de sonda de plástico
  - 20.150.03** 1 Extremidad de sonda de metal, ø 3 mm
  - 20.150.06** 1 Oliva de metal, ø 6 mm
  - 20.150.09** 1 Oliva de metal, ø 9 mm
  - 20.150.12** 1 Oliva de metal, ø 12 mm
  - 20.150.15** 1 Oliva de metal, ø 15 mm
  - 20.150.80** 1 Mango
  - 20.150.90** 1 Cable tracción, 90 cm
  - 20.150.99** 1 Caja metálica oval

- Astuccio per varici, completo, composto da:
- 20.150.02** 1 Punta in materia plastica
  - 20.150.03** 1 Punta in materia metallo, ø 3 mm
  - 20.150.06** 1 Oliva in materia metallo, ø 6 mm
  - 20.150.09** 1 Oliva in materia metallo, ø 9 mm
  - 20.150.12** 1 Oliva in materia metallo, ø 12 mm
  - 20.150.15** 1 Oliva in materia metallo, ø 15 mm
  - 20.150.80** 1 Manica
  - 20.150.90** 1 Cavo di trazione, flessibile, 90 cm
  - 20.150.99** 1 Scatola metallica ovale



**NABATOFF**  
**20.150.00**  
 135 x 100 x 25 mm



**20.150.90**  
 90 cm/36"



**20.150.02**



**20.150.03**  
 ø 3 mm



**20.150.06**  
 ø 6 mm



**20.150.09**  
 ø 9 mm



**20.150.12**  
 ø 12 mm



**20.150.15**  
 ø 15 mm



**20.150.80**

**VARADY**  
**20.151.00**

krampfader-Besteck, komplett, bestehend aus:

- 20.151.03** 1 Metallolive, ø 3 mm
- 20.151.04** 1 Metallolive, ø 4 mm
- 20.151.05** 1 Metallolive, ø 5 mm
- 20.151.90** 1 Zugseil, 45 cm lang, Kunststoffummantelt
- 20.151.99** 1 Ovalem Metalltuetie

Varicose vein probe set, complete, consisting of:

- 20.151.03** 1 Metal olive, ø 3 mm
- 20.151.04** 1 Metal olive, ø 4 mm
- 20.151.05** 1 Metal olive, ø 5 mm
- 20.151.90** 1 Flexible cable, 45 cm/17½" long, polyethylene coating
- 20.151.99** 1 Oval metal case

Trousse à varices, complète, composée de:

- 20.151.03** 1 Olive métallique, ø 3 mm
- 20.151.04** 1 Olive métallique, ø 4 mm
- 20.151.05** 1 Olive métallique, ø 5 mm
- 20.151.90** 1 Cable tracteur, flexible, 45 cm
- 20.151.99** 1 Boîte métal, ovale

Juego para várices, completo, compuesto de:

- 20.151.03** 1 Oliva de metal, ø 3 mm
- 20.151.04** 1 Oliva de metal, ø 4 mm
- 20.151.05** 1 Oliva de metal, ø 5 mm
- 20.151.90** 1 Cable traccion, 45 cm
- 20.151.99** 1 Caja metálica oval

Astuccio per varici, completo, composto da:

- 20.151.03** 1 Oliva in materia metallo, ø 3 mm
- 20.151.04** 1 Oliva in materia metallo, ø 4 mm
- 20.151.05** 1 Oliva in materia metallo, ø 5 mm
- 20.151.90** 1 Cavo di trazione, flessibile, 45 cm
- 20.151.99** 1 Scatola metallica ovale



1/2

**VARADY**  
**20.151.00**



**20.151.03**  
 Ø 3 mm



**20.151.04**  
 Ø 4 mm



**20.151.05**  
 Ø 5 mm



**20.151.90**  
 45 cm/17½"



○  
**20.160.02**  
ø 2 mm

○  
**20.160.03**  
ø 3 mm

○  
**20.160.04**  
ø 4 mm

○  
**20.160.06**  
ø 6 mm

○  
**20.160.07**  
ø 7 mm

○  
**20.160.08**  
ø 8.5 mm

○  
**20.160.10**  
ø 10 mm

○  
**20.160.12**  
ø 12 mm

○  
**20.160.14**  
ø 14 mm



VOLLMAR  
**20.162.12**  
12 cm/4 1/4"

Handgriff für Ringstripper  
Handle for Ring Stripper  
Manche pour stripper à anneau  
mango para fleboextractor  
Manico per stripper anello



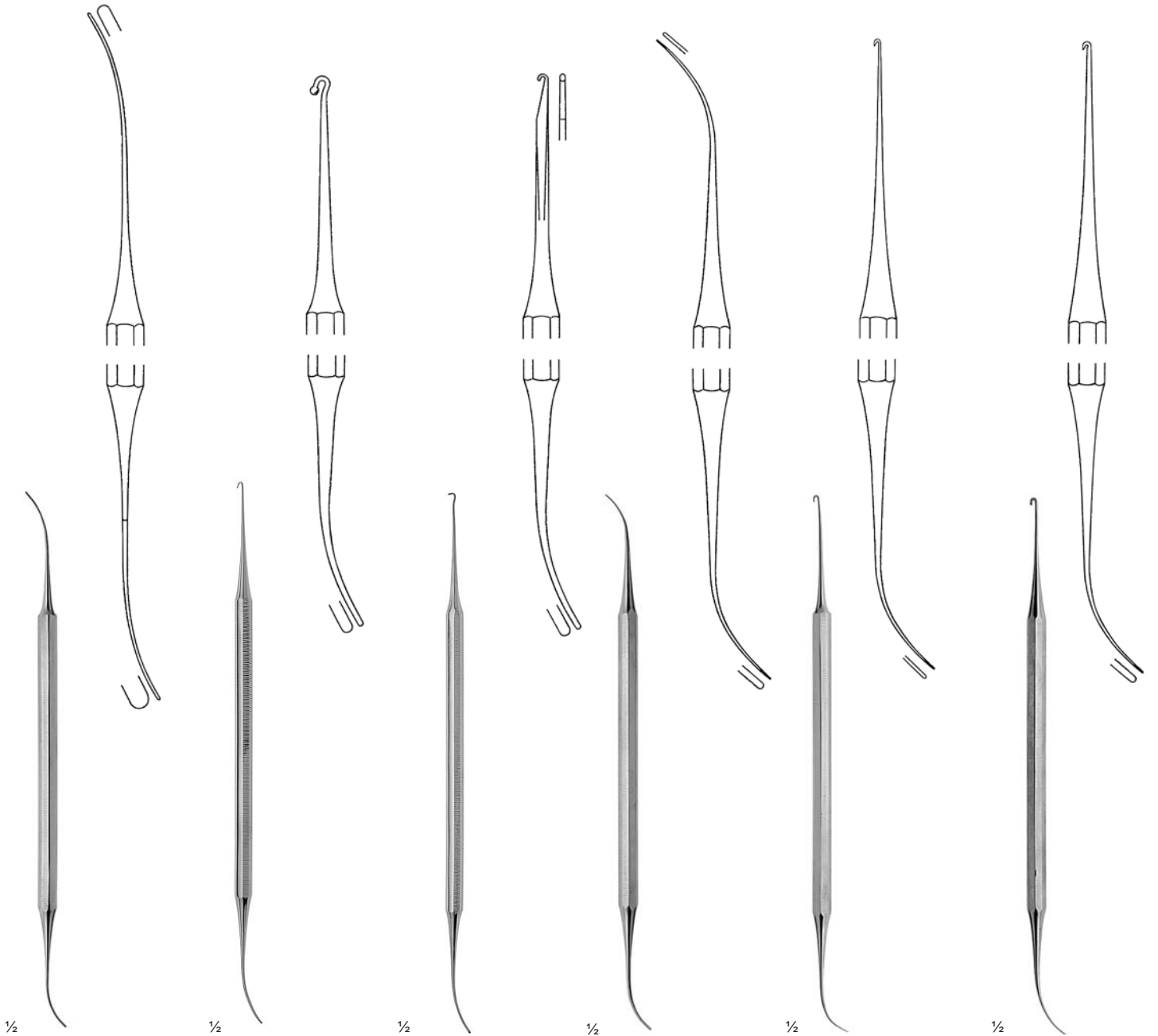

VARADY  
**20.167.01**  
 18 cm/7"

Phlebodissektor  
 Phlebodisector  
 Phlebodissecteur  
 Flebodisecador  
 Flebodissettore

VARADY  
**20.167.02**  
 18 cm/7"

Phleboextraktor  
 Phleboextractor  
 Phleboextracteur  
 Fleboextractor  
 Fleboestrattore

VARADY  
**20.167.03**  
 18 cm/7"

Phleboextraktor  
 Phleboextractor  
 Phleboextracteur  
 Fleboextractor  
 Fleboestrattore

VARADY  
**20.167.04**  
 18 cm/7"

Mikro-Dissektor  
 Micro Dissector  
 Micro dissecteur  
 Micro disecador  
 Micro-dissettore

VARADY  
**20.167.05**  
 18 cm/7"

Mikro-Phleboextraktor  
 Micro-Phleboextractor  
 Micro-Phleboextracteur  
 Micro-Fleboextractor  
 Micro-Fleboestrattore

VARADY  
**20.167.06**  
 18 cm/7"

Mini-Phleboextraktor  
 Mini-Phleboextractor  
 Mini-Phleboextracteur  
 Mini-Fleboextractor  
 Mini-Fleboestrattore

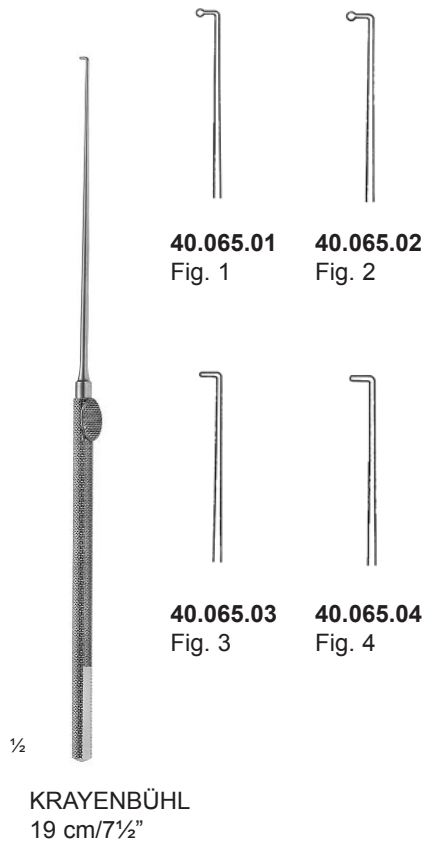
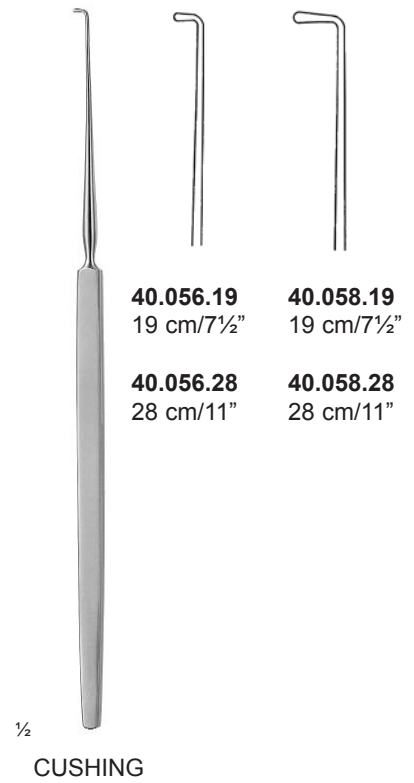

Nervhäkchen, Duradisektoren  
 Nerve hooks, Dura dissectors  
 Crochets à nerfs, Dissecteurs à dure-mère  
 Ganchito para nervios, Disecadores para duramadre  
 Uncini per nervi, Dissettori per la dura-madre

**dimed**<sup>®</sup>

SURGICAL INSTRUMENTS

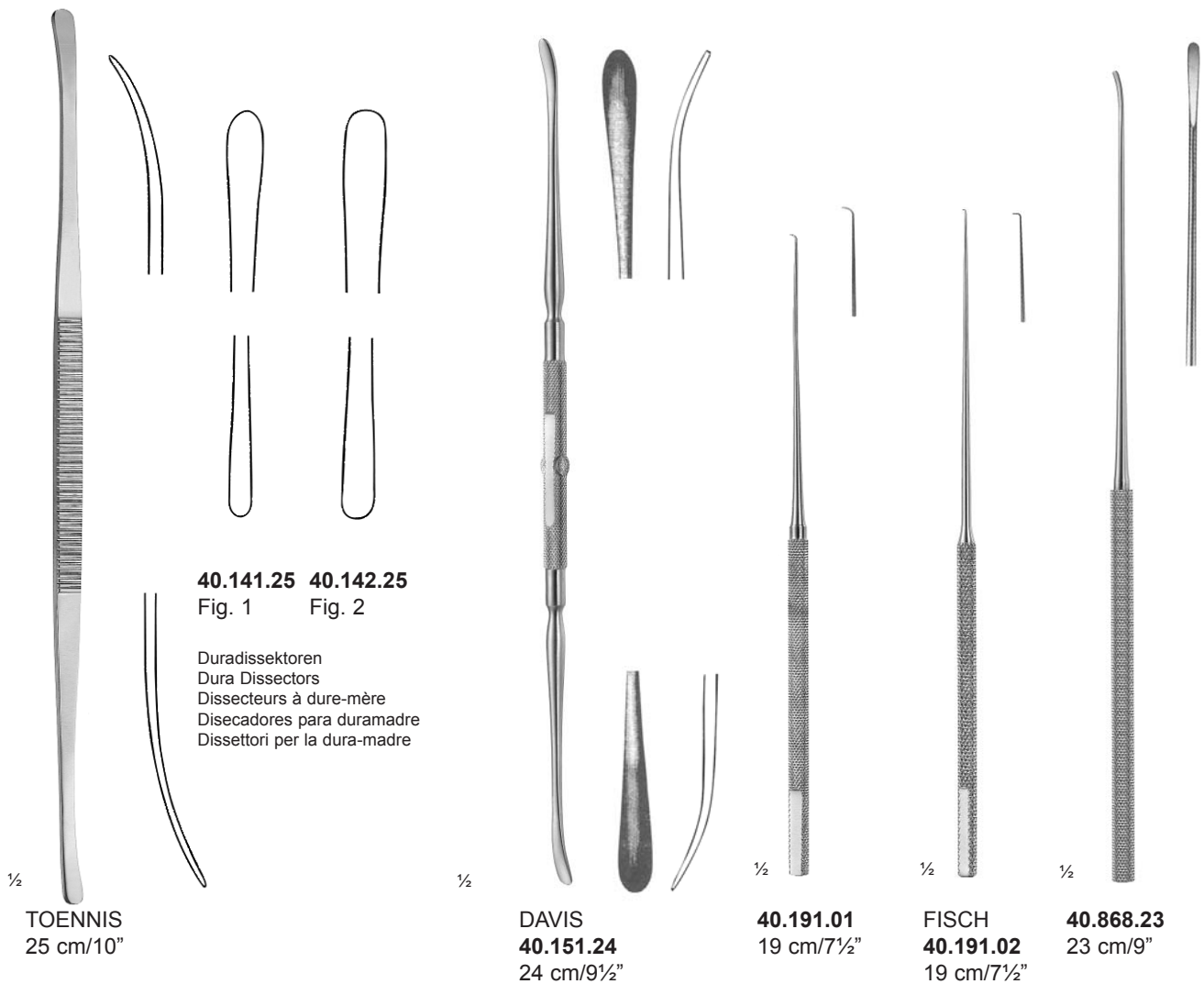

Irisspatel, Septumlevatorium, Häckchen  
 Iris Spatula, Septum elevators, Hooklets  
 Spatule pour l'iris, Elévateurs pour cloison, erignes  
 Espatula para iris, Elevadores para tabique, ganchitos  
 spatola per iride, Elevatori per setto, Uncini

**dimeda**®

SURGICAL INSTRUMENTS

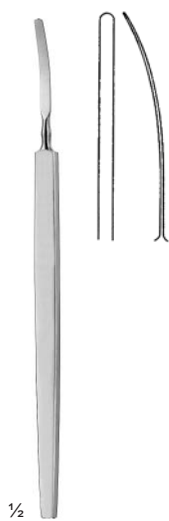

½  
**WECKER**  
**42.461.13**  
 12,5 cm/5"



½  
**WECKER**  
**42.462.13**  
 12,5 cm/5"

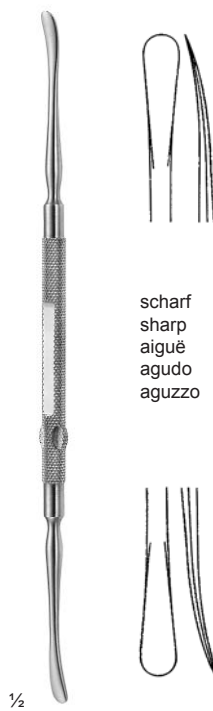

½  
**FREER**  
**46.415.18**  
 18 cm/7"  
 5 / 5 mm

scharf  
 sharp  
 aiguë  
 agudo  
 aguzzo



?

**46.560.18**  
 Fig. 1

Kleine Biegung  
 small curvature  
 courbure petite  
 curva pequeña  
 curva piccola

?

**46.562.18**  
 Fig. 2

große Biegung  
 large curvature  
 courbure grande  
 curva larga  
 curva grande

Herz-Dilatatore  
Mitral valve Dilators  
Dilatateurs pour valve mitrale  
Dilatadores para válvula mitral  
Dilatatori per valvole mitrali

**dimeda**<sup>®</sup>

SURGICAL INSTRUMENTS

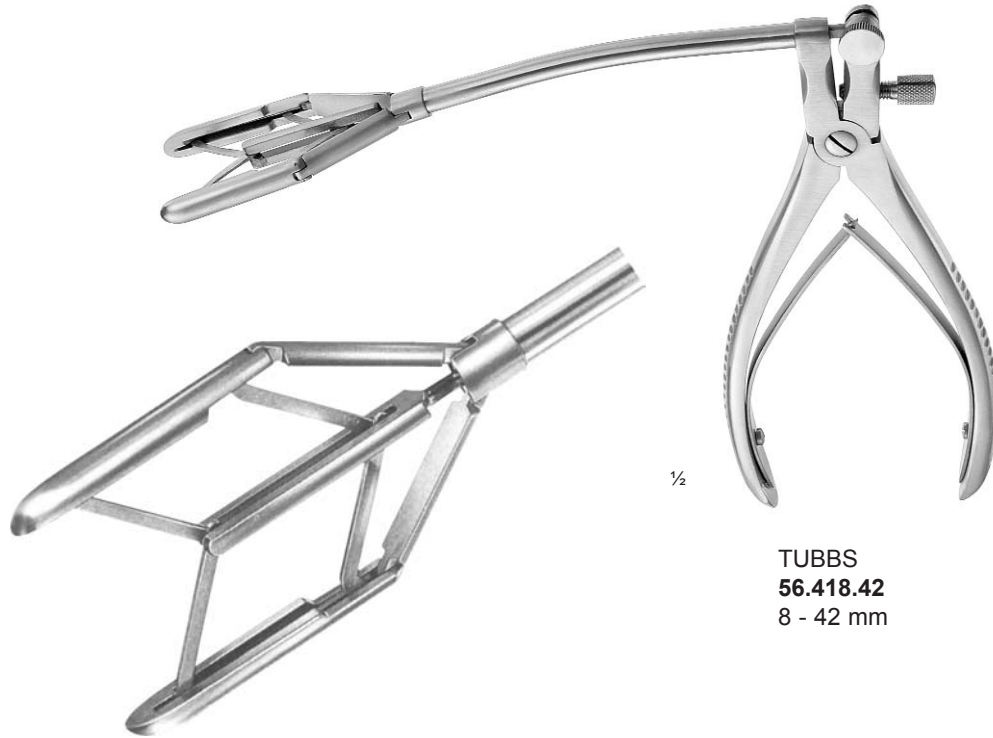

TUBBS  
**56.418.42**  
8 - 42 mm

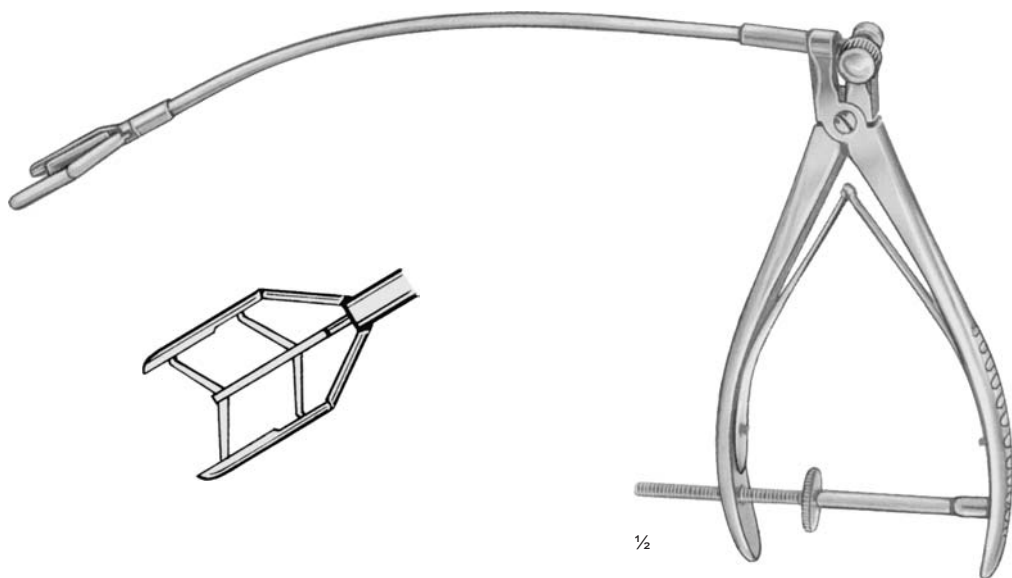

COOLEY  
**56.420.15**  
8 - 15 mm



**56.430.32**  
 ø 3,2 mm

**56.430.64**  
 ø 6,4 mm

flexibel  
 flexible  
 flexibles  
 flexibles  
 flessibili

½

RUMEL-BELMONT  
 33 cm/13"



½

26 cm/10½"



**56.431.15**  
 1,5 mm



**56.431.20**  
 2,0 mm



**56.431.25**  
 2,5 mm











**56.431.30**  
 3,0 mm



1/2

**COOLEY**  
 13 cm/5"

biegsam  
 malleable  
 malléables  
 maleables  
 maleabili













			
<b>56.470.05</b> ø 0,5 mm	<b>56.470.10</b> ø 1,0 mm	<b>56.470.15</b> ø 1,5 mm	<b>56.470.20</b> ø 2,0 mm
			
<b>56.470.25</b> ø 2,5 mm	<b>56.470.30</b> ø 3,0 mm	<b>56.470.40</b> ø 4,0 mm	<b>56.470.50</b> ø 5,0 mm



1/2

**DE BAKEY**  
 19 cm/7 1/2"

biegsam  
 malleable  
 malléables  
 maleables  
 maleabili

					
<b>56.472.05</b> ø 0,5 mm	<b>56.472.10</b> ø 1,0 mm	<b>56.472.15</b> ø 1,5 mm	<b>56.472.20</b> ø 2,0 mm	<b>56.472.25</b> ø 2,5 mm	<b>56.472.30</b> ø 3,0 mm
					
<b>56.472.35</b> ø 3,5 mm	<b>56.472.40</b> ø 4,0 mm	<b>56.472.45</b> ø 4,5 mm	<b>56.472.50</b> ø 5,0 mm	<b>56.472.70</b> ø 7,0 mm	<b>56.472.90</b> ø 9,0 mm

Intima-Spatel, Gefäßdissektoren, Hackchen  
 Intima Spatula, Vascular Dissectors, Hooklets  
 Spatule pour la tunique interne, Dissecteurs vasculaires, Erignes  
 Espátula para la íntima, Disecadores vasculares, Ganchitos  
 Spatola per intima, Dissettori vascolari, Uncini

**dimed**®

SURGICAL INSTRUMENTS



**56.507.14**  
14 cm/5½"

stumpf  
blunt  
mousse  
romo  
smusso



**56.507.24**  
23,5 cm/9"

stumpf  
blunt  
mousse  
romo  
smusso



**56.505.18**  
18,5 cm/7"

**56.505.21**  
21,5 cm/8½"

stumpf  
blunt  
mousse  
romo  
smusso



½

5,0 mm



4,0 mm



3,0 mm



2,0 mm



½

**ROBB**  
24 cm/10"



2,5 mm

**56.509.01**



2,0 mm

**56.509.02**



1,5 mm

**56.509.03**



1,0 mm

**56.509.04**



½

**KILNER**  
**74.103.15**  
14,5 cm/5¾"

?

scharf  
sharp  
pointu  
agudo  
acuto



Inhaltsverzeichnis

Index

Index

Indice alfabético

Indice

**A**

ADSON Baby Präparier- und Ligaturklemmen .....76  
 ADSON-BABY Wundspreizer .....175  
 ADSON micro Pinzetten .....39  
 ADSON Pinzetten .....39  
 ADSON Präparier- und Ligaturklemmen .....76  
 ADSON Saugrohre .....5  
 BECKMANN-ADSON Wundspreizer .....176  
 ALEXANDER Raspatorien .....205  
 ALLIS-Atrauma Darm- und Gewebefaßzangen .....154  
 ALLIS Darm- und Gewebefaßzangen .....154  
 ALLISON Lungenspatel .....178  
 ALLPORT Wundspreizer .....172  
 ALM Wundspreizer .....172  
 Anastomosenklemmen ..118, 121, 123, 133-137, 93-94  
 Anlegepinzette für Clips .....49-51, 53-54, 56  
 Anlege- und Entfernungszange für  
 Bulldogklemmen .....63  
 Aorta-Anastomosenklemmen .....115, 99  
 Aorta-Aneurysma-Klemmen .....102-106,  
 Aortaklemmen .....101, 121-122, 99  
 Aortastanzen .....16  
 Approximatoren .....49-51  
 Arterienklemmen .....65-75, 81-84  
 Atraumatische Bulldogklemmen .....57-62  
 Atraumatische Gefäßklemmen .....87-144  
 Atraumatische Mehrzweckklemmen  
 .....106, 109, 115, 131, 136, 138-139, 96, 98  
 Atraumatische Pinzetten .....43-48  
 Atriumhaken .....179-180  
 Aurikelklemmen .....113

**B**

BABCOCK-Atrauma Darm- und Gewebefaßzangen .155  
 BABCOCK Darm- und Gewebefaßzangen .....155  
 BABY-CRILE-WOOD Nadelhalter .....184  
 Baby MIXTER Arterienklemmen .....82  
 BACKHAUS Tuchklemmen .....145  
 BADGLEY Rippensperrer .....239  
 BAILEY-BABY Rippenkontraktoren .....177  
 BAILEY-GIBBON Rippenkontraktoren .....177  
 BAILEY Rippenkontraktoren .....177  
 BAINBRIDGE Atraumatische Mehrzweckklemmen ..98  
 BALL AND SOCKET Tuchklemmen .....146  
 BENGOLEA Arterienklemmen .....75  
 Bauchspatel .....158  
 BAUMGARTNER Drahtwirbelzangen .....212  
 BECK Atraumatische Mehrzweckklemmen .....115  
 BECKMANN Wundspreizer .....176  
 BERLIN Schlauchklemmen .....86  
 BETHUNE Rippenscheren .....218  
 BEYER Hohlmeißelzangen .....192  
 BIEMER Anlegepinzette für Clips .....49-51, 53  
 BIEMER Approximatoren .....50  
 BIEMER Gefäßclips - für temporären Gebrauch ...53  
 BIEMER - MÜLLER Approximatoren .....49  
 BLAKE Gallensteinzangen .....153  
 BOEHLER Knochensplitterzangen .....197  
 BOROWSKI Aortahaken .....181  
 BRAUN-STADTLER Sternum Scheren .....34  
 BROM Venenwundhaken .....252

Bronchusklemmen .....90  
 BRUNNER Rippenscheren .....220  
 Bulldogklemmen .....57-64  
 Bulldogklemmen mit Ringgriff .....127-128

**C**

Carotis-Shuntklemmen .....123, 138-139  
 CASTAÑEDA Neonatal- und  
 Kinderklemmen, extra feine Modelle ..140, 143-144  
 CASTAÑEDA Rippensperrer .....235  
 CASTROVIEJO Nadelhalter .....189  
 Chirurgische Scheren .....18-20  
 CLEVELAND Knochensplitterzangen .....196  
 Coarctationsklemmen .....117-118, , 131-132, 91-92  
 COOLEY Anastomosenklemmen .....134-135, 137  
 COOLEY Atraumatische Bulldogklemmen .....61  
 COOLEY Atraumatische  
 Mehrzweckklemmen .....131, 136, 138-139  
 COOLEY Atraumatische Pinzetten .....46  
 COOLEY Atriumhaken .....179  
 COOLEY-BECK Anastomosenklemmen .....133-134  
 COOLEY Bulldogklemmen mit Ringgriff .....127-128  
 COOLEY Carotis-Shuntklemmen .....138-139  
 COOLEY Coarctationsklemmen .....131-132  
 COOLEY-DERRA Anastomosenklemmen .....136  
 COOLEY Gefäßdilatoren .....257  
 COOLEY Herz-Dilatoren .....255  
 COOLEY Iliaca-Klemme .....132  
 COOLEY Katheterklemmen .....129  
 COOLEY modif. STRUCK Atriumhaken .....180  
 COOLEY Neonatal- und Kinderklemmen .....133, 136  
 COOLEY Neonatal- und Kinderklemmen,  
 extra feine Modelle .....130, 141-142  
 COOLEY Rippenscheren .....218  
 COOLEY Rippensperrer .....223-225  
 COOLEY Saugrohre .....2  
 CORYLLOS Rippenscheren .....217  
 CORYLLOS Wundhaken .....170  
 CRAFOORD Arterienklemmen .....81  
 CRILE Arterienklemmen .....67  
 CRILE Nervhäkchen .....252  
 CRILE-RANKIN Arterienklemmen .....68  
 CRILE-WOOD Nadelhalter .....184  
 CUSHING Gefäßhäkchen .....252  
 CUSHING-KOCHER Wundhaken .....164  
 CUSHING Pinzetten .....40  
 CUSHING-TAYLOR Pinzetten .....40  
 CUSHING Wundhaken .....162

**D**

DALE Peripheal-Gefäßklemmen .....114  
 DARDIK Atraumatische Mehrzweckklemmen .....96  
 Darm- und Gewebefaßzangen .....154-156  
 DAVIDSON Wundhaken .....171  
 DAVIS Duradisektoren .....253  
 DEEVER Wundhaken .....159-160  
 DE BAKEY-ADSON Atraumatische Pinzetten .....47  
 DE BAKEY Anastomosenklemmen .....118, 123  
 DE BAKEY Aorta-Anastomosenklemmen .....115  
 DE BAKEY Aorta-Aneurysma-Klemmen102, 104, 107-108  
 DE BAKEY Atraumatische Bulldogklemmen .....57, 59

DE BAKEY Atraumatische Gefäßklemmen .....89  
 DE BAKEY Atraumatische Mehrzweckklemmen 106, 109  
 DE BAKEY Atraumatische Pinzetten ..... 44-46, 48  
 DE BAKEY-BAHNSON Aorta-Aneurysma-Klemmen .103  
 DE BAKEY-BECK Atraumatische Mehrzweckklemmen .....115  
 DE BAKEY-CAROTIS Atraumatische Bulldogklemmen .....57  
 DE BAKEY Coarctationsklemmen .....118-119  
 DE BAKEY-DIETRICH Atraumatische Pinzetten .....46  
 DE BAKEY-DIETRICH Atraumatische Bulldogklemmen .....58  
 DE BAKEY Gefäßdilatoren .....257  
 DE BAKEY Gefäß-Scheren .....32-33  
 DE BAKEY-GERALD Atraumatische Pinzetten .....47  
 DE BAKEY-HESS Bulldogklemmen .....64  
 DE BAKEY Iliaca-Klemme .....100  
 DE BAKEY Ligaturklemmen .....123  
 DE BAKEY-MC QUIGGMIXTER Präparier- und Ligaturklemmen .....126  
 DE BAKEY-MIXTER Präparier- und Ligaturklemmen .....125  
 DE BAKEY-MORRIS Aorta-Aneurysma-Klemmen ...105  
 DE BAKEY Nadelhalter .....185-186  
 DE BAKEY Peripheal-Gefäßklemmen .....95, 97  
 DE BAKEY Präparier- und Ligaturklemmen .....116  
 DE BAKEY REYNOLDS Anastomosenklemmen ...121  
 DE BAKEY Rippensperrerr .....231, 241-242  
 DE BAKEY-RUMMEL Präparier- und Ligaturklemmen .....125  
 DE BAKEY-SATINSKY Atraumatische Bulldogklemmen .....57  
 DE BAKEY-SATINSKY Tangentialklemmen .....112  
 DE BAKEY Saugrohre .....4  
 DE BAKEY Titan Atraumatische Pinzetten .....45  
 DE BAKEY-WHEELER Atraumatische Pinzetten .....47  
 DERRA Anastomosenklemmen .....118  
 DESMARRES Wundhaken .....162  
 DIEFFENBACH Bulldogklemmen .....63  
 DIETRICH Gefäß-Scheren .....31  
 DIETRICH Aortaklemmen .....122  
 DIETRICH Bulldogklemmen .....58  
 DOYEN Rippenraspatorien .....206-207  
 Drahtwirbelzangen .....212  
 DUBOST Rippensperrerr .....236  
 DURANTE Pinzetten .....42  
 DUVAL Darm- und Gewebefäßzangen .....156

**E**  
 ECHLIN Hohlmeißelzangen .....196  
 EDWARDS Anlegezange für Clips .....111  
 EDWARDS Clips .....111  
 Einmalskalpelle, steril .....14-15  
 Ersatznadeln .....50

**F**  
 Fadenfänger .....256  
 Fadenklemme .....65  
 FARABEUF Raspatorien .....204  
 FAVALORO Gefäß-Scheren .....33  
 FERGUSON Knochenhalte-zangen .....202

FINOCHIETTO BABY-HAIGHT Rippensperrerr .....228  
 FINOCHIETTO-BABY Rippensperrerr .....223  
 FINOCHIETTO BURFORD Rippensperrerr .230, 232-234  
 FINOCHIETTO INFANT Rippensperrerr .....229  
 FINOCHIETTO (modif.) Rippensperrerr .....222  
 FINOCHIETTO Nadelhalter .....188  
 FINOCHIETTO Präparier- und Ligaturklemmen ...150  
 FINOCHIETTO Rippensperrerr .....222, 227-229  
 FINSTERER Saugrohre .....4  
 FISCH Durahäckchen .....253  
 Flachzangen .....210-211  
 FOERSTER Tupferzangen .....148  
 FRAZIER Saugrohre .....6  
 FREER Septumelevatorium .....254  
 FRYKHOLM Hohlmeißelzangen .....195  
 FUCHSIG Präparier- und Ligaturklemmen .....76

**G**

Gefäßclips - für temporären Gebrauch .....52-55  
 Gefäß-Scheren .....29-33  
 GEMINI mini Präparier- und Ligaturklemmen .....77  
 GEMINI Präparier- und Ligaturklemmen .....77  
 GERALD Pinzetten .....41  
 Gewebw und Organ-Faßzange .....114  
 GIERTZ-STILLE Rippenscheren .....219  
 GILLIES Häckchen .....254  
 GILLIES Pinzetten .....41  
 GLASSMAN Atraumatische Pinzetten .....47  
 GLOVER Anastomosenklemmen .....93-94  
 GLOVER Atraumatische Bulldogklemmen .....57, 60  
 GLOVER Coarctationsklemmen .....120, 91  
 GLUCK Rippenscheren .....216  
 GOSLEE Flachzangen .....211  
 GREGORY Atraumatische Bulldogklemmen .....57  
 GREGORY Profunda-Klemmen .....126  
 GROSS-MAIER Tupferzangen .....147

**H**

HABERER Bauchspatel .....158  
 HAIGHT Rippensperrerr .....238  
 HALLE Septumelevatorium .....252  
 HALSEY Nadelhalter .....184  
 HALSTEAD-MOSQUITO Arterienklemmen .....66  
 HALSTEAD-MOSQUITO Atraumatische Gefäßklemmen .....87  
 HALSTEAD-MOSQUITO micro Arterienklemmen ...66  
 HARKEN Aurikelklemmen .....113  
 HARRINGTON Wundhaken .....161  
 HARTMANN Arterienklemmen .....65  
 HARVEY Seitenschneider, Drahtkneifzangen .....214  
 HEANEY Nadelhalter .....187  
 HEGAR-VASCULAR Nadelhalter .....187  
 HEISS Arterienklemmen .....75  
 HENLEY Wundspreizer .....173  
 HERTZLER Rippensperrerr .....246  
 Herz-Dilatatorien .....255  
 Hohlmeißelzangen .....192-196  
 HOPT Atraumatische Gefäßklemmen .....88

**I**  
 Iliaca-Klemme .....100, 132  
 Intimaspatel .....258  
 IRIS Scheren .....28

**J**  
 JAVID Carotis-Shuntklemmen .....123  
 JOHN-HOPKINS Bulldogklemmen .....63  
 JONES-CLIP Tuchklemmen .....145  
 JONES Tuchklemmen .....145  
 JOSEPH Plastik Scheren .....26

**K**  
 KADER Bauchspatel .....158  
 KELLY Arterienklemmen .....67  
 KELLY-RANKIN Arterienklemmen .....67  
 KELLY Wundhaken .....168  
 KILNER Häckchen .....258  
 KILNER Plastik Scheren .....27  
 Knochendraht .....210  
 Knochenhalte­zangen .....202-203  
 Knochensplitterzangen .....196-201  
 KOCHER Arterienklemmen Grazilles Modell .....71  
 KOCHER-LANGENBECK Wundhaken .....165  
 KOCHER-NIPPON Arterienklemmen .....72  
 KOCHER Wundhaken .....164  
 KOENIG Wundhaken .....164  
 KRAYENBÜHL Nervhäkchen .....252

**L**  
 LAMBERT KAY Aorta-Anastomosenklemmen .....99  
 LAMBOTTE Raspatorien .....204  
 LANGENBECK Knochenhalte­zangen .....202  
 LANGENBECK Raspatorien .....205  
 LANGENBECK Wundhaken .....163-164  
 LAWRENCE Arterienklemmen .....82  
 LEBSCHKE Sternummeißel .....204  
 LEES Bronchusklemmen .....90  
 LEKSELL-STILLE Hohlmeißelzangen .....195  
 LELAND-JONES Atraumatische  
 Mehrzweckklemmen .....98  
 LELAND-JONES Peripheal-Gefäßklemmen .....97  
 LERICHE Arterienklemmen .....74  
 LEXER-FINO Präparierscheren .....22  
 LEXER Präparierscheren .....23  
 LICHTENBERG Nadelhalter .....189  
 LIDDLE Aortaklemmen .....99  
 Ligaturklemmen .....123  
 LISTER Tupferzangen .....149  
 LISTON Knochensplitterzangen .....197  
 LOVELACE Arterienklemmen .....74  
 LOVELACE Lungenfaßzangen .....151  
 Lungenspatel .....178

**M**  
 MAMMARIA Rippensperrer .....226  
 MARQUARDT Hohlmeißelzangen .....192  
 MARTIN Bauchspatel .....158  
 MARTIN Peripheal-Gefäßklemmen .....124  
 MARTIN Tupferzangen .....149

MARTIN Wundhaken .....169  
 MATHIEU Nadelhalter .....188  
 MAYO-HEGAR Nadelhalter .....185  
 MAYO Präparierscheren .....21  
 MAYO-STILLE Präparierscheren .....22  
 MCINDOE Knochensplitterzangen .....198  
 McINDOE Pinzetten .....42  
 McQUIGG-MIXTER Arterienklemmen .....84  
 MEHDORN Anlegepinzette für Clips .....54  
 MEHDORN Gefäßclips für temporären Gebrauch .....54  
 MERCEDES Rippensperrer .....243  
 METZENBAUM FINO Präparierscheren .....25  
 METZENBAUM FINO "S" Präparierscheren .....26  
 METZENBAUM-NELSON Präparierscheren .....26  
 METZENBAUM Präparierscheren .....24  
 Mikrochirurgie-Pinzetten .....43  
 Mikro-gefäß Scheren .....35  
 Mikro-Skalpellklingen .....13  
 MIKULICZ-Baby Peritoneumklemmen .....85  
 MIKULICZ Peritoneumklemmen .....85  
 MIKULICZ Wundhaken .....167  
 MINI Anlegepinzette für Clips .....56  
 MINI Gefäßclips - für temporären Gebrauch .....55  
 MIXTER Arterienklemmen .....83-84  
 MIXTER Baby Arterienklemmen .....83  
 MIXTER-O'SHAUGNESSY Arterienklemmen .....84  
 MORSE STERNAL FAVOROLO Rippensperrer .....245  
 MORSE STERNAL Rippensperrer .....244-245  
 MÜLLER Approximatoren .....51  
 MÜLLER Gefäßclips - für temporären Gebrauch .....52  
 MURPHY Schlauchklemmen .....86

**N**  
 NABATOFF Venenstripper .....248  
 Nadelhalter .....184-189  
 NELSON Pinzetten .....42  
 Neonatal- und Kinderklemmen ..130, 133, 136, 140-144  
 Nerv-Präparierschere .....34

**O**  
 OCHSNER Aortaklemmen .....122  
 OVERHOLT-BABY Präparier- und Ligaturklemmen .....78  
 OVERHOLT fino Präparier- und Ligaturklemmen .....79  
 OVERHOLT-GEISSENDOERFER Präparier- und  
 Ligaturklemmen .....78  
 OVERHOLT-MIXTER Präparier- und Ligaturklemmen 80  
 OVERHOLT Präparier- und Ligaturklemmen .....79-80

**P**  
 PEAN Arterienklemmen Grazilles Modell .....71  
 PEAN Atraumatische Gefäßklemmen .....87  
 PEAN-NIPPON Arterienklemmen .....72  
 PEERS BERTRAM Tuchklemmen .....145  
 Peripheal-Gefäßklemmen .....114, 124, 95, 97  
 Peritoneumklemmen .....85  
 Pinzetten .....38-42  
 POPPEN Saugrohre .....5  
 POTTS Coarctationsklemmen .....117, 91-92  
 POTTS-SMITH Gefäß-Scheren .....29-31  
 POTTS-SMITH Pinzetten .....38

Präparierscheren .....21-25  
 Präparier- und Ligaturklemmen 116, 125-126, 150, 76-80  
 PRESBYTERIAN HOSPITAL Schlauchklemmen .....86  
 PRICE-THOMAS Bronchusklemmen .....152  
 Profunda-Klemmen .....126  
 PROVIDENCE-HOSPITAL Arterienklemmen .....68

**R**

RANKIN Atraumatische Gefäßklemmen .....88  
 Raspatorien .....204-209  
 REILL Seitenschneider, Drahtkneifzangen .....214  
 REYNOLDS Scheren .....27  
 RIBBON Bauchspatel .....158  
 Rippenkontraktoren .....177  
 Rippenscheren .....215-220  
 Rippensperrerr .....222-246  
 ROBB Gefäßdissektoren .....258  
 ROCHESTER-CARMALT Arterienklemmen .....73  
 ROCHESTER-OCHSNER Arterienklemmen .....70  
 ROCHESTER-PEAN Arterienklemmen .....69  
 RUMEL-BELMONT Tourniquets .....256  
 RUMMEL Arterienklemmen .....81  
 RUSKIN Hohlmeißelzangen .....192  
 RUSKIN LISTON Knochensplitterzangen .....198  
 Russ. Mod. Pinzetten .....42  
 RYDER Nadelhalter .....186

**S**

SANTULLI Atraumatische Bulldogklemmen .....57  
 SANVENERO Scheren .....26  
 SAROT Arterienklemmen .....81  
 SAROT Nadelhalter .....188  
 SATINSKY Anastomosen- (Vena cava) Klemmen .....153  
 SATINSKY Scheren .....34  
 SATINSKY Tangentialklemmen .....110  
 SAUERBRUCH Hohlmeißelzangen .....194  
 SAUERBRUCH Wundhaken .....171  
 SAUERBUCH-FREY Rippenscheren .....220  
 SAUERBUCH Rippenscheren .....219  
 Saugrohre .....2-6  
 Saugspitze .....3  
 SCHAEDEL Tuchklemmen .....145  
 SCHEIBE Darm- und Gewebefäßzangen .....156  
 Scheren .....26-28, 34  
 Schlauchklemmen .....86  
 Schlaucholive .....3  
 Schlüssel .....50  
 SCHMID Gefäßspülkanülen .....5  
 SCHNIDT Präparier- und Ligaturklemmen .....150  
 SCHUMACHER Sternum Schere .....215  
 Seitenschneider, Drahtkneifzangen .....213  
 SELLORS Rippenkontraktoren .....177  
 SEMB Bronchusklemmen .....153  
 SEMB Hohlmeißelzangen .....196  
 SEMB Knochenhalte zangen .....203  
 SEMB Knochensplitterzangen .....201  
 SEMB Raspatorien .....208  
 SEMKEN Pinzetten .....41  
 SIMON Wundhaken .....169  
 SINGLY Pinzetten .....42  
 Skalpellgriffe .....13, 8-10

Skalpellklingen-Entferner .....12  
 Skalpellklingen, steril .....11-13  
 SPENCER-WELLS Arterienklemmen .....73  
 STANDARD Anlegepinzette für Clips .....56  
 STANDARD Gefäßclips für temporären Gebrauch .....55  
 STILLE HORSLEY Knochensplitterzangen .....201  
 STILLE LISTON Knochensplitterzangen .....199-200  
 STILLE LUER Hohlmeißelzangen .....193-194  
 STILLE Rippenscheren .....216  
 STRUCK Rippensperrerr .....237  
 SUBRAMANIAN Aortaklemmen .....121  
 SUBRAMANIAN-MINIATURE Aortaklemmen .....121

**T**

Tangentialklemmen .....110, 112  
 Titan Arterienklemmen .....66-67  
 Titan Atraumatische Bulldogklemmen .....62  
 Titan Atraumatische Pinzetten .....44  
 Titan Mikrochirurgie-Pinzetten .....43  
 TOENNIS-ADSON Scheren .....34  
 TOENNIS Duradisektoren .....253  
 TOHOKU Tuchklemmen .....146  
 TUBBS Herz-Dilatatoren .....255  
 Tuchklemmen .....145-146  
 TUFFIER Rippensperrerr .....240  
 Tupferzangen .....147-149

**U**

ULRICH Tupferzangen .....147

**V**

VARADY Varizeninstrumente .....251  
 VARADY Venenstripper .....249  
 Venenstripper .....248-249  
 VOLKMANN Wundhaken .....163  
 VOLLMAR Ringstripper .....250

**W**

WALTON YANKAUER Saugrohre .....3  
 WANGENSTEEN Nadelhalter .....187  
 WANGENSTEEN Pinzetten .....42  
 WAUGH Pinzetten .....40  
 WEBER Aortaklemmen .....101  
 WECKER Irisspatel .....254  
 WEINBERG Rippensperrerr .....235  
 WEITLANER Wundspreizer .....172-175  
 WICKSTROEM Arterienklemmen .....84  
 Wundhaken .....159-171  
 Wundspreizer .....172-176  
 WYLIE Atraumatische Gefäßklemmen .....112

**Y**

YANKAUER Saugrohre .....3

**Z**

ZAUFAL JANSEN Hohlmeißelzangen .....192  
 ZENKER Arterienklemmen .....82  
 ZENKER Wundhaken .....166



**A**

Abdominal Spatulas .....158  
 ADSON Baby dissecting and ligature forceps .....76  
 ADSON-BABY wound spreaders, self-retaining .....175  
 ADSON dissecting and ligature forceps .....76  
 ADSON micro Thumb and Tissue Forceps .....39  
 ADSON Suction Tubes .....5  
 ADSON Thumb and Tissue Forceps .....39  
 BECKMANN-ADSON wound spreaders .....176  
 ALEXANDER periosteal elevators .....205  
 ALLIS-Atrauma bowel and tissue grasping forceps .....154  
 ALLIS bowel and tissue grasping forceps .....154  
 ALLISON lung spatulas .....178  
 ALLPORT wound spreaders, self-retaining .....172  
 ALM wound spreaders, self-retaining .....172  
 Anastomosis clamps .....118, 121, 123, 133-137, 93-94  
 Aorta-anastomosis clamps .....115, 99  
 Aorta-aneurysm clamps .....102-106,  
 Aortic clamp .....101, 121-122, 99  
 Aortic Punches .....16  
 Applying and removing forceps  
 for Bulldog clamps .....63  
 Applying forceps for Clips .....49-51, 53-54, 56  
 Approximators .....49-51  
 Atraumatic bulldog clamps .....57-62  
 Atraumatic multi-purpose  
 clamps .....106, 109, 115, 131, 136, 138-139, 96, 98  
 Atraumatic Tissue Forceps .....43-48  
 Atraumatic vascular clamps .....87-144  
 Atrium Retractors .....179-180  
 Auricle clamps .....113

**B**

BABCOCK-Atrauma tissue grasping forceps .....155  
 BABCOCK bowel and tissue grasping forceps .....155  
 BABY-CRILE-WOOD needle holders .....184  
 Baby MIXTER hemostatic forceps .....82  
 BACKHAUS towel clamps .....145  
 BADGLEY rib spreaders .....239  
 BAILEY-BABY rib contractors .....177  
 BAILEY-GIBBON rib contractors .....177  
 BAILEY rib contractors .....177  
 BAINBRIDGE atraumatic multi-purpose clamps .....98  
 BALL AND SOCKET towel clamps .....146  
 BENGOLEA hemostatic forceps .....75  
 BAUMGARTNER wire twisting forceps .....212  
 BECK atraumatic multi-purpose clamps .....115  
 BECKMANN wound spreaders, self-retaining .....176  
 BERLIN tubing clamps .....86  
 BETHUNE rib shears .....218  
 BEYER bone rongeurs .....192  
 BIEMER Applying forceps for clips .....49-51, 53  
 BIEMER Approximators .....50  
 BIEMER - MÜLLER Approximators .....49  
 BIEMER vessels clips - for temporary occlusion .....53  
 BLAKE gall stone forceps .....153  
 BOEHLER bone cutting forceps .....197  
 Bone Cutting forceps .....196-201  
 Bone Holding Forceps .....202-203  
 Bone Rongeurs .....192-196  
 Bone Wire .....210

BOROWSKI Aorta Retractors .....181  
 Bowel and tissue grasping forceps .....154-156  
 BRAUN-STADTLER Sternum scissors .....34  
 BROM venous retractor .....252  
 Bronchus forceps .....90  
 BRUNNER rib shears .....220  
 Bulldog clamps .....57-64

**C**

Carotid shunt clamps .....123, 138-139  
 CASTAÑEDA neonatal and childrens clamps,  
 extra delicate patterns .....140, 143-144  
 CASTAÑEDA rib spreaders .....235  
 CASTROVIEJO needle holders .....189  
 CLEVELAND bone cutting forceps .....196  
 Coarction clamps .....117-118, 131-132, 91-92  
 COOLEY anastomosis clamps .....134-135, 137  
 COOLEY atraumatic bulldog clamps .....61  
 COOLEY atraumatic multi-purpose  
 clamps .....131, 136, 138-139  
 COOLEY Atraumatic Tissue Forceps .....46  
 COOLEY atrium retractors .....179  
 COOLEY-BECK anastomosis clamps .....133-134  
 COOLEY carotid shunt clamps .....138-139  
 COOLEY catheter clamps .....129  
 COOLEY coarction clamps .....131-132  
 COOLEY-DERRA anastomosis clamps .....136  
 COOLEY iliac clamp .....132  
 COOLEY mitral valve dilators .....255  
 COOLEY modif. STRUCK atrium retractors .....180  
 COOLEY neonatal and childrens clamps .....133, 136  
 COOLEY neonatal and childrens clamps,  
 extra delicate patterns .....130, 141-142  
 COOLEY rib shears .....218  
 COOLEY rib spreaders .....223-225  
 COOLEY ring bulldog clamps .....127-128  
 COOLEY Suction Tubes .....2  
 COOLEY vascular dilators .....257  
 CORYLLOS retractors .....170  
 CORYLLOS rib shears .....217  
 CRAFOORD hemostatic forceps .....81  
 CRILE hemostatic forceps .....67  
 CRILE Nerve hooks .....252  
 CRILE-RANKIN hemostatic forceps .....68  
 CRILE-WOOD needle holders .....184  
 CUSHING-KOCHER retractors .....164  
 CUSHING retractors .....162  
 CUSHING-TAYLOR Thumb and Tissue Forceps .....40  
 CUSHING Thumb and Tissue Forceps .....40  
 CUSHING vessel hooks .....252

**D**

DALE peripheal vascular clamps .....114  
 DARDIK atraumatic multi-purpose clamps .....96  
 DAVIDSON retractors .....171  
 DAVIS dura dissectors .....253  
 DEAVER retractors .....159-160  
 DE BAKEY-ADSON Atraumatic Tissue Forceps .....47  
 DE BAKEY anastomosis clamps .....118, 123  
 DE BAKEY aorta-anastomosis clamps .....115  
 DE BAKEY aorta-aneurysm clamps .....102, 104, 107-108

DE BAKEY atraumatic bulldog clamps	57, 59
DE BAKEY atraumatic multi-purpose clamps	106, 109
DE BAKEY Atraumatic Tissue Forceps	44-46, 48
DE BAKEY Atraumatic vascular clamps	89
DE BAKEY-BAHNSON aorta-aneurysm clamps	103
DE BAKEY-BECK atraumatic multi-purpose clamps	115
DE BAKEY-CAROTIS atraumatic bulldog clamps	57
DE BAKEY coarction clamps	118-119
DE BAKEY-DIETHRICH Atraumatic tissue forceps	46
DE BAKEY-DIETRICH atraumatic bulldog clamps	58
DE BAKEY Dissecting and ligature clamps	116
DE BAKEY-GERALD Atraumatic Tissue Forceps	47
DE BAKEY-HESS bulldog clamps	64
DE BAKEY iliac clamp	100
DE BAKEY ligature clamps	123
DE BAKEY-MC QUIGGMIXTER Dissecting and ligature clamps	126
DE BAKEY-MIXTER Dissecting and ligature clamps	125
DE BAKEY-MORRIS aorta-aneurysm clamps	105
DE BAKEY needle holders	185-186
DE BAKEY peripheal vascular clamps	95, 97
DE BAKEY REYNOLDS anastomosis clamps	121
DE BAKEY rib spreaders	231, 241-242
DE BAKEY-RUMMEL Dissecting & ligature clamps	125
DE BAKEY-SATINSKY atraumatic bulldog clamps	57
DE BAKEY-SATINSKY tangential occlusion clamps	112
DE BAKEY Suction Tubes	4
DE BAKEY Titanium atraumatic tissue forceps	45
DE BAKEY vascular dilators	257
DE BAKEY Vascular Scissors	32-33
DE BAKEY-WHEELER atraumatic tissue forceps	47
DERRA anastomosis clamps	118
DESMARRES retractors	162
DIEFFENBACH bulldog clamps	63
DIETHRICH Vascular Scissors	31
DIETRICH aortic clamp	122
DIETRICH bulldog clamps	58
Disposable Scalpels, sterile	14-15
Dissecting and ligature clamps	116
Dissecting and Ligature Clamps	125-126, 150
Dissecting and ligature forceps	76-80
Dissecting Scissors	21-25
DOYEN rib raspatories	206-207
Dressing & sponge forceps	147-149
DUBOST rib spreaders	236
DURANTE Thumb and Tissue Forceps	42
DUVAL bowel and tissue grasping forceps	156
<b>E</b>	
ECHLIN bone rongeurs	196
EDWARDS applying forceps for clips	111
EDWARDS clips	111
<b>F</b>	
FARABEUF periosteal elevators	204
FAVALORO Vascular Scissors	33
FERGUSON bone holding forceps	202
FINOCHIETTO BABY-HAIGHT rib spreaders	228
FINOCHIETTO-BABY rib spreaders	223
FINOCHIETTO BURFORD rib spreaders	230, 232-234

FINOCHIETTO dissecting and ligature clamps	150
FINOCHIETTO INFANT rib spreaders	229
FINOCHIETTO (modif.) rib spreaders	222
FINOCHIETTO needle holders	188
FINOCHIETTO rib spreaders	222, 227-229
FINSTERER Suction Tubes	4
FISCH dura retractor	253
Flat Nose Pliers	210-211
FOERSTER dressing & sponge forceps	148
FRAZIER Suction Tubes	6
FREER septum elevators	254
FRYKHOLM bone rongeurs	195
FUCHSIG dissecting and ligature forceps	76

**G**

GEMINI dissecting and ligature forceps	77
GEMINI mini dissecting and ligature forceps	77
GERALD Thumb and Tissue Forceps	41
GIERTZ-STILLE rib shears	219
GILLIES hooklets	254
GILLIES Thumb and Tissue Forceps	41
GLASSMAN Atraumatic Tissue Forceps	47
GLOVER anastomosis clamps	93-94
GLOVER atraumatic bulldog clamps	57, 60
GLOVER coarction clamps	120, 91
GLUCK rib shears	216
GOSLEE flat nose pliers	211
GREGORY atraumatic bulldog clamps	57
GREGORY profunda clamps	126
GROSS-MAIER dressing & sponge forceps	147

**H**

HABERER abdominal spatulas	158
HAIGHT rib spreaders	238
HALLE septum elevators	252
HALSEY needle holders	184
HALSTEAD-MOSQUITO Atraumatic vascular clamps	87
HALSTEAD-MOSQUITO hemostatic forceps	66
HALSTEAD-MOSQUITO micro hemostatic forceps	66
HARKEN auricle clamps	113
HARRINGTON retractors	161
HARTMANN hemostatic forceps	65
HARVEY wire cutting pliers	214
HEANEY needle holders	187
HEGAR-VASCULAR needle holders	187
HEISS hemostatic forceps	75
Hemostatic forceps	65-75, 81-84
HENLEY wound spreaders, self-retaining	173
HERTZLER rib spreaders	246
HOPT Atraumatic vascular clamps	88

**I**

Iliac clamp	100, 132
Intima Spatula	258
IRIS Scissors	28

**J**

JAVID carotid shunt clamps	123
JOHN-HOPKINS bulldog clamps	63

JONES-CLIP towel clamps	145
JONES towel clamps	145
JOSEPH Plastic Scissors	26

**K**

KADER abdominal spatulas	158
KELLY hemostatic forceps	67
KELLY-RANKIN hemostatic forceps	67
KELLY retractors	168
Key	50
KILNER hooklets	258
KILNER Plastic Scissors	27
KOCHER hemostatic forceps delicate pattern	71
KOCHER-LANGENBECK retractors	165
KOCHER-NIPPON hemostatic forceps	72
KOCHER retractors	164
KOENIG retractors	164
KRAYENBÜHL Nerve hooks	252

**L**

LAMBERT KAY aorta-anastomosis clamps	99
LAMBOTTE periosteal elevators	204
LANGENBECK bone holding forceps	202
LANGENBECK periosteal elevators	205
LANGENBECK retractors	163-164
LAWRENCE hemostatic forceps	82
LEBSCHKE sternum chisel	204
LEES bronchus forceps	90
LEKSELL-STILLE bone rongeurs	195
LELAND-JONES atraumatic multi-purpose clamps	98
LELAND-JONES peripheal vascular clamps	97
LERICHE hemostatic forceps	74
LEXER Dissecting Scissors	23
LEXER-FINO Dissecting Scissors	22
LICHTENBERG needle holders	189
LIDDLE aortic clamp	99
Ligature catchers	256
Ligature clamps	123
Ligature forceps	65
LISTER dressing & sponge forceps	149
LISTON bone cutting forceps	197
LOVELACE hemostatic forceps	74
LOVELACE lung grasping forceps	151
Lung Spatulas	178

**M**

MAMMARIA rib spreaders	226
MARQUARDT bone rongeurs	192
MARTIN abdominal spatulas	158
MARTIN dressing & sponge forceps	149
MARTIN peripheal vascular clamps	124
MARTIN retractors	169
MATHIEU needle holders	188
MAYO Dissecting Scissors	21
MAYO-HEGAR needle holders	185
MAYO-STILLE Dissecting Scissors	22
MCINDOE bone cutting forceps	198
McINDOE Thumb and Tissue Forceps	42
McQUIGG-MIXTER hemostatic forceps	84
MEHDORN Applying forceps for clips	54

MEHDORN vessels clips for temporary occlusion	54
MERCEDES rib spreaders	243
METZENBAUM Dissecting Scissors	24
METZENBAUM FINO Dissecting Scissors	25
METZENBAUM FINO "S" Dissecting Scissors	26
METZENBAUM-NELSON Dissecting Scissors	26
Micro Scalpel Blades	13
Microsurgery Forceps	43
MIKULICZ-Baby peritoneal clamp forceps	85
MIKULICZ peritoneal clamp forceps	85
MIKULICZ retractors	167
MINI applying forceps for Clips	56
MINI vessels clips - for temporary occlusion	55
Mitral Valve Dilators	255
MIXTER Baby hemostatic forceps	83
MIXTER hemostatic forceps	83-84
MIXTER-O'SHAUGNESSY hemostatic forceps	84
MORSE STERNAL FAVOROLO rib spreaders	245
MORSE STERNAL rib spreaders	244-245
MÜLLER Approximators	51
MÜLLER vessels clips - for temporary occlusion	52
MURPHY tubing clamps	86

**N**

NABATOFF vein strippers	248
Needle Holders	184-189
NELSON Thumb and Tissue Forceps	42
Neonatal and Childrens Clamps	130
Neonatal and childrens clamps	133
Neonatal and Childrens Clamps	136
Neonatal and childrens clamps	140-144
Never dissecting scissors	34

**O**

OCHSNER aortic clamp	122
Olive	3
Operating Scissors	18-20
OVERHOLT-BABY dissecting and ligature forceps	78
OVERHOLT dissecting and ligature forceps	79-80
OVERHOLT fino dissecting and ligature forceps	79
OVERHOLT-GEISSENDOERFER dissecting and ligature forceps	78
OVERHOLT-MIXTER dissecting and ligature forceps	80

**P**

PEAN Atraumatic vascular clamps	87
PEAN hemostatic forceps delicate pattern	71
PEAN-NIPPON hemostatic forceps	72
PEERS BERTRAM towel clamps	145
Periosteal Elevators	204-209
Peripheal vascular clamps	114, 124, 95, 97
Peritoneal clamp forceps	85
POPPE suction tubes	5
POTTS coarction clamps	117, 91-92
POTTS-SMITH thumb and tissue forceps	38
POTTS-SMITH vascular scissors	29-31
PRESBYTERIAN HOSPITAL tubing clamps	86
PRICE-THOMAS bronchus forceps	152



Profunda Clamps	126
PROVIDENCE-HOSPITAL hemostatic forceps	68

**R**

RANKIN Atraumatic vascular clamps	88
REILL wire cutting pliers	214
Retractors	159-171
REYNOLDS Scissors	27
RIBBON abdominal spatulas	158
Rib Contractors	177
Rib Shears	215-220
Rib Spreaders	222-246
Ring bulldog clamps	127-128
ROBB vascular dissectors	258
ROCHESTER-CARMALT hemostatic forceps	73
ROCHESTER-OCHSNER hemostatic forceps	70
ROCHESTER-PEAN hemostatic forceps	69
RUMEL-BELMONT tourniquets	256
RUMMEL hemostatic forceps	81
RUSKIN bone rongeurs	192
RUSKIN LISTON bone cutting forceps	198
Russ. Mod. Thumb and Tissue Forceps	42
RYDER needle holders	186

**S**

SANTULLI atraumatic bulldog clamps	57
SANVENERO Scissors	26
SAROT hemostatic forceps	81
SAROT needle holders	188
SATINSKY anastomosis (vena cava) clamps	153
SATINSKY Scissors	34
SATINSKY tangential occlusion clamps	110
SAUERBRUCH bone rongeurs	194
SAUERBRUCH retractors	171
SAUERBUCH-FREY rib shears	220
SAUERBUCH rib shears	219
Scalpel Blade Remover	12
Scalpel Blades, sterile	11-13
Scalpel Handles	13, 8-10
SCHAEDEL towel clamps	145
SCHEIBE bowel and tissue grasping forceps	156
SCHMID Vascular irrigation cannulae	5
SCHNIDT dissecting and ligature clamps	150
SCHUMACHER sternum scissors	215
Scissors	26-28, 34
SELLORS rib contractors	177
SEMB bone cutting forceps	201
SEMB bone holding forceps	203
SEMB bone rongeurs	196
SEMB bronchus forceps	153
SEMB periosteal elevators	208
SEMKEN Thumb and Tissue Forceps	41
SIMON retractors	169
SINGLY Thumb and Tissue Forceps	42
Spare needles	50
SPENCER-WELLS hemostatic forceps	73
STANDARD applying forceps for Clips	56
STANDARD vessels clips for temporary occlusion	55
STILLE HORSLEY bone cutting forceps	201
STILLE LISTON bone cutting forceps	199-200
STILLE LUER bone rongeurs	193-194

STILLE rib shears	216
STRUCK rib spreaders	237
SUBRAMANIAN aortic clamp	121
SUBRAMANIAN-MINIATURE aortic clamp	121
Suction Tip	3
Suction Tubes	2-6

**T**

Tangential occlusion clamps	110, 112
Thumb and Tissue Forceps	38-42
Tissue and organ holding forceps	114
Titanium atraumatic bulldog clamps	62
Titanium Atraumatic Tissue Forceps	44
Titanium hemostatic forceps	66-67
Titanium Microsurgery Forceps	43
TOENNIS-ADSON Scissors	34
TOENNIS dura dissectors	253
TOHOKU towel clamps	146
Towel clamps	145-146
TUBBS mitral valve dilators	255
Tubing clamps	86
TUFFIER rib spreaders	240

**U**

ULRICH dressing & sponge forceps	147
----------------------------------	-----

**V**

VARADY varix instruments	251
VARADY vein strippers	249
Vascular Micro Scissors	35
Vascular Scissors	29-33
Vein Strippers	248-249
Vessels Clips - for temporary occlusion	52-55
VOLKMANN retractors	163
VOLLMAR ring strippers	250

**W**

WALTON YANKAUER Suction Tubes	3
WANGENSTEEN needle holders	187
WANGENSTEEN Thumb and Tissue Forceps	42
WAUGH Thumb and Tissue Forceps	40
WEBER aortic clamp	101
WECKER iris spatula	254
WEINBERG rib spreaders	235
WEITLANER wound spreaders, self-retaining	172-175
WICKSTROEM hemostatic forceps	84
Wire Cutting Pliers	213
Wire Twisting Forceps	212
Wound Spreaders, self-retaining	172-176
WYLIE Atraumatic vascular clamps	112

**Y**

YANKAUER Suction Tubes	3
------------------------	---

**Z**

ZAUFAL JANSEN bone rongeurs	192
ZENKER hemostatic forceps	82
ZENKER retractors	166

**A**

ADSON-BABY écarteurs autostatiques .....175  
 ADSON Baby pinces à dissection et à ligatures .....76  
 BECKMANN-ADSON écarteurs autostatiques .....176  
 ADSON micro Pinces à dissection .....39  
 ADSON Pinces à dissection .....39  
 ADSON pinces à dissection et à ligatures .....76  
 ADSON Tubes d'aspiration .....5  
 Aiguilles de rechange .....50  
 ALEXANDER rugines-raspatoires .....205  
 ALLIS-Atrauma pinces à saisir les intestins et  
 les tissus .....154  
 ALLISON spatules pulmonaires .....178  
 ALLIS pinces à saisir les intestins et les tissus .....154  
 ALLPORT écarteurs autostatiques .....172  
 ALM écarteurs autostatiques .....172  
 Approximateurs .....49-51

**B**

BABCOCK-Atrauma pinces à saisir les intestins et  
 les tissus .....155  
 BABCOCK pinces à saisir les intestins et les tissus .....155  
 BABY-CRILE-WOOD porte-aiguilles .....184  
 Baby MIXTER pinces hémostatiques .....82  
 BACKHAUS pinces à champs .....145  
 BADGLEY écarteurs des côtes .....239  
 BAILEY-BABY rapprocheurs de côtes .....177  
 BAILEY-GIBBON rapprocheurs de côtes .....177  
 BAILEY rapprocheurs de côtes .....177  
 BAINBRIDGE pinces-clamps polyvalentes .....98  
 BALL AND SOCKET pinces à champs .....146  
 BENGOLEA pinces hémostatiques .....75  
 BAUMGARTNER pinces à torsader le fil .....212  
 BECKMANN écarteurs autostatiques .....176  
 BECK pinces-clamps polyvalentes .....115  
 BERLIN pinces serre-tubes .....86  
 BETHUNE costotomes .....218  
 BEYER pinces-gouges .....192  
 BIEMER Approximateurs .....50  
 BIEMER - MÜLLER Approximateurs .....49  
 BIEMER Pince pour serre-fines .....49-51, 53  
 BIEMER serre-fines - pour occlusion temporaire .....53  
 Bistouris usage unique, stériles .....14-15  
 BLAKE pinces pour calculs biliaires .....153  
 BOEHLER pinces coupantes à os .....197  
 BOROWSKI Écarteurs pour aorta .....181  
 BRAUN-STADTLER Ciseaux a sternum .....34  
 BROM écarteur pour veines .....252  
 BRUNNER costotomes .....220

**C**

CASTAÑEDA écarteurs des côtes .....235  
 CASTAÑEDA Pinces-clamps pour des nouveaux-nés  
 et des enfants, modèles très fins .....140, 143-144  
 CASTROVIEJO porte-aiguilles .....189  
 Ciseaux .....26-28, 34  
 Ciseaux à chirurgie .....18-20  
 Ciseaux à dissection .....21-25  
 Ciseaux a preparation de nerfs .....34  
 Ciseaux vasculaires .....29-33

Clamps Bulldog .....127-128  
 Clamps Bulldog .....57-64  
 Clamps Bulldog atraumatiques .....57-62  
 Clamps bulldog atraumatiques Titane .....62  
 Clef .....50  
 CLEVELAND pinces coupantes à os .....196  
 COOLEY-BECK pinces à anastomose .....133-134  
 COOLEY clamps bulldog .....127-128  
 COOLEY clamps bulldog atraumatiques .....61  
 COOLEY costotomes .....218  
 COOLEY-DERRA pinces à anastomose .....136  
 COOLEY dilateurs pour valve mitrale .....255  
 COOLEY dilateurs vasculaires .....257  
 COOLEY écarteurs atrium .....179  
 COOLEY écarteurs des côtes .....223-225  
 COOLEY modif. STRUCK écarteurs atrium .....180  
 COOLEY pince-clamp à iliaque .....132  
 COOLEY pinces à anastomose .....134-135, 137  
 COOLEY pinces à coarctacion .....131-132  
 COOLEY Pinces atraumatiques .....46  
 COOLEY pinces-clamps polyvalentes 131, 136, 138-139  
 COOLEY pinces-clamps pour des nouveaux-nés  
 et des enfants .....133, 136  
 COOLEY Pinces-clamps pour des nouveaux-nés  
 et des enfants, modèles très fins .....130, 141-142  
 COOLEY pinces pour carotide .....138-139  
 COOLEY Pinces pour sondes .....129  
 COOLEY Tubes d'aspiration .....2  
 CORYLLOS costotomes .....217  
 CORYLLOS écarteurs .....170  
 Costotomes .....215-220  
 CRAFOORD pinces hémostatiques .....81  
 CRILE crochets à nerfs .....252  
 CRILE pinces hémostatiques .....67  
 CRILE-RANKIN pinces hémostatiques .....68  
 CRILE-WOOD porte-aiguilles .....184  
 CUSHING crochets à vaisseaux .....252  
 CUSHING écarteurs .....162  
 CUSHING-KOCHER écarteurs .....164  
 CUSHING Pinces à dissection .....40  
 CUSHING-TAYLOR Pinces à dissection .....40

**D**

DALE pinces-clamps vasculaires périphériques .....114  
 DARDIK pinces-clamps polyvalentes .....96  
 DAVIDSON écarteurs .....171  
 Daviers porte os .....202-203  
 DAVIS dissecteurs à dure-mère .....253  
 DEAYER écarteurs .....159-160  
 DE BAKEY-ADSON Pinces atraumatiques .....47  
 DE BAKEY-BAHNSON pinces-clamps pour  
 aneurysme d'aorte .....103  
 DE BAKEY-BECK pinces-clamps polyvalentes .....115  
 DE BAKEY-CAROTIS clamps bulldog atraumatiques .....57  
 DE BAKEY Ciseaux vasculaires .....32-33  
 DE BAKEY clamps bulldog atraumatiques .....57, 59  
 DE BAKEY-DIETHRICH Pinces atraumatiques .....46  
 DE BAKEY-DIETRICH clamps bulldog atraumatiques .....58  
 DE BAKEY dilateurs vasculaires .....257  
 DE BAKEY écarteurs des côtes .....231, 241-242  
 DE BAKEY-GERALD Pinces atraumatiques .....47

DE BAKEY-HESS clamps bulldog	64
DE BAKEY-MC QUIGGMIXTER pinces à dissection et passe-fil	126
DE BAKEY-MIXTER pinces à dissection et passe-fil	125
DE BAKEY-MORRIS pinces-clamps pour aneurysme d'aorte	105
DE BAKEY pince-clamp à iliaque	100
DE BAKEY pinces à anastomose	118, 123
DE BAKEY pinces à coarctacion	118-119
DE BAKEY pinces à dissection et passe-fil	116
DE BAKEY pinces à passe-fil	123
DE BAKEY Pincas atraumatiques	44-46, 48
DE BAKEY pinces-clamps polyvalentes	106, 109
DE BAKEY pinces-clamps pour anastomoses d'aorte	115
DE BAKEY pinces-clamps pour aneurysme d'aorte	102, 104, 107-108
DE BAKEY pinces-clamps vasculaires périphériques	95, 97
DE BAKEY Pincas vasculaires atraumatiques	89
DE BAKEY porte-aiguilles	185-186
DE BAKEY REYNOLDS pinces à anastomose	121
DE BAKEY-RUMMEL pinces à dissection et passe-fil	125
DE BAKEY-SATINSKY clamps bulldog atraumatiques	57
DE BAKEY-SATINSKY pinces-clamps pour occlusion tangentielle	112
DE BAKEY Titane pinces atraumatiques	45
DE BAKEY Tubes d'aspiration	4
DE BAKEY-WHEELER Pincas atraumatiques	47
DERRA pinces à anastomose	118
DESMARRES ecarteurs	162
DIEFFENBACH clamps bulldog	63
DIETRICH Ciseaux vasculaires	31
DIETRICH clamps bulldog	58
DIETRICH pince-clamp à aorte	122
Dilatateurs pour valve mitrale	255
DOYEN rugines pour le p rioste costale	206-207
DUBOST ecarteurs des côtes	236
DURANTE Pincas à dissection	42
DUVAL pinces à saisir les intestins et les tissus	156

## E

Ecarteurs	159-171
Ecarteurs atrium	179-180
Ecarteurs autostatiques	172-176
Ecarteurs des côtes	222-246
ECHLIN pinces-gouges	196
EDWARDS applicateur pour clips	111
EDWARDS clips	111
Enlève-lame	12

## F

FARABEUF rugines-raspatoires	204
FAVALORO Ciseaux vasculaires	33
FERGUSON daviers porte os	202
Fil à os	210
FINOCHIETTO-BABY ecarteurs des côtes	223
FINOCHIETTO BABY-HAIGHT ecarteurs des côtes	228
FINOCHIETTO BURFORD ecarteurs	230, 232-234
FINOCHIETTO ecarteurs des côtes	222, 227-229
FINOCHIETTO INFANT ecarteurs des côtes	229
FINOCHIETTO (modif.) ecarteurs des côtes	222
FINOCHIETTO pinces à dissection et passe-fil	150

FINOCHIETTO porte-aiguilles	188
FINSTERER Tubes d'aspiration	4
FISCH ecarteurs pour dure-mère	253
FOERSTER pinces à pansements	148
FRAZIER Tubes d'aspiration	6
FREER élévateurs pour cloison	254
FRYKHOLM pinces-gouges	195
FUCHSIG pinces à dissection et à ligatures	76

## G

GEMINI mini pinces à dissection et à ligatures	77
GEMINI pinces à dissection et à ligatures	77
GERALD Pincas à dissection	41
GIERTZ-STILLE costotomes	219
GILLIES erignes	254
GILLIES Pincas à dissection	41
GLASSMAN Pincas atraumatiques	47
GLOVER clamps bulldog atraumatiques	57, 60
GLOVER pinces à anastomose	93-94
GLOVER pinces à coarctacion	91, 120
GLUCK costotomes	216
GOSLEE pinces plates	211
GREGORY clamps bulldog atraumatiques	57
GREGORY pinces-clamps pour profunda	126
GROSS-MAIER pinces à pansements	147

## H

HABERER spatules abdominales	158
HAIGHT ecarteurs des côtes	238
HALLE élévateurs pour cloison	252
HALSEY porte-aiguilles	184
HALSTEAD-MOSQUITO micro pinces hémostatiques	66
HALSTEAD-MOSQUITO pinces hémostatiques	66
HALSTEAD-MOSQUITO Pincas vasculaires atraumatiques	87
HARKEN pinces auriculaires	113
HARRINGTON ecarteurs	161
HARTMANN pinces hémostatiques	65
HARVEY pince coupantes de côte, Pincas à couper le fil	214
HEANEY porte-aiguilles	187
HEGAR-VASCULAR porte-aiguilles	187
HEISS pinces hémostatiques	75
HENLEY ecarteurs autostatiques	173
HERTZLER ecarteurs des côtes	246
HOPT Pincas vasculaires atraumatiques	88

## I

IRIS Ciseaux	28
--------------	----

## J

JAVID pinces pour carotide	123
JOHN-HOPKINS clamps bulldog	63
JONES-CLIP pinces à champs	145
JONES pinces à champs	145
JOSEPH Ciseaux à plastique	26

## K

KADER spatules abdominales	158
KELLY ecarteurs	168

KELLY pinces hémostatiques	67
KELLY-RANKIN pinces hémostatiques	67
KILNER Ciseaux à plastique	27
KILNER erignes	258
KOCHER ecarteurs	164
KOCHER-LANGENBECK ecarteurs	165
KOCHER-NIPPON pinces hémostatiques	72
KOCHER pinces hémostatiques modèle gracile	71
KOENIG ecarteurs	164
KRAYENBÜHL crochets à nerfs	252

**L**

LAMBERT KAY pinces-clamps pour anastomoses	99
LAMBOTTE rugines-raspatoires	204
Lames des bistouris, stériles	11-13
LANGENBECK daviers porte os	202
LANGENBECK ecarteurs	163-164
LANGENBECK rugines-raspatoires	205
LAWRENCE pinces hémostatiques	82
LEBSCHKE ciseau-burin à sternum	204
LEES pinces-clamps à bronches	90
LEKSELL-STILLE pinces-gouges	195
LELAND-JONES pinces-clamps polyvalentes	98
LELAND-JONES pinces-clamps vasculaires périphériques	97
LERICHE pinces hémostatiques	74
LEXER Ciseaux à dissection	23
LEXER-FINO Ciseaux à dissection	22
LICHTENBERG porte-aiguilles	189
LIDDLE pince-clamp à aorte	99
LISTER pinces à pansements	149
LISTON pinces coupantes à os	197
LOVELACE Pinces à saisir le poumon	151
LOVELACE pinces hémostatiques	74

**M**

MAMMARIA ecarteurs des côtes	226
Manches de bistouris	8-10, 13
MARQUARDT pinces-gouges	192
MARTIN ecarteurs	169
MARTIN pinces à pansements	149
MARTIN pinces-clamps vasculaires périphériques	124
MARTIN spatules abdominales	158
MATHIEU porte-aiguilles	188
MAYO Ciseaux à dissection	21
MAYO-HEGAR porte-aiguilles	185
MAYO-STILLE Ciseaux à dissection	22
McINDOE Pinces à dissection	42
MCINDOE pinces coupantes à os	198
McQUIGG-MIXTER pinces hémostatiques	84
MEHDORN Pince pour serre-fines	54
MEHDORN serre-fines - pour occlusion temporaire	54
MERCEDES ecarteurs des côtes	243
METZENBAUM Ciseaux à dissection	24
METZENBAUM FINO Ciseaux à dissection	25
METZENBAUM FINO "S" Ciseaux à dissection	26
METZENBAUM-NELSON Ciseaux à dissection	26
Micro-ciseaux vasculaires	35
Micro lame de bistouris	13
MIKULICZ-Baby pinces a peritoine	85
MIKULICZ ecarteurs	167

MIKULICZ pinces a peritoine	85
MINI Pince pour serre-fines	56
MINI serre-fines - pour occlusion temporaire	55
MIXTER Baby pinces hémostatiques	83
MIXTER-O'SHAUGNESSY pinces hémostatiques	84
MIXTER pinces hémostatiques	83, 84
MORSE STERNAL ecarteurs des côtes	244-245
MORSE STERNAL FAVOROLO ecarteurs des côtes	245
MÜLLER Approximateurs	51
MÜLLER serre-fines - pour occlusion temporaire	52
MURPHY pinces serre-tubes	86

**N**

NABATOFF stripper à varices	248
NELSON Pinces à dissection	42

**O**

OCHSNER pince-clamp à aorte	122
Olive	3
OVERHOLT-BABY pinces à dissection et à ligatures	78
OVERHOLT fino pinces à dissection et à ligatures	79
OVERHOLT-GEISSENDOERFER pinces à dissection et à ligatures	78
OVERHOLT-MIXTER pinces à dissection et à ligatures	80
OVERHOLT pinces à dissection et à ligatures	79, 80

**P**

PEAN-NIPPON pinces hémostatiques	72
PEAN pinces hémostatiques modèle gracile	71
PEAN Pinces vasculaires atraumatiques	87
PEERS BERTRAM pinces à champs	145
Pince à ligatures	65
Pince-clamp à aorte	99, 101, 121-122
Pince-clamp à iliaque	100, 132
Pince coupantes de côte, Pinces à couper le fil	213
Pince pour poser et retirer les clamps Bulldog	63
Pince pour serre-fines	49-51, 53-54, 56
Pinces à anastomose	93-94, 118, 121, 123, 133-137
Pinces à champs	145-146
Pinces à coarctacion	91-92, 117, 118-120, 131-132
Pinces à dissection	38-42
Pinces à dissection et à ligatures	76-80
Pinces à dissection et passe-fil	116, 125-126, 150
Pinces à microchirurgie	43
Pinces à pansements	147-149
Pinces à passe-fil	123
Pinces a peritoine	85
Pinces à saisir les intestins et les tissus	154-156
Pinces à torsader le fil	212
Pinces atraumatiques	43-48
Pinces auriculaires	113
Pinces-Clamps à Bronches	90
Pinces-clamps polyvalentes	96, 98, 106, 109, 115, 131, 136, 138-139
Pinces-clamps pour anastomoses d'aorte	115, 99
Pinces-clamps pour aneurysme d'aorte	102-105, 106-108
Pinces-clamps pour des nouveaux-nés et des enfants	130, 133, 136, 140-144
Pinces-clamps pour occlusion tangentielle	110, 112
Pinces-clamps pour profunda	126



Pincés-clamps vasculaires péricéphiques 114, 124, 95, 97  
 Pincés coupantes à os .....196-201  
 Pincés-gouges .....192-196  
 Pincés hémostatiques .....65-75, 81-84  
 Pincés hémostatiques Titane .....66-67  
 Pincés plates .....210-211  
 Pincés pour carotide .....123, 138-139  
 Pincés serre-tubes .....86  
 Pincés vasculaires atraumatiques .....87-144  
 Pointe de succion .....3  
 POPPEN Tubes d'aspiration .....5  
 Porte-aiguilles .....184-189  
 Porte-ligatures .....256  
 POTTS pincés à coarctacion .....117, 91-92  
 POTTS-SMITH Ciseaux vasculaires .....29-31  
 POTTS-SMITH Pincés à dissection .....38  
 PRESBYTERIAN HOSPITAL pincés serre-tubes .....86  
 PRICE-THOMAS Pincés-clamps à Bronches .....152  
 PROVIDENCE-HOSPITAL pincés hémostatiques .....68

**R**

RANKIN Pincés vasculaires atraumatiques .....88  
 Rapprocheurs de côtes .....177  
 REILL pince coupantes de côte, Pincés à couper le fil 214  
 REYNOLDS Ciseaux .....27  
 RIBBON spatules abdominales .....158  
 ROBB dissecteurs vasculaires .....258  
 ROCHESTER-CARMALT pincés hémostatiques .....73  
 ROCHESTER-OCHSNER pincés hémostatiques .....70  
 ROCHESTER-PEAN pincés hémostatiques .....69  
 Rongeurs pour aorte .....16  
 Rugines-raspatoires .....204-209  
 RUMEL-BELMONT tourniquets .....256  
 RUMMEL pincés hémostatiques .....81  
 RUSKIN LISTON pincés coupantes à os .....198  
 RUSKIN pincés-gouges .....192  
 Russ. Mod. Pincés à dissection .....42  
 RYDER porte-aiguilles .....186

**S**

SANTULLI clamps bulldog atraumatiques .....57  
 SANVENERO Ciseaux .....26  
 SAROT pincés hémostatiques .....81  
 SAROT porte-aiguilles .....188  
 SATINSKY Ciseaux .....34  
 SATINSKY pincés-clamps à anastomose .....153  
 SATINSKY pincés-clamps pour occl. tangentielle .....110  
 SAUERBRUCH ecarteurs .....171  
 SAUERBRUCH pincés-gouges .....194  
 SAUERBUCH costotomes .....219  
 SAUERBUCH-FREY costotomes .....220  
 SCHAEDEL pincés à champs .....145  
 SCHEIBE pincés à saisir les intestins et les tissus .....156  
 SCHMID Aiguilles vasculaires pour irrigation .....5  
 SCHNIDT pincés à dissection et passe-fil .....150  
 SCHUMACHER ciseaux a sternum .....215  
 SELLORS rapprocheurs de côtes .....177  
 SEMB daviens porte os .....203  
 SEMB Pincés-clamps à Bronches .....153  
 SEMB pincés coupantes à os .....201  
 SEMB pincés-gouges .....196

SEMB rugines-raspatoires .....208  
 SEMKEN Pincés à dissection .....41  
 Serre-Fines - pour occlusion temporaire .....52-55  
 SIMON ecarteurs .....169  
 SINGLY Pincés à dissection .....42  
 Spatule pour la tunique interne .....258  
 Spatules abdominales .....158  
 Spatules pulmonaires .....178  
 SPENCER-WELLS pincés hémostatiques .....73  
 STANDARD Pince pour serre-fines .....56  
 STANDARD serre-fines - pour occlusion temporaire .....55  
 STILLE costotomes .....216  
 STILLE HORSLEY pincés coupantes à os .....201  
 STILLE LISTON pincés coupantes à os .....199-200  
 STILLE LUER pincés-gouges .....193-194  
 Stripper à varices .....248-249  
 STRUCK ecarteurs des côtes .....237  
 SUBRAMANIAN-MINIATURE pince-clamp à aorte .....121  
 SUBRAMANIAN pince-clamp à aorte .....121

**T**

Titane pincés à microchirurgie .....43  
 Titane pincés atraumatiques .....44  
 TOENNIS-ADSON Ciseaux .....34  
 TOENNIS dissecteurs à dure-mère .....253  
 TOHOKU pincés à champs .....146  
 TUBBS dilateurs pour valve mitrale .....255  
 Tubes d'aspiration .....2-6  
 TUFFIER ecarteurs des côtes .....240

**U**

ULRICH pincés à pansements .....147

**V**

VARADY instruments pour varices .....251  
 VARADY stripper à varices .....249  
 VOLKMANN ecarteurs .....163  
 VOLLMAR strippers à anneau .....250

**W**

WALTON YANKAUER Tubes d'aspiration .....3  
 WANGENSTEEN Pincés à dissection .....42  
 WANGENSTEEN porte-aiguilles .....187  
 WAUGH Pincés à dissection .....40  
 WEBER pince-clamp à aorte .....101  
 WECKER spatule pour l'iris .....254  
 WEINBERG ecarteurs des côtes .....235  
 WEITLANER ecarteurs autostatiques .....172-175  
 WICKSTROEM pincés hémostatiques .....84  
 WYLIE Pincés vasculaires atraumatiques .....112

**Y**

YANKAUER Tubes d'aspiration .....3

**Z**

ZAUFAL JANSEN pincés-gouges .....192  
 ZENKER ecarteurs .....166  
 ZENKER pincés hémostatiques .....82

**A**

ADSON Baby pinzas para disección y ligaduras .....76  
 ADSON-BABY separadores autostaticos .....175  
 ADSON micro Pinzas de disección .....39  
 ADSON Pinzas de disección .....39  
 ADSON pinzas para disección y ligaduras .....76  
 BECKMANN-ADSON separadores autostaticos .....176  
 ADSON Tubos de aspiración .....5  
 Agujas de rechange .....50  
 ALEXANDER periostótomos .....205  
 Alicates de pico plano .....210-211  
 ALLIS-Atrauma pinzas para coger intestinos y tejidos154  
 ALLISON espátulas pulmonares .....178  
 ALLIS pinzas para coger intestinos y tejidos .....154  
 ALLPORT separadores autostaticos .....172  
 ALM separadores autostaticos .....172  
 Aproximadores .....49-51  
 Aproximadores para costillas .....177

**B**

BABCOCK-Atrauma pinzas para coger intestinos .....155  
 BABCOCK pinzas para coger intestinos y tejidos .....155  
 BABY-CRILE-WOOD porta-agujas .....184  
 Baby MIXTER pinzas hemostáticas .....82  
 BACKHAUS pinzas para campos .....145  
 BADGLEY separadores costales .....239  
 BAILEY aproximadores para costillas .....177  
 BAILEY-BABY aproximadores para costillas .....177  
 BAILEY-GIBBON aproximadores para costillas .....177  
 BAINBRIDGE pinzas clamps para usos varios .....98  
 BALL AND SOCKET pinzas para campos .....146  
 BENGOLEA pinzas hemostáticas .....75  
 BAUMGARTNER pinzas para torcer alambre .....212  
 BECKMANN separadores autostaticos .....176  
 BECK pinzas clamps para usos varios .....115  
 BERLIN pinzas cierra-tubos .....86  
 BETHUNE costótomos .....218  
 BEYER pinzas-gubias .....192  
 BIEMER Aproximadores .....50  
 BIEMER clips vasculares - para oclusión temporal .....53  
 BIEMER - MÜLLER Aproximadores .....49  
 BIEMER Pinza de resorte para clips .....49-51, 53  
 Bisturíes uso único, estériles .....14-15  
 BLAKE pinzas para los cálculos biliares .....153  
 BOEHLER pinzas cortantes para hueso .....197  
 BOROWSKI Separadores para aorta .....181  
 BRAUN-STADTLER Tijeras de esternón .....34  
 BROM separador para venas .....252  
 BRUNNER costótomos .....220

**C**

Cabezal para aspiración .....3  
 CASTAÑEDA Pinzas clamps para recién nacidos  
 y niños, modelos muy finos .....140, 143-144  
 CASTAÑEDA separadores costales .....235  
 CASTROVIEJO porta-agujas .....189  
 Clamps Bulldog .....57-64  
 Clamps Bulldog .....127-128  
 Clamps Bulldog atraumáticas .....57-62  
 Clamps bulldog atraumáticas titanio .....62

CLEVELAND pinzas cortantes para hueso .....196  
 Clips vasculares - para oclusión temporal .....52-55  
 COOLEY-BECK pinzas para anastomosis .....133-134  
 COOLEY clamps bulldog .....127-128  
 COOLEY clamps bulldog atraumáticas .....61  
 COOLEY costótomos .....218  
 COOLEY-DERRA pinzas para anastomosis .....136  
 COOLEY dilatadores para válvula mitral .....255  
 COOLEY dilatadores vasculares .....257  
 COOLEY modif. STRUCK separadores atrium .....180  
 COOLEY pinzas para shunt carótido .....138-139  
 COOLEY pinza clamp para iliaca .....132  
 COOLEY Pinzas atraumáticas .....46  
 COOLEY pinzas clamps para recién nacidos .....133, 136  
 COOLEY Pinzas clamps para recién nacidos y niños,  
 modelos muy finos .....130, 141-142  
 COOLEY pinzas clamps usos varios .....131, 136, 138-139  
 COOLEY pinzas para anastomosis .....134-135, 137  
 COOLEY Pinzas para catéteres .....129  
 COOLEY pinzas para coarctación .....131-132  
 COOLEY separadores atrium .....179  
 COOLEY separadores costales .....223-225  
 COOLEY Tubos de aspiración .....2  
 CORYLLOS costótomos .....217  
 CORYLLOS separadores .....170  
 Costótomos .....215-220  
 CRAFOORD pinzas hemostáticas .....81  
 CRILE ganchos para nervios .....252  
 CRILE pinzas hemostáticas .....67  
 CRILE-RANKIN pinzas hemostáticas .....68  
 CRILE-WOOD porta-agujas .....184  
 CUSHING ganchos para vasos .....252  
 CUSHING-KOCHER separadores .....164  
 CUSHING Pinzas de disección .....40  
 CUSHING separadores .....162  
 CUSHING-TAYLOR Pinzas de disección .....40

**D**

DALE pinzas para vasos periféricos .....114  
 DARDIK pinzas clamps para usos varios .....96  
 DAVIDSON separadores .....171  
 DAVIS disecadores para duramadre .....253  
 DEEVER separadores .....159-160  
 DE BAKEY-ADSON Pinzas atraumáticas .....47  
 DE BAKEY-BAHNSON pinzas clamps  
 para aneurisma de aorta .....103  
 DE BAKEY-BECK pinzas clamps para usos varios .....115  
 DE BAKEY-CAROTIS clamps bulldog atraumáticas .....57  
 DE BAKEY clamps bulldog atraumáticas .....57, 59  
 DE BAKEY-DIETRICH Pinzas atraumáticas .....46  
 DE BAKEY-DIETRICH clamps bulldog atraumáticas .....58  
 DE BAKEY dilatadores vasculares .....257  
 DE BAKEY-GERALD Pinzas atraumáticas .....47  
 DE BAKEY-HESS clamps bulldog .....64  
 DE BAKEY-MC QUIGGMIXTER pinzas de disección y  
 para ligaduras .....126  
 DE BAKEY-MIXTER pinzas de disección y  
 para ligaduras .....125  
 DE BAKEY-MORRIS pinzas clamps para aneurisma de  
 aorta .....105  
 DE BAKEY pinza clamp para iliaca .....100

DE BAKEY Pinzas atraumáticas ..... 44-46, 48  
 DE BAKEY pinzas clamps para anastomosis de aorta 115  
 DE BAKEY pinzas clamps para aneurisma de aorta ..... 102, 104, 107-108  
 DE BAKEY pinzas clamps para usos varios ... 106, 109  
 DE BAKEY pinzas de disección y para ligaduras ... 116  
 DE BAKEY pinzas para anastomosis ..... 118, 123  
 DE BAKEY pinzas para coarctación ..... 118-119  
 DE BAKEY pinzas para ligaduras ..... 123  
 DE BAKEY pinzas para vasos periféricos ..... 95, 97  
 DE BAKEY Pinzas vasculares atraumáticas ..... 89  
 DE BAKEY porta-agujas ..... 185-186  
 DE BAKEY REYNOLDS pinzas para anastomosis .. 121  
 DE BAKEY-RUMMEL pinzas de disección y para ligaduras ..... 125  
 DE BAKEY-SATINSKY clamps bulldog atraumáticas . 57  
 DE BAKEY-SATINSKY pinzas para oclusión ..... 112  
 DE BAKEY separadores costales ..... 231, 241-242  
 DE BAKEY Tijeras vasculares ..... 32-33  
 DE BAKEY Titanio pinzas atraumáticas ..... 45  
 DE BAKEY Tubos de aspiración ..... 4  
 DE BAKEY-WHEELER Pinzas atraumáticas ..... 47  
 DERRA pinzas para anastomosis ..... 118  
 DESMARRES separadores ..... 162  
 DIEFFENBACH clamps bulldog ..... 63  
 DIETRICH Tijeras vasculares ..... 31  
 DIETRICH clamps bulldog ..... 58  
 DIETRICH pinza clamp para aorta ..... 122  
 Dilatadores para válvula mitral ..... 255  
 DOYEN legras costales ..... 206-207  
 DUBOST separadores costales ..... 236  
 DURANTE Pinzas de disección ..... 42  
 DUVAL pinzas para coger intestinos y tejidos ..... 156

**E**

ECHLIN pinzas-gubias ..... 196  
 EDWARDS clips ..... 111  
 EDWARDS pinza para aplicar clips ..... 111  
 Espátula para la íntima ..... 258  
 Espátulas abdominales ..... 158  
 Espátulas pulmonares ..... 178

**F**

FARABEU peristótomos ..... 204  
 FAVALORO Tijeras vasculares ..... 33  
 FERGUSSON pinzas para huesos ..... 202  
 FINOCHIETTO BABY-HAIGHT separadores costales 228  
 FINOCHIETTO-BABY separadores costales ..... 223  
 FINOCHIETTO BURFORD separadores costales ..... 230, 232-234  
 FINOCHIETTO INFANT separadores costales ..... 229  
 FINOCHIETTO (modif.) separadores costales ..... 222  
 FINOCHIETTO pinzas de disección y para ligaduras 150  
 FINOCHIETTO porta-agujas ..... 188  
 FINOCHIETTO separadores costales ..... 222, 227-229  
 FINSTERER Tubos de aspiración ..... 4  
 FISCH separadores para duramadre ..... 253  
 FOERSTER pinzas para tapones ..... 148  
 FRAZIER Tubos de aspiración ..... 6  
 FREER elevadores para tabique ..... 254  
 FRYKHOLM pinzas-gubias ..... 195

FUCHSIG pinzas para disección y ligaduras ..... 76

**G**

GEMINI mini pinzas para disección y ligaduras ..... 77  
 GEMINI pinzas para disección y ligaduras ..... 77  
 GERALD Pinzas de disección ..... 41  
 GIERTZ-STILLE costótomos ..... 219  
 GILLIES ganchitos ..... 254  
 GILLIES Pinzas de disección ..... 41  
 GLASSMAN Pinzas atraumáticas ..... 47  
 GLOVER clamps bulldog atraumáticas ..... 57, 60  
 GLOVER pinzas para anastomosis ..... 93-94  
 GLOVER pinzas para coarctación ..... 91, 120  
 GLUCK costótomos ..... 216  
 GOSLEE alicates de pico plano ..... 211  
 GREGORY clamps bulldog atraumáticas ..... 57  
 GREGORY pinzas clamps para profunda ..... 126  
 GROSS-MAIER pinzas para tapones ..... 147

**H**

HABERER espátulas abdominales ..... 158  
 HAIGHT separadores costales ..... 238  
 HALLE elevadores para tabique ..... 252  
 HALSEY porta-agujas ..... 184  
 HALSTEAD-MOSQUITO micro pinzas hemostáticas . 66  
 HALSTEAD-MOSQUITO pinzas hemostáticas ..... 66  
 HALSTEAD-MOSQUITO Pinzas atraumáticas ..... 87  
 HARKEN pinzas para aurícula ..... 113  
 HARRINGTON separadores ..... 161  
 HARTMANN pinzas hemostáticas ..... 65  
 HARVEY tenazas de corte lateral ..... 214  
 HEANEY porta-agujas ..... 187  
 HEGAR-VASCULAR porta-agujas ..... 187  
 HEISS pinzas hemostáticas ..... 75  
 HENLEY separadores autostáticos ..... 173  
 HERTZLER separadores costales ..... 246  
 Hilo para huesos ..... 210  
 Hojas de bisturíes estériles ..... 11-13  
 HOPT Pinzas vasculares atraumáticas ..... 88

**I**

IRIS Tijeras ..... 28

**J**

JAVID pinzas para shunt carótido ..... 123  
 JOHN-HOPKINS clamps bulldog ..... 63  
 JONES-CLIP pinzas para campos ..... 145  
 JONES pinzas para campos ..... 145  
 JOSEPH Tijeras de plástica ..... 26

**K**

KADER espátulas abdominales ..... 158  
 KELLY pinzas hemostáticas ..... 67  
 KELLY-RANKIN pinzas hemostáticas ..... 67  
 KELLY separadores ..... 168  
 KILNER ganchitos ..... 258  
 KILNER Tijeras de plástica ..... 27  
 KOCHER-LANGENBECK separadores ..... 165  
 KOCHER-NIPPON pinzas hemostáticas ..... 72  
 KOCHER pinzas hemostáticas modelo delicado .... 71

KOCHER separadores .....164  
 KOENIG separadores .....164  
 KRAYENBUHL ganchos para nervios .....252

**L**

LAMBERT KAY pinzas clamps para anastomosis ... .99  
 LAMBOTTE periostótomos .....204  
 LANGENBECK periostótomos .....205  
 LANGENBECK pinzas para huesos .....202  
 LANGENBECK separadores .....163-164  
 LAWRENCE pinzas hemostáticas .....82  
 LEBSCHKE cinceles .....204  
 LEES pinzas clamps bronquiales .....90  
 LEKSELL-STILLE pinzas-gubias .....195  
 LELAND-JONES pinzas clamps para usos varios ... .98  
 LELAND-JONES pinzas para vasos periféricos ... .97  
 LERICHE pinzas hemostáticas .....74  
 LEXER-FINO Tijeras de disección .....22  
 LEXER Tijeras de disección .....23  
 LICHTENBERG porta-agujas .....189  
 LIDDLE pinza clamp para aorta .....99  
 LISTER pinzas para tapones .....149  
 LISTON pinzas cortantes para hueso .....197  
 Llave .....50  
 LOVELACE pinzas hemostáticas .....74  
 LOVELACE Pinzas para coger el pulmón .....151

**M**

MAMMARIA separadores costales .....226  
 Mangos de bisturíes .....8-10, 13  
 MARQUARDT pinzas-gubias .....192  
 MARTIN espátulas abdominales .....158  
 MARTIN pinzas para tapones .....149  
 MARTIN pinzas para vasos periféricos .....124  
 MARTIN separadores .....169  
 MATHIEU porta-agujas .....188  
 MAYO-HEGAR porta-agujas .....185  
 MAYO-STILLE Tijeras de disección .....22  
 MAYO Tijeras de disección .....21  
 MCINDOE pinzas cortantes para hueso .....198  
 McINDOE Pinzas de disección .....42  
 McQUIGG-MIXTER pinzas hemostáticas .....84  
 MEHDORN clips vasculares - para oclusión temporal 54  
 MEHDORN Pinza de resorte para clips .....54  
 MERCEDES separadores costales .....243  
 METZENBAUM FINO "S" Tijeras de disección .....26  
 METZENBAUM FINO Tijeras de disección .....25  
 METZENBAUM-NELSON Tijeras de disección .....26  
 METZENBAUM Tijeras de disección .....24  
 Micro hojas de bisturí .....13  
 MIKULICZ-Baby pinzas para peritoneo .....85  
 MIKULICZ pinzas para peritoneo .....85  
 MIKULICZ separadores .....167  
 MINI clips vasculares - para oclusión temporal .....55  
 MINI Pinza de resorte para clips .....56  
 MIXTER Baby pinzas hemostáticas .....83  
 MIXTER-O'SHAUGNESSY pinzas hemostáticas ... .84  
 MIXTER pinzas hemostáticas .....83, 84  
 MORSE STERNAL FAVOLORO separadores costales245  
 MORSE STERNAL separadores costales .....244-245  
 MÜLLER Aproximadores .....51

MÜLLER clips vasculares - para oclusión temporal .52  
 MURPHY pinzas cierra-tubos .....86

**N**

NABATOFF sondas para várices .....248  
 NELSON Pinzas de disección .....42

**O**

OCHSNER pinza clamp para aorta .....122  
 Oliva .....3  
 OVERHOLT-BABY pinzas para disección y ligaduras .78  
 OVERHOLT fino pinzas para disección y ligaduras .79  
 OVERHOLT-GEISSENDOERFER pinzas para disección y ligaduras .....78  
 OVERHOLT-MIXTER pinzas para disección y ligaduras80  
 OVERHOLT pinzas para disección y ligaduras ... .79, 80

**P**

PEAN-NIPPON pinzas hemostáticas .....72  
 PEAN pinzas hemostáticas modelo delicado .....71  
 PEAN Pinzas vasculares atraumáticas .....87  
 PEERS BERTRAM pinzas para campos .....145  
 Perforadores aórticos .....16  
 Periostótomos .....204-209  
 Pincas para shunt carótido .....123, 138-139  
 Pinza clamp para aorta .....99, 101, 121-122  
 Pinza clamp para iliaca .....100, 132  
 Pinza de resorte para clips .....49-51, 53-54, 56  
 Pinza para hilos .....65  
 Pinza para poner y quitar clamps Bulldog .....63  
 Pinzas atraumáticas .....43-48  
 Pinzas cierra-tubos .....86  
 Pinzas clamps bronquiales .....90  
 Pinzas clamps para anastomosis de aorta ... .99, 115  
 Pinzas clamps para aneurisma de aorta102-105, 106-108  
 Pinzas clamps para profunda .....126  
 Pinzas clamps para recién nacidos y niños .....130, 133, 136, 140-144  
 Pinzas clamps para usos varios .....96, 98, 106, 109, 115, 131, 136, 138-139  
 Pinzas cortantes para hueso .....196-201  
 Pinzas de disección .....38-42  
 Pinzas de disección y para ligaduras .116, 125-126, 150  
 Pinzas-gubias .....192-196  
 Pinzas hemostáticas .....65-75, 81-84  
 Pinzas hemostáticas titanio .....66-67  
 Pinzas para anastomosis 93-94, 118, 121, 123, 133-137  
 Pinzas para aurícula .....113  
 Pinzas para campos .....145-146  
 Pinzas para coarctación .91-92, 117, 118-120, 131-132  
 Pinzas para coger intestinos y tejidos .....154-156  
 Pinzas para disección y ligaduras .....76-80  
 Pinzas para huesos .....202-203  
 Pinzas para ligaduras .....123  
 Pinzas para microcirugía .....43  
 Pinzas para oclusión tangencial .....110, 112  
 Pinzas para peritoneo .....85  
 Pinzas para tapones .....147-149  
 Pinzas para tejidos y órganos .....114  
 Pinzas para torcer alambre .....212



Pinzas para vasos periféricos . . . . .95, 97, 114, 124  
 Pinzas vasculares atraumáticas . . . . .87-144  
 POPPEN Tubos de aspiración . . . . .5  
 Porta-agujas . . . . .184-189  
 Portas ligaduras . . . . .256  
 POTTS pinzas para coarctación . . . . .91-92, 117  
 POTTS-SMITH Pinzas de disección . . . . .38  
 POTTS-SMITH Tijeras vasculares . . . . .29-31  
 PRESBYTERIAN HOSPITAL pinzas cierra-tubos . . .86  
 PRICE-THOMAS Pinzas clamps bronquiales . . .152  
 PROVIDENCE-HOSPITAL pinzas hemostáticas . . .68

**Q**

Quita hojas . . . . .12

**R**

RANKIN Pinzas vasculares atraumáticas . . . . .88  
 REILL tenazas de corte lateral . . . . .214  
 REYNOLDS Tijeras . . . . .27  
 RIBBON espátulas abdominales . . . . .158  
 ROBB disecadores vasculares . . . . .258  
 ROCHESTER-CARMALT pinzas hemostáticas . . .73  
 ROCHESTER-OCHSNER pinzas hemostáticas . . .70  
 ROCHESTER-PEAN pinzas hemostáticas . . . . .69  
 RUMEL-BELMONT tourniquetes . . . . .256  
 RUMMEL pinzas hemostáticas . . . . .81  
 RUSKIN LISTON pinzas cortantes para hueso . . .198  
 RUSKIN pinzas-gubias . . . . .192  
 Russ. Mod. Pinzas de disección . . . . .42  
 RYDER porta-agujas . . . . .186

**S**

SANTULLI clamps bulldog atraumáticas . . . . .57  
 SANVENERO Tijeras . . . . .26  
 SAROT pinzas hemostáticas . . . . .81  
 SAROT porta-agujas . . . . .188  
 SATINSKY pinzas clamps para anastomosis . . .153  
 SATINSKY pinzas para oclusión tangencial . . .110  
 SATINSKY Tijeras . . . . .34  
 SAUERBRUCH pinzas-gubias . . . . .194  
 SAUERBRUCH separadores . . . . .171  
 SAUERBUCH costótomos . . . . .219  
 SAUERBUCH-FREY costótomos . . . . .220  
 SCHAEDEL pinzas para campos . . . . .145  
 SCHEIBE pinzas para coger intestinos y tejidos . .156  
 SCHMID Canulas vasculares para irrigación . . . .5  
 SCHNIDT pinzas de disección y para ligaduras . .150  
 SCHUMACHER tijera de esternón . . . . .215  
 SELLORS aproximadores para costillas . . . . .177  
 SEMB periostótomos . . . . .208  
 SEMB Pinzas clamps bronquiales . . . . .153  
 SEMB pinzas cortantes para hueso . . . . .201  
 SEMB pinzas-gubias . . . . .196  
 SEMB pinzas para huesos . . . . .203  
 SEMKEN Pinzas de disección . . . . .41  
 Separadores . . . . .159-171  
 Separadores atrium . . . . .179-180  
 Separadores autostatiques . . . . .172-176  
 Separadores costales . . . . .222-246  
 SIMON separadores . . . . .169

SINGLY Pinzas de disección . . . . .42  
 Sondas para várices . . . . .248-249  
 SPENCER-WELLS pinzas hemostáticas . . . . .73  
 STANDARD clips vasculares - para oclusión temporal55  
 STANDARD Pinza de resorte para clips . . . . .56  
 STILLE costótomos . . . . .216  
 STILLE HORSLEY pinzas cortantes para hueso . .201  
 STILLE LISTON pinzas cortantes para hueso . .199-200  
 STILLE LUER pinzas-gubias . . . . .193-194  
 STRUCK separadores costales . . . . .237  
 SUBRAMANIAN-MINIATURE pinza clamp para aorta121  
 SUBRAMANIAN pinza clamp para aorta . . . . .121

**T**

Tenazas de corte lateral, Alicates para cortat alambre213  
 Tijara para preparación del nervio . . . . .34  
 Tijeras . . . . .26-28, 34  
 Tijeras de disección . . . . .21-25  
 Tijeras microquirúrgicas vasculares . . . . .35  
 Tijeras para cirugía . . . . .18-20  
 Tijeras vasculares . . . . .29-33  
 Titanio pinzas atraumáticas . . . . .44  
 Titanio pinzas para microcirugía . . . . .43  
 TOENNIS-ADSON Tijeras . . . . .34  
 TOENNIS disecadores para duramadre . . . . .253  
 TOHOKU pinzas para campos . . . . .146  
 TUBBS dilatadores para válvula mitral . . . . .255  
 Tubos de aspiración . . . . .2-6  
 TUFFIER separadores costales . . . . .240

**U**

ULRICH pinzas para tapones . . . . .147

**V**

VARADY instrumentos para varices . . . . .251  
 VARADY sondas para várices . . . . .249  
 VOLKMANN separadores . . . . .163  
 VOLLMAR fleboextractores . . . . .250

**W**

WALTON YANKAUER Tubos de aspiración . . . . .3  
 WANGENSTEEN Pinzas de disección . . . . .42  
 WANGENSTEEN porta-agujas . . . . .187  
 WAUGH Pinzas de disección . . . . .40  
 WEBER pinza clamp para aorta . . . . .101  
 WECKER espátula para iris . . . . .254  
 WEINBERG separadores costales . . . . .235  
 WEITLANER separadores autostatiques . . . . .172-175  
 WICKSTROEM pinzas hemostáticas . . . . .84  
 WYLIE Pinzas vasculares atraumáticas . . . . .112

**Y**

YANKAUER Tubos de aspiración . . . . .3

**Z**

ZAUFAL JANSEN pinzas-gubias . . . . .192  
 ZENKER pinzas hemostáticas . . . . .82  
 ZENKER separadores . . . . .166

**A**

ADSON-BABY divaricatori autostatici	175
ADSON Baby pinze per dissezione e per legature	76
BECKMANN-ADSON divaricatori autostatici	176
ADSON micro Pinze per dissezione	39
ADSON Pinze per dissezione	39
ADSON pinze per dissezione e per legature	76
ADSON Tubi d'aspirazione	5
Aghi di ricambio	50
ALEXANDER periostotomi	205
ALLIS-Atrauma pinze per afferrare intestini e tessuti	154
ALLISON spatole per polmone	178
ALLIS pinze per afferrare intestini e tessuti	154
ALLPORT divaricatori autostatici	172
ALM divaricatori autostatici	172
Applicatore per pinze	49-51, 53-54, 56
Approssimatori	49-51
Approssimatori costali	177

**B**

BABCOCK-Atrauma pinze per afferrare intestini	155
BABCOCK pinze per afferrare intestini e tessuti	155
BABY-CRILE-WOOD port'aghi	184
Baby MIXTER pinze emostatiche	82
BACKHAUS pinze fissateli	145
BADGLEY divaricatori costali	239
BAILEY approssimatori costali	177
BAILEY-BABY approssimatori costali	177
BAILEY-GIBBON approssimatori costali	177
BAINBRIDGE pinze atraumatiche per diversi usi	98
BALL AND SOCKET pinze fissateli	146
BENGOLEA pinze emostatiche	75
BAUMGARTNER pinze per ritorcere fili	212
BECKMANN divaricatori autostatici	176
BECK pinze atraumatiche per diversi usi	115
BERLIN pinze serretubi	86
BETHUNE costotomi	218
BEYER pinze sgorbie	192
BIEMER Applicatore per pinze	49-51, 53
BIEMER Approssimatori	50
BIEMER - MÜLLER Approssimatori	49
BIEMER pinze - per occlusioni temporari	53
Bisturi monouso, sterili	14-15
BLAKE pinze per calcoli biliari	153
BOEHLER cesoie per ossa	197
BOROWSKI Divaricatori per aorta	181
BRAUN-STADTLER Forbici per sterno	34
BROM divaricatore per vene	252
BRUNNER costotomi	220

**C**

CASTAÑEDA divaricatori costali	235
CASTAÑEDA Pinze pediatriche, modelli molto fini	140, 143-144
CASTROVIEJO port'aghi	189
Cesoie per ossa	196-201
CLEVELAND cesoie per ossa	196
COOLEY-BECK pinze per anastomosi	133-134
COOLEY costotomi	218
COOLEY-DERRA pinze per anastomosi	136

COOLEY dilatatori per valvole mitrali	255
COOLEY dilatatori vascolari	257
COOLEY divaricatori costali	223-225
COOLEY divaricatori per cavità	179
COOLEY modif. STRUCK divaricatori per cavità	180
COOLEY pinza per iliaca	132
COOLEY Pinze atraumatiche	46
COOLEY pinze atraumatiche per diversi usi	131, 136, 138-139
COOLEY pinze bulldog	127-128
COOLEY pinze bulldog atraumatiche	61
COOLEY pinze carotis	138-139
COOLEY pinze pediatriche	133, 136
COOLEY Pinze pediatriche, modelli molto fini	130, 141-142
COOLEY pinze per anastomosi	134-135, 137
COOLEY Pinze per cateteri	129
COOLEY pinze per coartazione	131-132
COOLEY Tubi d'aspirazione	2
CORYLLOS costotomi	217
CORYLLOS divaricatori	170
Costotomi	215-220
CRAFOORD pinze emostatiche	81
CRILE pinze emostatiche	67
CRILE-RANKIN pinze emostatiche	68
CRILE uncini per nervi	252
CRILE-WOOD port'aghi	184
CUSHING divaricatori	162
CUSHING-KOCHER divaricatori	164
CUSHING Pinze per dissezione	40
CUSHING-TAYLOR Pinze per dissezione	40
CUSHING uncini per vasi	252

**D**

DALE pinze vascolari periferali	114
DARDIK pinze atraumatiche per diversi usi	96
DAVIDSON divaricatori	171
DAVIS dissestori per la dura-madre	253
DEAVER divaricatori	159-160
DE BAKEY-ADSON Pinze atraumatiche	47
DE BAKEY-BAHNSON pinze per aneurisma di aorta	103
DE BAKEY-BECK pinze atraumatiche per diversi usi	115
DE BAKEY-CAROTIS pinze bulldog atraumatiche	57
DE BAKEY-DIETRICH Pinze atraumatiche	46
DE BAKEY-DIETRICH pinze bulldog atraumatiche	58
DE BAKEY dilatatori vascolari	257
DE BAKEY divaricatori costali	231, 241-242
DE BAKEY Forbici vascolari	32-33
DE BAKEY-GERALD Pinze atraumatiche	47
DE BAKEY-HESS pinze bulldog	64
DE BAKEY-MC QUIGGMIXTER pinze per dissezione e per legature	126
DE BAKEY-MIXTER pinze per dissezione e per legature	125
DE BAKEY-MORRIS pinze per aneurisma di aorta	105
DE BAKEY pinza per iliaca	100
DE BAKEY pinze aortiche	115
DE BAKEY Pinze atraumatiche	44-46, 48
DE BAKEY pinze atraumatiche per diversi usi	106, 109
DE BAKEY pinze bulldog atraumatiche	57, 59
DE BAKEY pinze per anastomosi	118, 123
DE BAKEY pinze per aneurisma di aorta	102, 104, 107-108

DE BAKEY pinze per coartazione	118-119
DE BAKEY pinze per dissezione e per legature	116
DE BAKEY pinze per legature	123
DE BAKEY Pinze vascolari atraumatiche	89
DE BAKEY pinze vascolari periferali	95, 97
DE BAKEY port'aghi	185-186
DE BAKEY REYNOLDS pinze per anastomosi	121
DE BAKEY-RUMMEL pinze per dissezione e per legature	125
DE BAKEY-SATINSKY pinze bulldog atraumatiche	57
DE BAKEY-SATINSKY pinze per occlusione tangenziale	112
DE BAKEY Titanio pinze atraumatiche	45
DE BAKEY Tubi d'aspirazione	4
DE BAKEY-WHEELER Pinze atraumatiche	47
DERRA pinze per anastomosi	118
DESMARRES divaricatori	162
DIEFFENBACH pinze bulldog	63
DIETRICH Forbici vascolari	31
DIETRICH pinza per aorta	122
DIETRICH pinze bulldog	58
Dilatatori per valvole mitrali	255
Distributore lame	12
Divaricatori	159-171
Divaricatori autostatici	172-176
Divaricatori costali	222-246
Divaricatori per cavità	179-180
DOYEN periostotomi costali	206-207
DUBOST divaricatori costali	236
DURANTE Pinze per dissezione	42
DUVAL pinze per afferrare intestini e tessuti	156

**E**

ECHLIN pinze sgorbie	196
EDWARDS applicatore per clips	111
EDWARDS clips	111

**F**

FARABEUF periostotomi	204
FAVALORO Forbici vascolari	33
FERGUSON tenaglie per ossa	202
Filo per ossa	210
FINOCHIETTO-BABY divaricatori costali	223
FINOCHIETTO BABY-HAIGHT divaricatori costali	228
FINOCHIETTO BURFORD divaricatori costali	230, 232-234
FINOCHIETTO divaricatori costali	222, 227-229
FINOCHIETTO INFANT divaricatori costali	229
FINOCHIETTO (modif.) divaricatori costali	222
FINOCHIETTO pinze per dissezione e per legature	150
FINOCHIETTO port'aghi	188
FINSTERER Tubi d'aspirazione	4
FISCH Uncinetto per dura-madre	253
FOERSTER pinze per medicatura	148
Forbici	26-28, 34
Forbici micro-chirurgici vascolari	35
Forbici per chirurgia	18-20
Forbici per dissezione	21-25
Forbici per preparazione di nervi	34
Forbici vascolari	29-33
FRAZIER Tubi d'aspirazione	6
FREER elevatori per setto	254

FRYKHOLM pinze sgorbie	195
FUCHSIG pinze per dissezione e per legature	76

**G**

GEMINI mini pinze per dissezione e per legature	77
GEMINI pinze per dissezione e per legature	77
GERALD Pinze per dissezione	41
GIERTZ-STILLE costotomi	219
GILLIES Pinze per dissezione	41
GILLIES uncini	254
GLASSMAN Pinze atraumatiche	47
GLOVER pinze bulldog atraumatiche	57, 60
GLOVER pinze per anastomosi	93-94
GLOVER pinze per coartazione	91, 120
GLUCK costotomi	216
GOSLEE tenaglie piatte	211
GREGORY pinze bulldog atraumatiche	57
GREGORY pinze per profunda	126
GROSS-MAIER pinze per medicatura	147

**H**

HABERER spatole addominali	158
HAIGHT divaricatori costali	238
HALLE elevatori per setto	252
HALSEY port'aghi	184
HALSTEAD-MOSQUITO micro pinze emostatiche	66
HALSTEAD-MOSQUITO pinze emostatiche	66
HALSTEAD-MOSQUITO Pinze vascolari atraumatiche	87
HARKEN pinze ventricolari	113
HARRINGTON divaricatori	161
HARTMANN pinze emostatiche	65
HARVEY tenaglie tagliafilari laterali, tenaglie tagliafilari	214
HEANEY port'aghi	187
HEGAR-VASCULAR port'aghi	187
HEISS pinze emostatiche	75
HENLEY divaricatori autostatici	173
HERTZLER divaricatori costali	246
HOPT Pinze vascolari atraumatiche	88

**I**

IRIS Forbici	28
--------------	----

**J**

JAVID pinze carotis	123
JOHN-HOPKINS pinze bulldog	63
JONES-CLIP pinze fissateli	145
JONES pinze fissateli	145
JOSEPH Forbici per plastica	26

**K**

KADER spatole addominali	158
KELLY divaricatori	168
KELLY pinze emostatiche	67
KELLY-RANKIN pinze emostatiche	67
KILNER Forbici per plastica	27
KILNER uncini	258
KOCHER divaricatori	164
KOCHER-LANGENBECK divaricatori	165
KOCHER-NIPPON pinze emostatiche	72
KOCHER pinze emostatiche modello delicato	71

KOENIG divaricatori	164
KRAYENBÜHL uncinii per nervi	252

**L**

LAMBERT KAY pinze aortiche	99
LAMBOTTE periostotomi	204
Lame da bisturi, sterili	11-13
LANGENBECK divaricatori	163-164
LANGENBECK periostotomi	205
LANGENBECK tenaglie per ossa	202
LAWRENCE pinze emostatiche	82
LEBSCHKE scalpello per sterno	204
LEES pinze per bronchi	90
LEKSELL-STILLE pinze sgorbie	195
LELAND-JONES pinze atraumatiche per diversi usi	98
LELAND-JONES pinze vascolari periferali	97
LERICHE pinze emostatiche	74
LEXER-FINO Forbici per dissezione	22
LEXER Forbici per dissezione	23
LICHTENBERG port'aghi	189
LIDDLE pinza per aorta	99
LISTER pinze per medicatura	149
LISTON cesoie per ossa	197
LOVELACE pinze emostatiche	74
LOVELACE Pinze per afferrare il polmone	151

**M**

MAMMARIA divaricatori costali	226
Manici per bisturi	8-10, 13
MARQUARDT pinze sgorbie	192
MARTIN divaricatori	169
MARTIN pinze per medicatura	149
MARTIN pinze vascolari periferali	124
MARTIN spatole addominali	158
MATHIEU port'aghi	188
MAYO Forbici per dissezione	21
MAYO-HEGAR port'aghi	185
MAYO-STILLE Forbici per dissezione	22
MCINDOE cesoie per ossa	198
McINDOE Pinze per dissezione	42
McQUIGG-MIXTER pinze emostatiche	84
MEHDORN Applicatore per pinze	54
MEHDORN pinze - per occlusioni temporari	54
MERCEDES divaricatori costali	243
METZENBAUM FINO Forbici per dissezione	25
METZENBAUM FINO "S" Forbici per dissezione	26
METZENBAUM Forbici per dissezione	24
METZENBAUM-NELSON Forbici per dissezione	26
Micro lame per bisturi	13
MIKULICZ-Baby pinze per peritoneo	85
MIKULICZ divaricatori	167
MIKULICZ pinze per peritoneo	85
MINI Applicatore per pinze	56
MINI pinze - per occlusioni temporari	55
MIXTER Baby pinze emostatiche	83
MIXTER-O'SHAUGNESSY pinze emostatiche	84
MIXTER pinze emostatiche	83, 84
MORSE STERNAL divaricatori costali	244-245
MORSE STERNAL FAVOLORO divaricatori costali	245
MÜLLER Approssimatori	51
MÜLLER pinze - per occlusioni temporari	52

MURPHY pinze serretubi	86
------------------------	----

**N**

NABATOFF sonde per vein	248
NELSON Pinze per dissezione	42

**O**

OCHSNER pinza per aorta	122
Oliva	3
OVERHOLT-BABY pinze per dissezione e per legature	78
OVERHOLT fino pinze per dissezione e per legature	79
OVERHOLT-GEISSENDOERFER pinze per dissezione e per legature	78
OVERHOLT-MIXTER pinze per dissezione e per legature	80
OVERHOLT pinze per dissezione e per legature	79, 80

**P**

PEAN-NIPPON pinze emostatiche	72
PEAN pinze emostatiche modello delicato	71
PEAN Pinze vascolari atraumatiche	87
PEERS BERTRAM pinze fissateli	145
Periostotomi	204-209
Pinza per aorta	99, 101, 121-122
Pinza per applicare e rimuovere clamps	63
Pinza per iliaca	100, 132
Pinza per legature	65
Pinze aortiche	99, 115
Pinze atraumatiche	43-48
Pinze atraumatiche per diversi usi	96, 98, 106, 109, 115, 131, 136, 138-139
Pinze Bulldog	57-64
Pinze Bulldog	127-128
Pinze Bulldog atraumatiche	57-62
Pinze bulldog atraumatiche titanio	62
Pinze carotis	123, 138-139
Pinze emostatiche	65-75, 81-84
Pinze emostatiche titanio	66-67
Pinze fissateli	145-146
Pinze pediatriche	130, 133, 136, 140-144
Pinze per afferrare intestini e tessuti	154-156
Pinze per anastomosi	93-94, 118, 121, 123, 133-137
Pinze per aneurisma di aorta	102-105, 106-108
Pinze per bronchi	90
Pinze per coartazione	91-92, 117, 118-120, 131-132
Pinze per dissezione	38-42
Pinze per dissezione e per legature	116, 125-126, 150
Pinze per dissezione e per legature (Passafili)	76-80
Pinze per legature	123
Pinze per medicatura	147-149
Pinze per microchirurgia	43
Pinze per occlusione tangenziale	110, 112
Pinze - per occlusioni temporari	52-55
Pinze per peritoneo	85
Pinze per profonda	126
Pinze per ritorcere fili	212
Pinze serretubi	86
Pinze sgorbie	192-196
Pinze taglienti per aorta	16



Pinze vascolari atraumatiche	.87-144
Pinze vascolari periferali	.95, 97, 114, 124
Pinze ventricolari	.113
POPPE Tubi d'aspirazione	.5
Port'aghi	.184-189
Porta-legature	.256
POTTS pinze per coartazione	.91-92, 117
POTTS-SMITH Forbici vascolari	.29-31
POTTS-SMITH Pinze per dissezione	.38
PRESBYTERIAN HOSPITAL pinze serretubi	.86
PRICE-THOMAS Pinze per bronchi	.152
PROVIDENCE-HOSPITAL pinze emostatiche	.68
Punta per aspirazione	.3

**R**

RANKIN Pinze vascolari atraumatiche	.88
REILL tenaglie tagliafilati laterali, tenaglie tagliafilati	.214
REYNOLDS Forbici	.27
RIBBON spatole addominali	.158
ROBB dissestori vascolari	.258
ROCHESTER-CARMALT pinze emostatiche	.73
ROCHESTER-OCHSNER pinze emostatiche	.70
ROCHESTER-PEAN pinze emostatiche	.69
RUMEL-BELMONT tornichetti	.256
RUMMEL pinze emostatiche	.81
RUSKIN LISTON cesoie per ossa	.198
RUSKIN pinze sgorbie	.192
Russ. Mod. Pinze per dissezione	.42
RYDER port'aghi	.186

**S**

SANTULLI pinze bulldog atraumatiche	.57
SANVENERO Forbici	.26
SAROT pinze emostatiche	.81
SAROT port'aghi	.188
SATINSKY Forbici	.34
SATINSKY pinze per anastomosi (vena cava)	.153
SATINSKY pinze per occlusione tangenziale	.110
SAUERBRUCH divaricatori	.171
SAUERBRUCH pinze sgorbie	.194
SAUERBUCH costotomi	.219
SAUERBUCH-FREY costotomi	.220
SCHAEDEL pinze fissateli	.145
SCHEIBE pinze per afferrare intestini e tessuti	.156
SCHMID Aghi vascolari per irrigazione	.5
SCHNIDT pinze per dissezione e per legature	.150
SCHUMACHER forbici per sterno	.215
SELLORS approssimatori costali	.177
SEMB cesoie per ossa	.201
SEMB periostotomi	.208
SEMB Pinze per bronchi	.153
SEMB pinze sgorbie	.196
SEMB tenaglie per ossa	.203
SEMKEN Pinze per dissezione	.41
SIMON divaricatori	.169
SINGLY Pinze per dissezione	.42
Sola	.50
Sonde per vein	.248-249
Spatola per intima	.258
Spatole addominali	.158
Spatole per pulmone	.178

SPENCER-WELLS pinze emostatiche	.73
STANDARD Applicatore per pinze	.56
STANDARD pinze - per occlusioni temporari	.55
STILLE costotomi	.216
STILLE HORSLEY cesoie per ossa	.201
STILLE LISTON cesoie per ossa	.199-200
STILLE LUER pinze sgorbie	.193-194
STRUCK divaricatori costali	.237
SUBRAMANIAN-MINIATURE pinza per aorta	.121
SUBRAMANIAN pinza per aorta	.121

**T**

Tenaglie per ossa	.202-203
Tenaglie piatte	.210-211
Tenaglie tagliafilati laterali, Tenaglie tagliafilati	.213
Titanio pinze atraumatiche	.44
Titanio pinze per microchirurgia	.43
TOENNIS-ADSON Forbici	.34
TOENNIS dissestori per la dura-madre	.253
TOHOKU pinze fissateli	.146
TUBBS dilatatori per valvole mitrali	.255
Tubi d'aspirazione	.2-6
TUFFIER divaricatori costali	.240

**U**

ULRICH pinze per medicatura	.147
-----------------------------	------

**V**

VARADY sonde per vein	.249
VARADY strumenti per varid	.251
VOLKMANN divaricatori	.163
VOLLMAR stripper anello	.250

**W**

WALTON YANKAUER Tubi d'aspirazione	.3
WANGENSTEEN Pinze per dissezione	.42
WANGENSTEEN port'aghi	.187
WAUGH Pinze per dissezione	.40
WEBER pinza per aorta	.101
WECKER spatola per iride	.254
WEINBERG divaricatori costali	.235
WEITLANER divaricatori autostatici	.172-175
WICKSTROEM pinze emostatiche	.84
WYLIE Pinze vascolari atraumatiche	.112

**Y**

YANKAUER Tubi d'aspirazione	.3
-----------------------------	----

**Z**

ZAUFAL JANSEN pinze sgorbie	.192
ZENKER divaricatori	.166
ZENKER pinze emostatiche	.82

*dimeda*<sup>®</sup>

SURGICAL INSTRUMENTS

Nummernverzeichnis  
Numerical Index  
Index Numérique  
Índice Numérico  
Indice Numerico

**04**

04.141.35	2
04.143.31	2
04.145.30	2
04.147.33	2
04.150.27	3
04.150.98	3
04.150.99	3
04.152.33	3
04.154.16	4
04.154.26	4
04.154.27	4
04.158.00	4

**06**

06.103.00	8
06.103.02	8
06.103.03	9
06.103.06	8
06.103.33	9
06.104.00	10
06.104.02	10
06.104.06	10
06.107.00	9
06.107.01	9
06.110.00	11
06.111.00	11
06.112.00	11
06.112.02	11
06.115.00	11
06.115.01	11
06.118.00	11
06.119.00	11
06.120.00	11
06.121.00	11
06.122.00	11
06.123.00	11
06.124.00	11
06.125.00	11
06.136.00	11
06.199.00	12
06.210.00	14
06.211.00	14
06.212.00	14
06.212.02	14
06.213.00	14
06.215.00	14
06.215.01	14
06.218.00	15
06.219.00	15
06.220.00	15
06.221.00	15
06.222.00	15
06.223.00	15
06.224.00	15
06.302.13	13

**07**

07.102.10	18
07.102.11	18
07.102.13	18
07.102.14	18
07.102.15	18
07.102.16	18
07.102.18	18
07.102.20	18
07.103.10	18
07.103.11	18
07.103.13	18
07.103.14	18
07.103.15	18
07.103.16	18
07.103.18	18
07.103.20	18
07.104.14	18
07.104.16	18
07.105.14	18
07.105.16	18
07.110.11	19
07.110.13	19
07.110.14	19
07.110.15	19
07.110.16	19
07.110.18	19
07.110.20	19
07.111.11	19
07.111.13	19
07.111.14	19
07.111.15	19
07.111.16	19
07.111.18	19
07.111.20	19
07.114.14	19
07.114.16	19
07.115.14	19
07.115.16	19
07.120.10	20
07.120.11	20
07.120.13	20
07.120.14	20
07.120.15	20
07.120.16	20
07.120.18	20
07.120.20	20
07.121.10	20
07.121.11	20
07.121.13	20
07.121.14	20
07.121.15	20
07.121.16	20
07.121.18	20
07.121.20	20
07.124.14	20
07.124.16	20
07.125.14	20
07.125.16	20
07.160.14	21
07.160.17	21

07.160.23	21
07.161.14	21
07.161.17	21
07.161.23	21
07.164.14	21
07.164.17	21
07.164.23	21
07.165.14	21
07.165.17	21
07.165.23	21
07.190.16	23
07.190.21	23
07.191.16	23
07.191.21	23
07.194.16	23
07.194.21	23
07.195.16	23
07.195.21	23
07.280.11	24
07.280.15	24
07.280.18	24
07.280.20	24
07.280.23	24
07.280.25	24
07.280.28	24
07.280.30	24
07.281.11	24
07.281.15	24
07.281.18	24
07.281.20	24
07.281.23	24
07.281.25	24
07.281.28	24
07.281.30	24
07.284.11	24
07.284.15	24
07.284.18	24
07.284.20	24
07.284.23	24
07.284.25	24
07.284.28	24
07.284.30	24
07.285.11	24
07.285.15	24
07.285.18	24
07.285.20	24
07.285.23	24
07.285.25	24
07.285.28	24
07.285.30	24
07.480.25	30
07.480.40	30
07.480.60	30
07.484.25	30
07.484.40	30
07.484.60	30

**08**

08.102.10	18
08.102.11	18
08.102.13	18

08.102.14	18
08.102.15	18
08.102.16	18
08.102.18	18
08.102.20	18
08.103.10	18
08.103.11	18
08.103.13	18
08.103.14	18
08.103.15	18
08.103.16	18
08.103.18	18
08.103.20	18
08.104.14	18
08.104.16	18
08.104.18	18
08.105.14	18
08.105.16	18
08.105.18	18
08.110.10	19
08.110.11	19
08.110.13	19
08.110.14	19
08.110.15	19
08.110.16	19
08.110.18	19
08.110.20	19
08.111.10	19
08.111.11	19
08.111.13	19
08.111.14	19
08.111.15	19
08.111.16	19
08.111.18	19
08.111.20	19
08.114.14	19
08.114.16	19
08.114.18	19
08.115.14	19
08.115.16	19
08.115.18	19
08.120.10	20
08.120.11	20
08.120.13	20
08.120.14	20
08.120.15	20
08.120.16	20
08.120.18	20
08.120.20	20
08.121.10	20
08.121.11	20
08.121.13	20
08.121.14	20
08.121.15	20
08.121.16	20
08.121.18	20
08.121.20	20
08.124.14	20
08.124.16	20
08.124.18	20
08.125.14	20

08.125.16	20
08.125.18	20
08.160.14	21
08.160.17	21
08.160.19	21
08.160.23	21
08.160.28	21
08.161.14	21
08.161.17	21
08.161.19	21
08.161.23	21
08.161.28	21
08.164.14	21
08.164.17	21
08.164.23	21
08.165.14	21
08.165.17	21
08.165.23	21
08.170.15	22
08.170.17	22
08.171.15	22
08.171.17	22
08.174.15	22
08.174.17	22
08.175.15	22
08.175.17	22
08.190.16	23
08.190.21	23
08.191.16	23
08.191.21	23
08.194.16	23
08.194.21	23
08.195.16	23
08.195.21	23
08.196.16	22
08.197.16	22
08.280.15	24
08.280.18	24
08.280.20	24
08.280.23	24
08.280.25	24
08.280.28	24
08.280.30	24
08.281.15	24
08.281.18	24
08.281.20	24
08.281.23	24
08.281.25	24
08.281.28	24
08.281.30	24
08.282.15	25
08.282.18	25
08.282.20	25
08.282.23	25
08.282.25	25
08.282.28	25
08.283.15	25
08.283.18	25
08.283.20	25
08.283.23	25
08.283.25	25



08.283.28	25	08.480.60	29	10.102.16	38	10.256.20	42	10.589.18	43
08.284.15	24	08.480.61	29	10.102.18	38	10.256.25	42	10.589.21	43
08.284.18	24	08.484.25	29	10.102.20	38	10.257.15	42		
08.284.20	24	08.484.40	29	10.102.25	38	10.258.15	42	<b>11</b>	
08.284.23	24	08.484.60	29	10.102.30	38	10.260.12	41	11.290.15	44
08.284.25	24	08.486.25	31	10.110.11	38	10.260.15	41	11.290.20	44
08.284.28	24	08.486.45	31	10.110.13	38	10.262.15	40	11.290.24	44
08.284.30	24	08.486.60	31	10.110.14	38	10.262.20	40	11.292.15	44
08.285.15	24	08.486.90	31	10.110.16	38	10.270.12	41	11.292.20	44
08.285.18	24	08.487.25	31	10.110.18	38	10.270.15	41	11.292.24	44
08.285.20	24	08.488.25	31	10.110.20	38	10.272.15	41	11.298.15	44
08.285.23	24	08.490.16	32	10.110.25	38	10.272.16	41	11.298.20	44
08.285.25	24	08.490.23	32	10.110.30	38	10.302.18	41	11.298.24	44
08.285.28	24	08.490.28	32	10.112.18	38	10.304.17	41	11.300.16	44
08.285.30	24	08.491.16	32	10.112.21	38	10.306.17	41	11.300.20	44
08.286.15	25	08.491.23	32	10.112.25	38	10.310.18	41	11.300.24	44
08.286.18	25	08.491.28	32	10.112.30	38	10.310.23	41	11.302.16	44
08.286.20	25	08.492.16	32	10.114.14	38	10.316.14	42	11.302.20	44
08.286.23	25	08.492.23	32	10.114.16	38	10.316.16	42	11.302.24	44
08.286.25	25	08.492.28	32	10.116.18	38	10.316.20	42	11.304.16	45
08.286.28	25	08.493.23	32	10.116.21	38	10.320.18	42	11.304.20	45
08.287.15	25	08.493.28	32	10.116.25	38	10.320.23	42	11.304.24	45
08.287.18	25	08.495.15	33	10.120.11	38	10.322.15	42	11.304.30	45
08.287.20	25	08.497.15	33	10.120.13	38	10.322.18	42	11.306.16	45
08.287.23	25	08.500.14	33	10.120.14	38	10.322.23	42	11.306.20	45
08.287.25	25	08.560.20	34	10.120.16	38	10.326.15	42	11.306.24	45
08.287.28	25	08.582.15	34	10.120.18	38	10.326.23	42	11.306.30	45
08.288.18	26	08.583.15	34	10.120.20	38	10.326.25	42	11.308.16	45
08.288.20	26	08.613.17	34	10.120.25	38	10.564.15	43	11.308.20	45
08.291.18	26	08.651.24	34	10.120.30	38	10.564.18	43	11.308.24	45
08.295.18	26	08.831.12	213	10.126.18	38	10.565.15	43	11.308.30	45
08.302.14	26	08.835.12	213	10.126.21	38	10.565.18	43	11.309.16	46
08.303.14	26	08.838.12	213	10.126.25	38	10.566.15	43	11.309.20	46
08.304.14	26			10.130.11	38	10.566.18	43	11.309.24	46
08.305.14	26	<b>09</b>		10.130.13	38	10.566.21	43	11.309.30	46
08.310.12	27	09.224.25	35	10.130.14	38	10.566.23	43	11.310.16	45
08.310.15	27	09.224.45	35	10.130.16	38	10.567.15	43	11.310.20	45
08.314.12	27	09.224.60	35	10.130.18	38	10.567.18	43	11.310.24	45
08.314.15	27	09.224.90	35	10.130.20	38	10.567.21	43	11.310.30	45
08.320.15	27	09.225.00	35	10.130.25	38	10.567.23	43	11.314.16	46
08.321.15	27	09.710.15	35	10.130.30	38	10.568.15	43	11.314.20	46
08.321.18	27	09.710.18	35	10.131.13	38	10.568.18	43	11.314.24	46
08.324.15	27	09.710.21	35	10.131.14	38	10.569.15	43	11.315.15	46
08.325.15	27	09.710.23	35	10.170.12	39	10.569.18	43	11.315.19	46
08.340.09	28	09.711.15	35	10.170.15	39	10.570.15	43	11.315.24	46
08.340.10	28	09.711.18	35	10.174.12	39	10.570.18	43	11.316.16	46
08.340.11	28	09.711.21	35	10.174.15	39	10.570.21	43	11.316.20	46
08.340.12	28	09.711.23	35	10.176.12	39	10.570.23	43	11.316.24	46
08.341.09	28	09.712.15	35	10.176.15	39	10.571.15	43	11.318.12	47
08.341.10	28	09.712.18	35	10.180.12	39	10.571.18	43	11.318.15	47
08.341.11	28	09.712.21	35	10.180.15	39	10.571.21	43	11.322.16	45
08.341.12	28	09.712.23	35	10.184.12	39	10.571.23	43	11.322.20	45
08.344.11	28	09.713.15	35	10.184.15	39	10.574.15	43	11.322.24	45
08.345.11	28	09.713.18	35	10.186.12	39	10.574.18	43	11.322.30	45
08.351.11	28	09.713.21	35	10.186.15	39	10.574.21	43	11.324.15	45
08.353.11	28	09.713.23	35	10.220.17	40	10.574.23	43	11.324.20	45
08.354.11	28			10.224.17	40	10.576.15	43	11.324.24	45
08.470.11	28	<b>10</b>		10.225.17	40	10.576.18	43	11.324.30	45
08.480.18	31	10.102.11	38	10.226.18	40	10.576.21	43	11.332.15	45
08.480.25	29	10.102.13	38	10.230.17	40	10.576.23	43	11.332.20	45
08.480.40	29	10.102.14	38	10.256.15	42	10.589.15	43	11.332.24	45

11.332.30	45	11.586.18	43	12.078.14	58	12.132.40	62	12.250.14	67
11.333.15	46	11.586.21	43	12.078.20	58	12.132.50	62	12.251.14	67
11.333.20	46	11.588.15	43	12.079.10	58	12.133.30	62	12.254.14	67
11.333.24	46	11.588.18	43	12.079.14	58	12.133.35	62	12.255.14	67
11.333.30	46	11.588.21	43	12.079.20	58	12.133.40	62	12.260.14	67
11.334.15	45	11.590.15	43	12.082.08	58	12.133.50	62	12.261.14	67
11.334.20	45	11.590.18	43	12.082.12	58	12.135.30	62	12.262.16	68
11.334.24	45	11.590.21	43	12.082.16	58	12.135.35	62	12.263.16	68
11.334.30	45			12.083.08	58	12.135.40	62	12.264.16	68
11.402.15	48	<b>12</b>		12.083.12	58	12.135.50	62	12.265.16	68
11.402.20	48	12.010.00	49	12.083.16	58	12.142.30	62	12.270.14	68
11.402.24	48	12.011.00	49	12.084.08	61	12.142.35	62	12.271.14	68
11.404.15	48	12.012.00	49	12.084.09	61	12.142.40	62	12.284.14	78
11.404.19	48	12.013.00	49	12.084.10	61	12.142.50	62	12.310.14	69
11.404.24	48	12.014.00	49	12.084.12	61	12.143.30	62	12.310.16	69
11.412.15	48	12.016.00	50	12.085.08	61	12.143.35	62	12.310.18	69
11.412.19	48	12.024.00	50	12.085.09	61	12.143.40	62	12.310.20	69
11.412.24	48	12.028.01	51	12.085.10	61	12.143.50	62	12.310.22	69
11.414.15	48	12.028.02	51	12.085.12	61	12.145.30	62	12.310.24	69
11.414.19	48	12.028.03	51	12.087.09	57	12.145.35	62	12.310.26	69
11.414.24	48	12.028.04	51	12.087.11	57	12.145.40	62	12.310.30	69
11.416.15	48	12.030.50	52	12.089.07	57	12.145.50	62	12.311.14	69
11.416.19	48	12.030.80	52	12.091.23	63	12.210.10	65	12.311.16	69
11.416.24	48	12.031.50	52	12.092.07	59	12.211.10	65	12.311.18	69
11.422.15	48	12.031.80	52	12.092.08	59	12.212.10	65	12.311.20	69
11.422.19	48	12.033.50	52	12.092.10	59	12.213.10	65	12.311.22	69
11.422.24	48	12.033.80	52	12.092.12	59	12.215.12	65	12.311.24	69
11.424.15	48	12.035.50	52	12.093.07	59	12.220.12	66	12.311.26	69
11.424.19	48	12.035.80	52	12.093.08	59	12.220.14	66	12.311.30	69
11.424.24	48	12.037.50	52	12.093.10	59	12.220.18	66	12.312.13	71
11.426.15	48	12.037.80	52	12.093.12	59	12.220.21	66	12.312.14	71
11.426.19	48	12.040.01	53	12.096.06	60	12.221.12	66	12.312.16	71
11.426.24	48	12.040.02	53	12.096.07	60	12.221.14	66	12.313.13	71
11.430.15	47	12.040.03	53	12.096.09	60	12.221.18	66	12.313.14	71
11.430.18	47	12.041.00	50	12.096.11	60	12.221.21	66	12.313.16	71
11.452.15	47	12.041.01	50	12.097.06	60	12.222.10	66	12.316.14	72
11.456.20	47	12.041.02	50	12.097.07	60	12.222.12	66	12.316.16	72
11.456.24	47	12.043.01	54	12.097.09	60	12.223.10	66	12.316.18	72
11.462.15	47	12.043.02	54	12.097.11	60	12.223.12	66	12.317.14	72
11.462.24	47	12.043.03	54	12.102.04	63	12.224.12	66	12.317.16	72
11.578.15	43	12.043.04	54	12.102.05	63	12.225.12	66	12.317.18	72
11.578.18	43	12.044.14	50	12.103.04	63	12.230.12	66	12.320.14	70
11.579.15	43	12.046.14	49	12.103.05	63	12.230.14	66	12.320.16	70
11.579.18	43	12.046.14	51	12.104.06	63	12.230.18	66	12.320.18	70
11.580.15	43	12.046.14	53	12.105.06	63	12.230.21	66	12.320.20	70
11.580.18	43	12.048.14	49	12.110.50	63	12.231.12	66	12.320.22	70
11.580.21	43	12.048.14	51	12.110.55	63	12.231.14	66	12.320.24	70
11.581.15	43	12.048.14	53	12.110.65	63	12.231.18	66	12.320.26	70
11.581.18	43	12.050.14	50	12.110.70	63	12.231.21	66	12.320.30	70
11.581.21	43	12.050.15	54	12.110.75	63	12.232.10	66	12.321.14	70
11.582.15	43	12.059.07	57	12.110.90	63	12.232.12	66	12.321.16	70
11.582.18	43	12.061.09	57	12.111.50	63	12.233.10	66	12.321.18	70
11.583.15	43	12.063.10	57	12.111.55	63	12.233.12	66	12.321.20	70
11.583.18	43	12.065.06	57	12.111.65	63	12.234.12	66	12.321.22	70
11.584.15	43	12.070.35	63	12.111.70	63	12.235.12	66	12.321.24	70
11.584.18	43	12.070.45	63	12.111.75	63	12.240.14	67	12.321.26	70
11.584.21	43	12.070.50	57	12.111.90	63	12.241.14	67	12.321.30	70
11.585.15	43	12.071.35	63	12.112.20	64	12.242.16	67	12.322.13	71
11.585.18	43	12.071.45	63	12.112.30	64	12.243.16	67	12.322.14	71
11.585.21	43	12.071.50	57	12.132.30	62	12.244.14	67	12.322.16	71
11.586.15	43	12.078.10	58	12.132.35	62	12.245.14	67	12.323.13	71

12.323.14	71	12.428.01	79	12.710.15	86	13.174.30	96	13.267.24	113
12.323.16	71	12.428.06	79	12.710.18	86	13.174.45	96	13.269.24	113
12.326.14	72	12.428.10	79	12.710.20	86	13.174.90	96	13.270.25	114
12.326.16	72	12.428.11	79	12.712.15	86	13.181.19	97	13.270.26	114
12.326.18	72	12.428.12	79	12.712.18	86	13.181.26	97	13.271.18	114
12.327.14	72	12.428.13	79	12.712.18	86	13.183.19	97	13.273.17	114
12.327.16	72	12.428.16	79	12.712.20	86	13.183.20	97	13.273.18	114
12.327.18	72	12.429.01	80			13.191.16	97	13.273.19	114
12.330.13	73	12.429.02	80	<b>13</b>		13.196.15	98	13.281.17	115
12.330.14	73	12.429.03	80	13.080.12	87	13.196.18	98	13.283.17	115
12.330.15	73	12.429.04	80	13.080.15	87	13.197.15	98	13.284.20	115
12.330.18	73	12.429.05	80	13.081.12	87	13.197.18	98	13.284.21	115
12.330.20	73	12.431.13	77	13.081.15	87	13.202.19	98	13.285.24	116
12.331.13	73	12.431.16	77	13.082.14	87	13.203.19	98	13.287.24	116
12.331.14	73	12.431.18	77	13.082.16	87	13.205.19	98	13.288.21	117
12.331.15	73	12.431.20	77	13.082.18	87	13.209.27	99	13.288.23	117
12.331.18	73	12.431.23	77	13.082.20	87	13.211.20	99	13.288.27	117
12.331.20	73	12.431.25	77	13.083.14	87	13.213.20	99	13.288.31	117
12.340.16	73	12.431.28	77	13.083.16	87	13.215.20	100	13.289.21	117
12.340.20	73	12.433.18	77	13.083.18	87	13.217.26	101	13.289.23	117
12.341.16	73	12.433.22	77	13.083.20	87	13.219.26	101	13.289.27	117
12.341.20	73	12.433.25	77	13.084.16	88	13.221.24	102	13.289.31	117
12.354.15	74	12.433.28	77	13.085.16	88	13.221.27	102	13.291.16	118
12.356.15	74	12.441.01	81	13.101.40	88	13.221.31	102	13.291.17	118
12.380.15	74	12.441.02	81	13.101.50	88	13.221.33	102	13.291.18	118
12.381.15	74	12.441.03	81	13.101.60	88	13.221.35	102	13.302.16	119
12.382.15	74	12.441.04	81	13.102.12	89	13.223.24	103	13.302.17	119
12.383.15	74	12.450.24	81	13.103.12	89	13.223.25	103	13.303.15	119
12.384.20	75	12.451.24	81	13.111.12	89	13.223.26	103	13.305.15	118
12.384.26	75	12.453.18	81	13.113.12	89	13.225.28	104	13.307.17	119
12.385.20	75	12.453.24	81	13.121.12	89	13.227.28	104	13.309.16	118
12.385.26	75	12.455.01	82	13.131.23	90	13.229.18	105	13.309.17	118
12.386.20	75	12.455.02	82	13.131.25	90	13.229.18	105	13.311.14	120
12.386.26	75	12.457.28	82	13.133.25	90	13.229.20	105	13.311.15	120
12.387.20	75	12.468.14	82	13.140.20	91	13.229.23	105	13.311.16	120
12.387.26	75	12.469.14	82	13.140.21	91	13.229.25	105	13.311.16	120
12.390.20	75	12.471.14	83	13.140.22	91	13.231.18	106	13.321.17	120
12.391.20	75	12.471.16	83	13.140.26	91	13.231.21	106	13.323.17	120
12.393.20	75	12.471.18	83	13.141.20	91	13.231.23	106	13.329.01	121
12.396.19	76	12.471.23	83	13.141.22	91	13.231.27	106	13.329.02	121
12.410.18	76	12.471.22	83	13.141.26	91	13.241.25	107	13.329.03	121
12.411.18	76	12.473.23	83	13.142.21	92	13.241.26	107	13.329.04	121
12.412.18	76	12.475.14	83	13.142.22	92	13.247.27	108	13.331.15	121
12.413.18	76	12.475.18	83	13.143.21	92	13.251.20	109	13.333.16	121
12.415.14	76	12.476.21	80	13.143.22	92	13.251.24	109	13.335.16	121
12.415.18	76	12.477.15	84	13.151.21	93	13.251.25	109	13.337.23	122
12.421.01	78	12.477.19	84	13.151.24	93	13.251.30	109	13.337.26	122
12.421.02	78	12.478.21	84	13.153.18	93	13.253.20	110	13.339.21	122
12.421.03	78	12.478.24	84	13.153.22	93	13.253.24	110	13.341.19	123
12.421.04	78	12.479.22	84	13.161.21	94	13.253.25	110	13.341.20	123
12.421.05	78	12.479.25	84	13.161.26	94	13.253.26	110	13.341.23	123
12.421.06	78	12.479.28	84	13.170.19	95	13.253.27	110	13.343.18	123
12.421.07	78	12.489.22	84	13.170.22	95	13.258.00	111	13.343.19	123
12.427.01	78	12.550.14	85	13.171.19	95	13.258.06	111	13.344.16	124
12.427.02	78	12.550.20	85	13.171.22	95	13.258.12	111	13.344.17	124
12.427.03	78	12.550.21	85	13.172.00	96	13.259.01	112	13.344.18	124
12.427.04	78	12.553.18	85	13.172.15	96	13.259.02	112	13.344.20	124
12.427.05	78	12.553.20	85	13.172.30	96	13.261.23	112	13.345.01	125
12.427.06	78	12.702.14	86	13.172.45	96	13.261.24	112	13.345.02	125
12.427.07	78	12.704.16	86	13.172.90	96	13.261.25	112	13.345.21	126
12.428.00	79	12.704.18	86	13.174.00	96	13.263.25	113	13.345.28	125
				13.174.15	96	13.265.24	113	13.349.14	126

13.349.16	126	13.465.19	138	16.111.14	147	18.187.75	160	18.490.22	170
13.349.18	126	13.465.26	139	16.111.18	147	18.189.25	160	18.490.43	170
13.350.13	127	13.467.27	139	16.111.20	147	18.189.38	160	18.490.65	170
13.351.13	127	13.481.13	140	16.111.22	147	18.189.50	160	18.492.25	171
13.353.13	127	13.483.13	140	16.111.25	147	18.189.75	160	18.496.90	171
13.355.13	128	13.485.13	140	16.111.27	147	18.191.40	161	18.620.07	172
13.357.12	128	13.487.13	140	16.111.36	147	18.191.62	161	18.620.10	172
13.359.10	127	13.489.13	140	16.111.40	147	18.191.64	161	18.621.07	172
13.361.12	128	13.491.15	140	16.160.22	147	18.224.01	252	18.621.10	172
13.363.13	128	13.493.15	140	16.160.25	147	18.224.02	252	18.624.10	172
13.371.24	129	13.495.12	140	16.160.27	147	18.230.08	162	18.650.10	172
13.371.26	129	13.495.15	140	16.161.22	147	18.230.10	162	18.651.10	172
13.371.28	129	13.505.01	141	16.161.25	147	18.230.12	162	18.660.16	173
13.373.30	129	13.505.02	141	16.161.27	147	18.230.14	162	18.661.16	173
13.373.32	129	13.505.03	141	16.170.18	148	18.230.16	162	18.661.17	173
13.373.36	129	13.505.04	141	16.170.20	148	18.230.18	162	18.661.18	173
13.376.14	130	13.505.05	141	16.170.25	148	18.232.08	162	18.661.19	173
13.376.16	131	13.505.06	141	16.170.30	148	18.232.10	162	18.670.14	173
13.377.14	130	13.505.07	141	16.171.18	148	18.232.12	162	18.670.16	173
13.377.16	131	13.505.08	141	16.171.20	148	18.232.14	162	18.670.20	175
13.379.14	130	13.505.09	141	16.171.25	148	18.232.16	162	18.670.25	174
13.380.14	130	13.508.16	142	16.171.30	148	18.232.18	162	18.670.26	174
13.381.14	130	13.509.16	142	16.172.18	148	18.234.00	162	18.671.14	173
13.405.27	131	13.510.16	142	16.172.20	148	18.234.01	162	18.671.16	173
13.410.17	132	13.511.15	142	16.172.25	148	18.234.02	162	18.671.20	175
13.411.17	132	13.512.16	142	16.172.30	148	18.282.01	163	18.671.25	174
13.413.17	132	13.513.30	143	16.173.18	148	18.283.01	163	18.671.26	174
13.416.17	132	13.513.45	143	16.173.20	148	18.283.03	163	18.684.16	175
13.417.21	132	13.515.48	144	16.173.25	148	18.312.01	163	18.686.32	176
13.417.25	132	13.515.50	144	16.173.30	148	18.312.02	163	18.690.31	176
13.419.17	133	13.515.52	144	16.210.13	149	18.312.03	163		
13.420.14	133	13.515.56	144	16.210.16	149	18.312.04	163		
13.421.14	133			16.210.18	149	18.312.05	163	<b>20</b>	
13.423.14	133	<b>14</b>		16.244.17	149	18.312.05	163	20.150.00	248
13.425.14	133	14.101.09	145	16.245.17	149	18.315.21	164	20.150.02	248
13.426.15	134	14.103.05	145			18.315.22	164	20.150.03	248
13.426.16	134	14.103.09	145	<b>18</b>		18.318.82	164	20.150.06	248
13.427.14	134	14.105.09	145	18.170.25	158	18.318.83	164	20.150.09	248
13.427.15	134	14.111.09	145	18.170.32	158	18.332.19	164	20.150.12	248
13.427.16	134	14.111.11	145	18.170.40	158	18.332.21	164	20.150.15	248
13.430.31	135	14.111.13	145	18.170.50	158	18.341.18	164	20.150.80	248
13.430.44	135	14.111.15	145	18.171.20	158	18.342.01	165	20.150.90	248
13.430.50	135	14.118.14	145	18.171.30	158	18.342.02	165	20.150.99	248
13.430.63	135	14.123.09	146	18.171.40	158	18.342.03	165	20.151.00	249
13.430.78	135	14.123.10	146	18.173.06	158	18.342.04	165	20.151.03	249
13.431.25	136	14.123.11	146	18.173.09	158	18.342.05	165	20.151.04	249
13.431.45	136	14.123.13	146	18.173.09	158	18.342.06	165	20.151.05	249
13.431.90	136	14.123.13	146	18.173.13	158	18.342.07	165	20.151.90	249
13.433.14	136	14.123.14	146	18.173.16	158	18.342.08	165	20.151.99	249
13.441.16	136	14.123.16	146	18.173.19	158	18.342.09	165	20.160.02	250
13.441.17	136	14.127.10	146	18.173.25	158	18.343.12	166	20.160.03	250
13.441.18	136	14.127.13	146	18.174.17	158	18.343.35	166	20.160.04	250
13.447.17	137			18.174.25	158	18.343.60	166	20.160.06	250
13.449.17	137	<b>16</b>		18.174.37	158	18.343.75	166	20.160.07	250
13.451.16	137	16.110.14	147	18.180.19	159	18.380.50	167	20.160.08	250
13.452.16	137	16.110.18	147	18.181.22	159	18.381.50	167	20.160.10	250
13.453.16	137	16.110.20	147	18.181.25	159	18.381.80	167	20.160.12	250
13.455.17	137	16.110.22	147	18.183.25	159	18.385.38	168	20.160.14	250
13.457.17	138	16.110.25	147	18.185.25	159	18.385.57	168	20.162.12	250
13.461.17	138	16.110.27	147	18.187.25	159	18.398.25	169	20.167.01	251
13.465.18	138	16.110.36	147	18.187.38	160	18.480.22	169	20.167.02	251
		16.110.40	147	18.187.50	160	18.480.27	169	20.167.03	251



20.167.04	251	32.205.18	192	32.725.17	206	40.065.02	252	40.859.10	13
20.167.05	251	32.215.20	192	32.727.17	206	40.065.03	252	40.868.23	253
20.167.06	251	32.218.23	192	32.729.01	208	40.065.04	252		
		32.219.23	192	32.729.02	208	40.139.16	252	<b>42</b>	
<b>22</b>		32.228.23	193	32.729.03	208	40.141.25	253	42.461.13	254
22.220.03	5	32.228.27	193	32.729.04	208	40.142.25	253	42.462.13	254
22.220.04	5	32.229.23	193	32.729.05	208	40.151.24	253		
22.220.05	5	32.229.27	193	32.753.20	205	40.191.01	253	<b>46</b>	
22.220.06	5	32.230.22	193	32.774.14	209	40.191.02	253	46.415.18	254
		32.231.22	193	32.775.14	209	40.275.06	5	46.560.18	254
<b>24</b>		32.235.23	194	32.779.06	209	40.275.08	5	46.562.18	254
24.144.13	184	32.241.30	194	32.781.06	209	40.275.10	5		
24.164.15	184	32.243.30	194	32.783.03	209	40.275.12	5	<b>50</b>	
24.168.15	184	32.245.23	195			40.290.21	5	50.181.19	150
24.184.16	185	32.247.23	195	<b>33</b>		40.295.06	6	50.183.19	150
24.184.18	185	32.255.24	195	33.530.02	210	40.295.07	6		
24.184.20	185	32.259.02	196	33.530.03	210	40.295.08	6	<b>56</b>	
24.184.30	185	32.259.03	196	33.530.04	210	40.295.09	6	56.102.23	215
24.214.15	185	32.259.23	196	33.530.05	210	40.295.10	6	56.105.22	215
24.214.18	185	32.261.22	196	33.530.06	210	40.295.11	6	56.107.22	216
24.214.23	185	32.270.17	196	33.530.07	210	40.295.12	6	56.111.21	216
24.214.26	185	32.274.14	197	33.530.08	210	40.295.15	6	56.123.35	217
24.214.31	185	32.274.17	197	33.530.09	210	40.297.06	6	56.125.35	217
24.216.18	186	32.274.19	197	33.530.10	210	40.297.07	6	56.126.34	218
24.216.21	186	32.274.22	197	33.530.11	210	40.297.08	6	56.128.35	218
24.216.23	186	32.275.14	197	33.530.12	210	40.297.09	6	56.131.26	219
24.216.31	186	32.275.17	197	33.530.15	210	40.297.10	6	56.137.27	219
24.224.13	186	32.275.19	197	33.532.01	210	40.297.11	6	56.141.36	220
24.224.18	186	32.275.22	197	33.532.02	210	40.297.12	6	56.147.28	220
24.224.20	186	32.280.15	197	33.532.03	210	40.297.15	6	56.148.21	215
24.224.26	186	32.281.15	197	33.533.01	210	40.567.10	55	56.149.28	220
24.226.13	186	32.284.17	198	33.533.02	210	40.567.12	55	56.210.16	222
24.226.15	186	32.286.18	198	33.533.03	210	40.567.20	55	56.210.20	222
24.226.18	186	32.289.18	198	33.537.01	210	40.567.22	55	56.210.25	222
24.226.20	186	32.290.26	199	33.537.02	210	40.567.40	55	56.210.30	222
24.226.21	186	32.290.27	199	33.537.03	210	40.567.46	55	56.212.12	222
24.245.21	187	32.291.23	200	33.537.04	210	40.567.50	55	56.214.75	223
24.245.26	187	32.291.27	200	33.538.01	211	40.567.52	55	56.220.01	223
24.264.27	187	32.293.27	201	33.538.02	211	40.567.54	55	56.220.02	223
24.276.14	187	32.295.24	201	33.538.19	211	40.772.17	56	56.220.03	224
24.276.18	187	32.295.24	201	33.538.19	211	40.772.18	56	56.220.04	224
24.276.20	187	32.360.21	202	33.545.16	213	40.772.21	56	56.220.05	225
24.276.23	187	32.362.21	202	33.545.22	213	40.772.23	56	56.220.06	225
24.315.27	188	32.364.19	203	33.546.18	214	40.772.24	56	56.220.07	223
24.324.18	188	32.365.19	203	33.547.17	214	40.772.31	56	56.220.08	224
24.324.26	188	32.386.20	203	33.547.23	214	40.772.31	56	56.220.09	224
24.374.14	188	32.678.24	204	33.552.17	212	40.774.17	56	56.220.10	224
24.374.17	188	32.702.15	204	33.568.14	211	40.774.19	56	56.220.60	226
24.374.20	188	32.703.15	204	33.569.14	211	40.774.21	56	56.220.61	226
24.394.14	188	32.705.05	204	33.599.20	212	40.774.22	56	56.220.62	226
24.394.17	188	32.705.10	204	33.600.15	212	40.774.23	56	56.220.63	226
24.394.20	188	32.705.15	204	33.600.20	212	40.774.24	56	56.220.64	226
24.486.20	189	32.705.20	204	33.601.15	212	40.776.18	56	56.230.13	227
24.674.14	189	32.705.25	204	33.601.19	212	40.776.20	56	56.230.16	227
24.678.14	189	32.711.18	205			40.778.18	56	56.230.17	227
24.678.18	189	32.715.16	205	<b>40</b>		40.778.20	56	56.230.18	227
24.678.21	189	32.715.20	205	40.054.20	252	40.859.01	13	56.232.10	228
		32.717.20	209	40.056.19	252	40.859.02	13	56.234.40	228
<b>32</b>		32.721.17	206	40.056.28	252	40.859.04	13	56.234.41	229
32.106.15	196	32.721.24	207	40.058.19	252	40.859.05	13	56.234.42	229
32.201.18	192	32.723.17	206	40.058.28	252	40.859.07	13		
		32.723.24	207	40.065.01	252	40.859.09	13		

56.234.43	229	56.270.00	243	56.472.10	257
56.234.44	229	56.270.10	243	56.472.15	257
56.234.75	229	56.270.48	243	56.472.20	257
56.236.21	230	56.270.70	243	56.472.25	257
56.236.25	230	56.272.15	244	56.472.30	257
56.236.30	230	56.272.20	244	56.472.35	257
56.238.00	231	56.273.15	245	56.472.40	257
56.238.01	231	56.273.16	245	56.472.45	257
56.238.02	231	56.273.19	245	56.472.50	257
56.238.03	231	56.273.20	245	56.472.70	257
56.238.04	231	56.273.30	245	56.472.90	257
56.238.05	231	56.278.00	246	56.505.18	258
56.238.06	231	56.280.19	177	56.505.21	258
56.242.18	232	56.282.14	177	56.507.14	258
56.242.26	232	56.284.16	177	56.507.24	258
56.242.30	232	56.286.16	177	56.509.01	258
56.242.98	232	56.288.30	178	56.509.02	258
56.242.99	232	56.289.26	178	56.509.03	258
56.244.13	233	56.289.28	178	56.509.04	258
56.244.98	233	56.289.30	178		
56.244.99	233	56.289.31	178	<b>62</b>	
56.245.01	234	56.289.32	178	62.106.20	153
56.245.02	234	56.290.20	151		
56.245.03	234	56.291.20	151	<b>64</b>	
56.245.04	234	56.293.01	179	64.110.15	154
56.245.05	234	56.293.02	179	64.110.19	154
56.250.06	235	56.293.03	179	64.110.25	154
56.250.07	235	56.293.04	180	64.120.15	154
56.250.12	235	56.293.05	180	64.120.19	154
56.251.01	235	56.295.01	181	64.120.22	154
56.256.00	236	56.295.02	181	64.120.24	154
56.256.01	236	56.295.03	181	64.120.30	154
56.256.11	236	56.295.04	181	64.124.16	154
56.256.12	236	56.295.05	181	64.124.20	154
56.256.13	236	56.295.06	181	64.124.25	154
56.258.00	237	56.307.24	150	64.124.30	154
56.258.01	237	56.309.22	152	64.160.16	155
56.258.11	237	56.311.22	152	64.160.18	155
56.258.12	237	56.313.22	152	64.160.20	155
56.258.13	237	56.321.23	153	64.160.24	155
56.258.14	237	56.323.23	153	64.164.16	155
56.258.15	237	56.325.15	153	64.164.20	155
56.260.09	238	56.380.04	16	64.168.16	155
56.260.15	238	56.380.05	16	64.168.20	155
56.262.12	239	56.418.42	255	64.174.20	156
56.262.16	239	56.420.15	255	64.178.18	156
56.264.14	240	56.430.32	256	64.178.20	156
56.264.16	240	56.430.64	256	64.178.23	156
56.266.00	241	56.431.15	256		
56.266.09	241	56.431.20	256	<b>74</b>	
56.266.30	241	56.431.25	256	74.103.15	258
56.266.40	241	56.431.30	256		
56.266.50	241	56.470.05	257	<b>87</b>	
56.266.66	241	56.470.10	257	87.574.15	214
56.268.00	242	56.470.15	257		
56.268.22	242	56.470.20	257		
56.268.40	242	56.470.25	257		
56.268.50	242	56.470.30	257		
56.268.60	242	56.470.40	257		
56.268.66	242	56.470.50	257		
56.268.80	242	56.472.05	257		





DIMEDA Instrumente GmbH  
Gänsäcker 54 - 58 · D-78532 Tuttlingen  
Tel +49 (0) 7462 9461-0 · Fax +49 (0) 7462 9461-33  
info@dimeda.de · www.dimeda.de