

44

Otologie
Otology
Otologie
Otología
Otologia

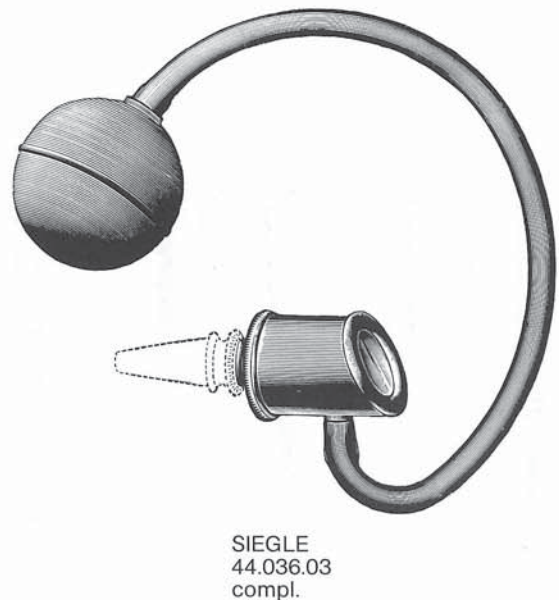

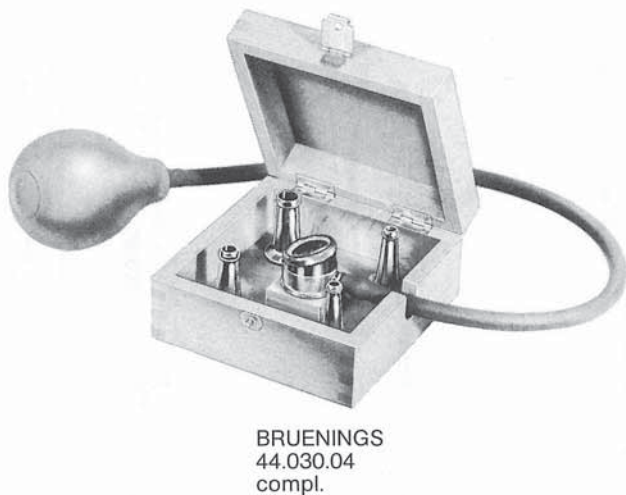
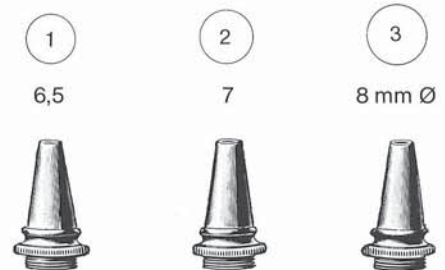
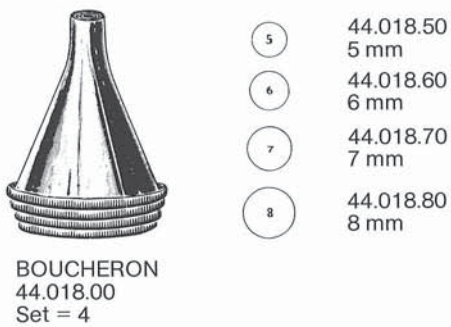
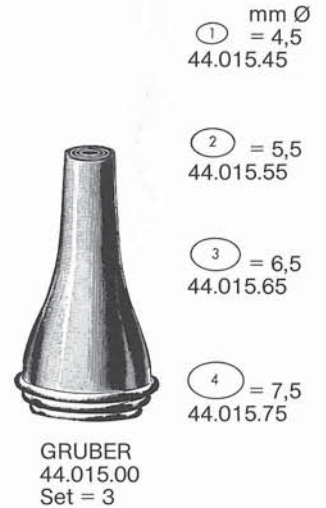
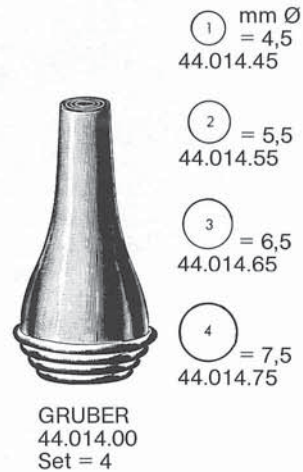
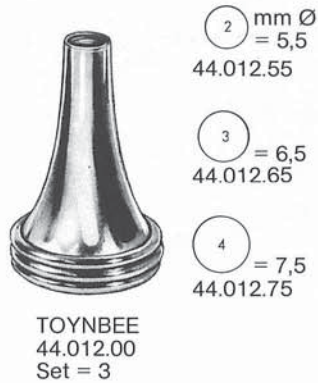
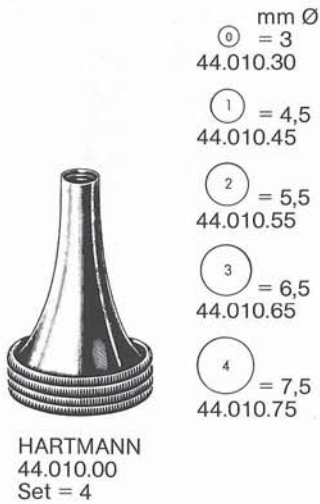

DIMEDA Alu

44.060.01
C 128

44.060.02
C¹ 256

44.060.03
C² 512

44.060.04
C³ 1024

44.060.05
C⁴ 2048



DIMEDA Alu
44.061.00
compl.

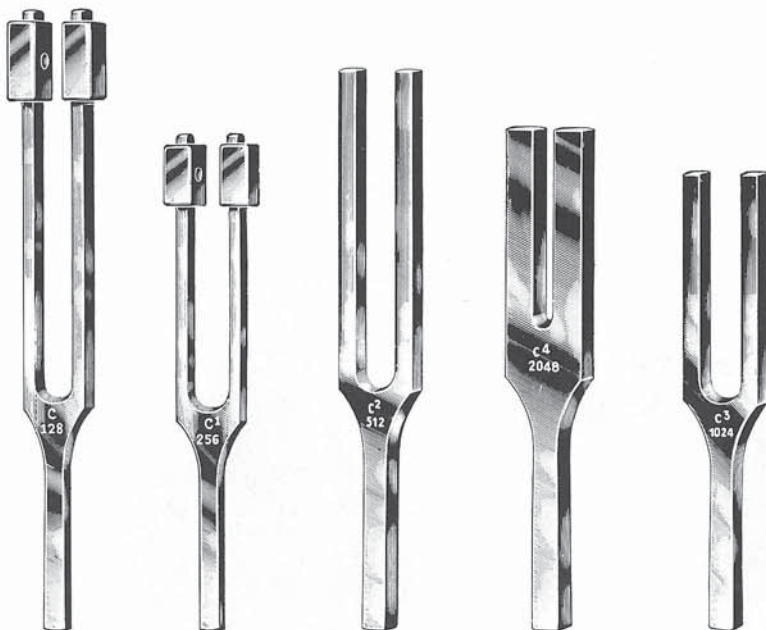

HARTMANN

44.070.01
C 128

44.070.02
C¹ 256

44.070.03
C² 512

44.070.04
C³ 1024

44.070.05
C⁴ 2048



HARTMANN
44.071.00
compl.

Stimmgabeln
Tuning Forks
Diapasons
Diapasones
Diapason

dimeda[®]

SURGICAL INSTRUMENTS



LUCAE
44.074.01
C 128

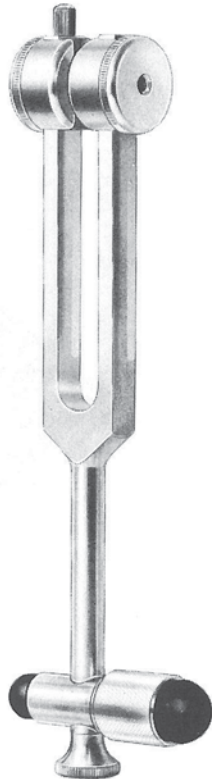

44.075.00
neurolog.

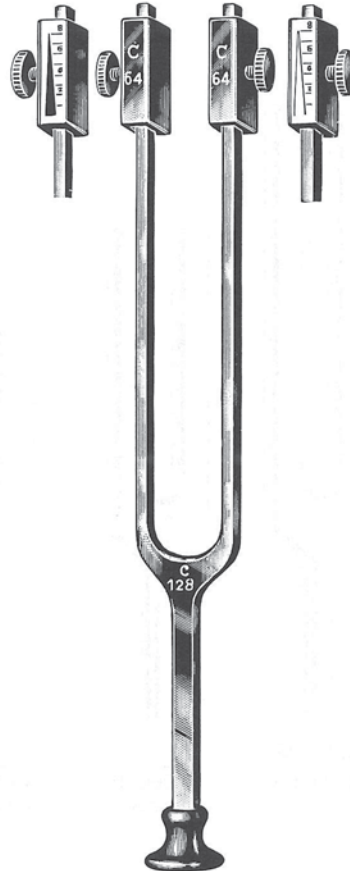

RYDEL-SEIFFER
44.076.01
C 64/c 128

Lärmapparat
Noise Apparatus
Assourdisseur
Ensordecedor
Assordatore

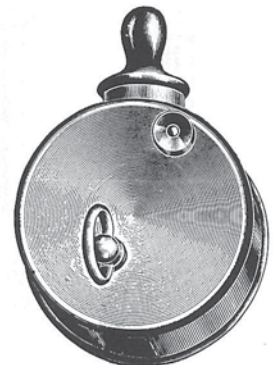

BARANY
44.080.00

Pulverbläser
Powder Blowers
Lance-Poudre
Lanzapolvero
Insuffiatori per polvere

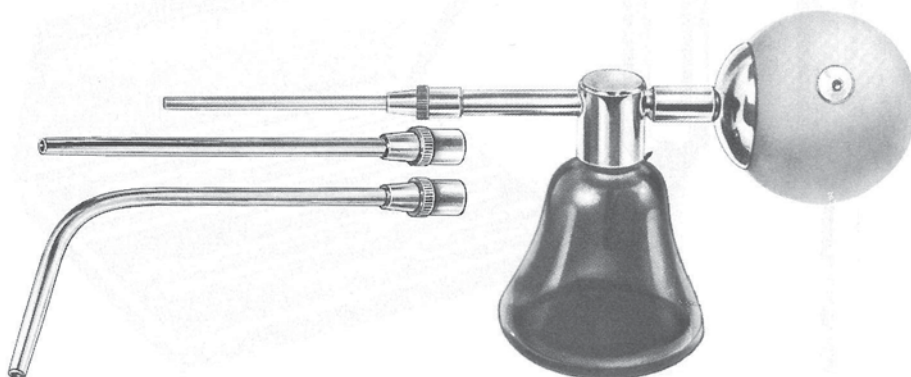

KABIERSKE
44.090.00
30 cc

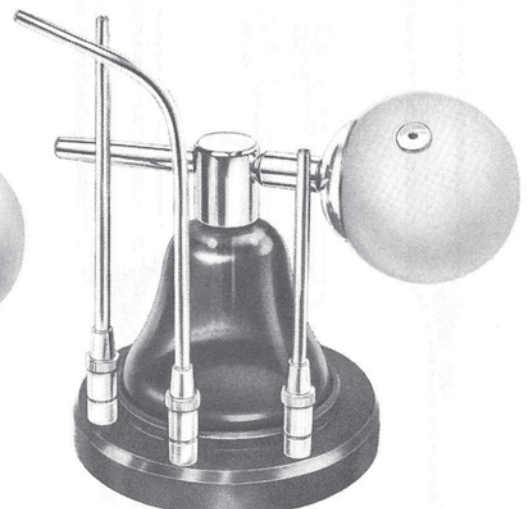

KABIERSKE
44.090.01
30 cc



44.091.03



44.091.04
4 mm Ø



44.091.15
15 mm Ø



44.091.17
17 mm Ø



44.091.22
22 mm Ø

POLITZER

44.091.00 = incl. 44.091.15, 44.091.17, 44.091.22, 44.091.03

44.091.01 = incl. 44.091.15, 44.091.17, 44.091.22, 44.091.03, 44.091.04

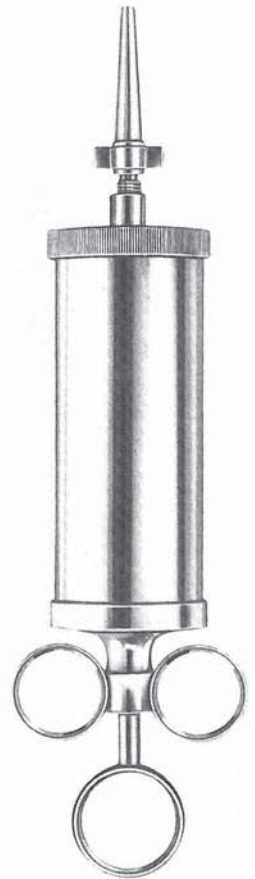

ml	REINER
50	44.096.50
75	44.096.75
100	44.097.10
150	44.097.15

**Küretten · Currettes ·
 Currettes · Curetas ·
 Curette**



BUCK

	Fig. 00	0	1	2	3	4	5
stumpf · blunt mousses romas smusse	44.109.00	44.110.00	44.110.01	44.110.02	44.110.03	44.110.04	44.110.05
scharf · sharp tranchantes cortantes taglianti	44.111.00	44.112.00	44.112.01	44.112.02	44.112.03	44.112.04	44.112.05
stumpf · blunt mousses romas smusse	44.114.00	44.115.00	44.115.01	44.115.02	44.115.03	44.115.04	44.115.05
scharf · sharp tranchantes cortantes taglianti	44.116.00	44.117.00	44.117.01	44.117.02	44.117.03	44.117.04	44.117.05

Katheter, Parazentesenadeln, Ohrmesser, Ohröffel
 Catheters, Paracentesis Needles, Ear Knives, Ear Spoons
 Sondes, Aiguilles à paracentèse, Couteaux auriculaires, Cuillers
 Cateteres, Aguja para paracentesis, Cuchillos auriculares, Cucharas
 Cateteri, Aghi per paracentesi, Coltelli auricolari, Cucchiari

dimeda[®]

SURGICAL INSTRUMENTS

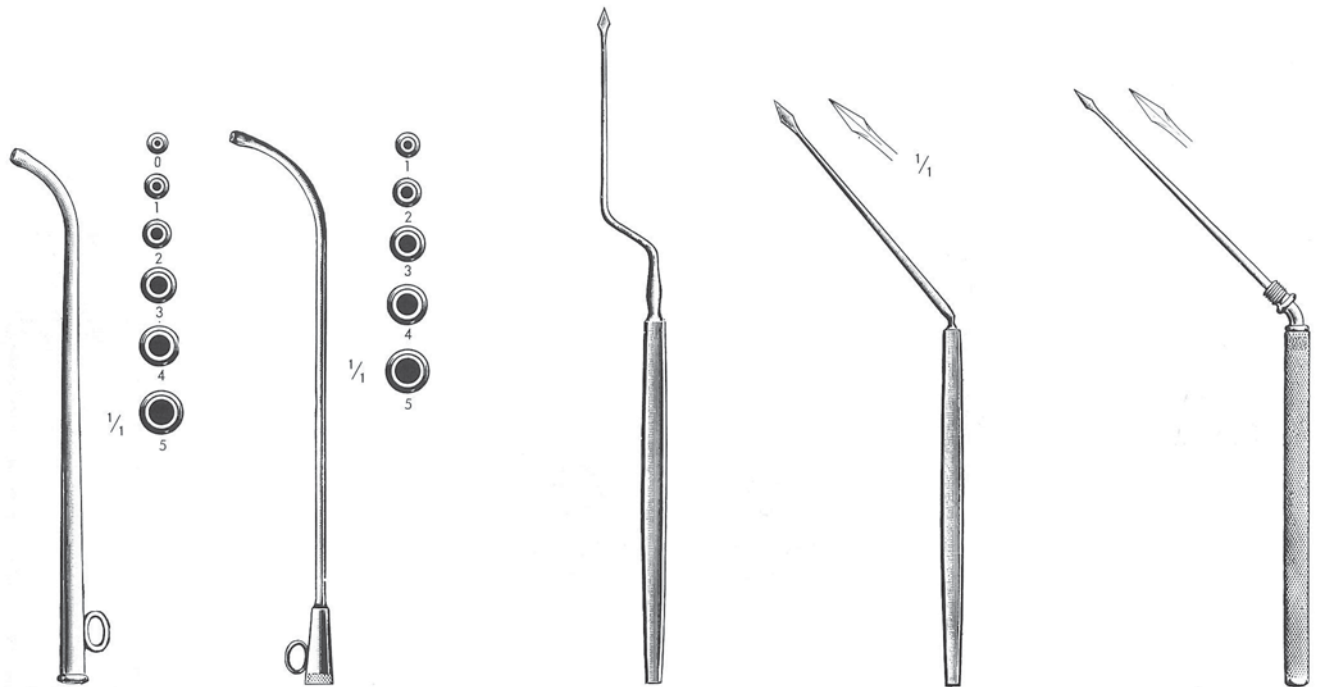

Fig.	HARTMANN	ITARD
0	44.131.00	
1	44.131.01	44.133.01
2	44.131.02	44.133.02
3	44.131.03	44.133.03
4	44.131.04	44.133.04
5	44.131.05	44.133.05

POLITZER
44.150.18
18 cm

POLITZER
44.151.16
16,5 cm

POLITZER
44.153.16



POLITZER
44.160.15
15 cm

SEXTON
44.162.18
18 cm

SEXTON
44.164.17
17 cm

SEXTON
44.165.17
17 cm

GROSS
44.170.12
12 cm

GROSS
44.171.12
12 cm

Schlingen, Hakchen, Pinzetten, Schnurer
 Loops, Hooklets, Dressing Forceps, Snares
 Anses, Crochets, Pincas, Serrenoead
 Asas, Granchitos, Pinzas, Cierranudos
 Anse, Uncinetti, Pinze, Serranodi

dimeda[®]

SURGICAL INSTRUMENTS

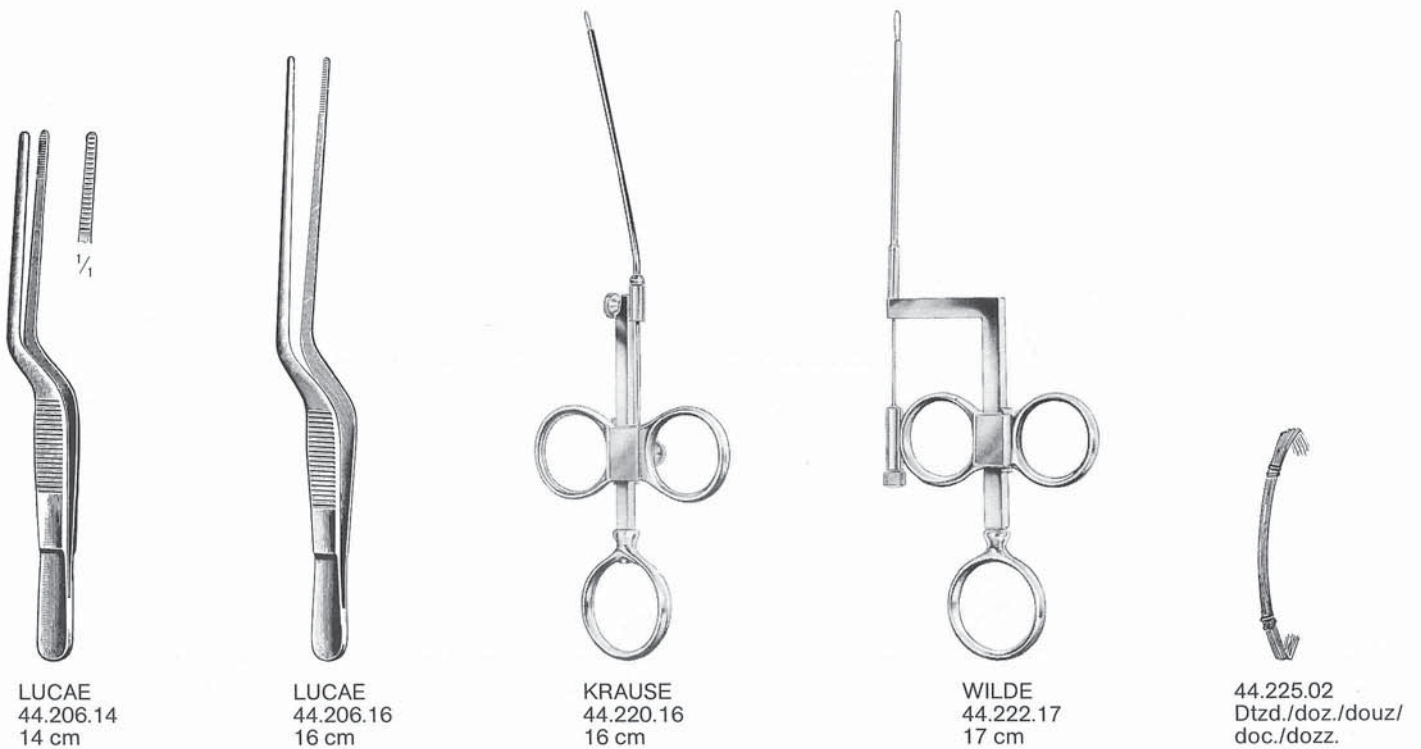
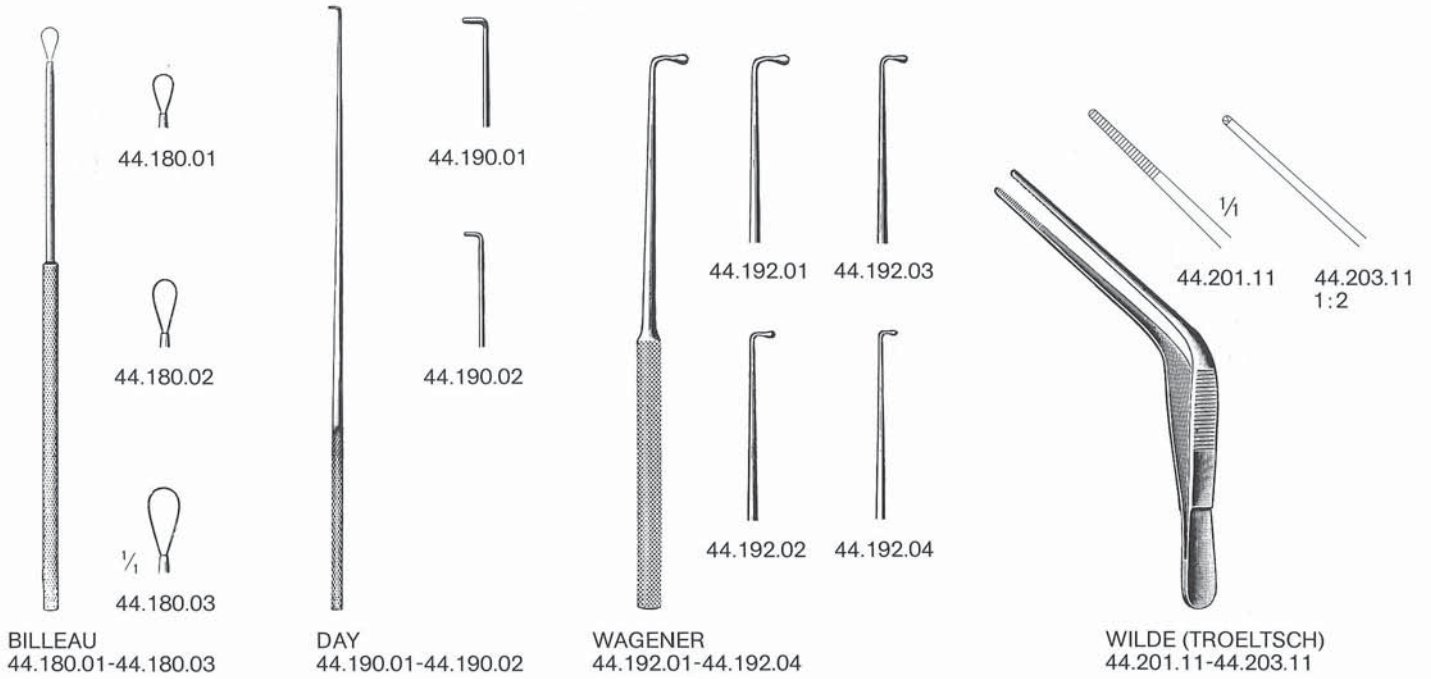



TILLEY
 44.243.14
 14 cm



LITTAUER
 44.245.12
 12 cm

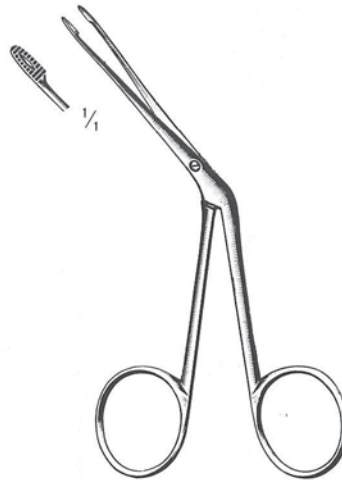

HARTMANN
 44.241.12
 12 cm

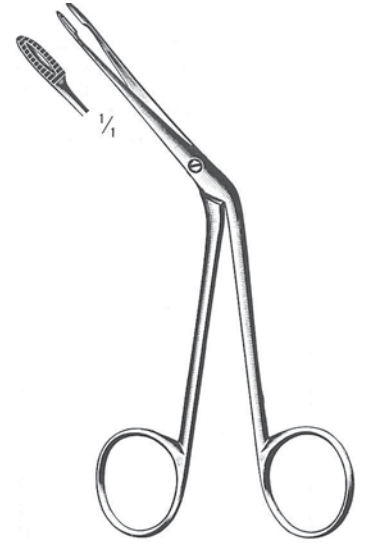

HARTMANN
 44.241.14
 14 cm



QUIRE
 44.251.10
 10 cm

Fremdkörperheber
 Foreign Body Levers
 Leviers pour corps étrangers
 Elevadores para cuerpos extranjeros
 Leve per corpi estranei



BUCK
 44.253.11
 11 cm



44.255.08-44.275.08



HARTMANN-WULLSTEIN
 44.255.08
 8,5 cm



HARTMANN-WULLSTEIN
 44.257.08
 8,5 cm



cm	HARTMANN
8,5	44.261.08
14,0	44.261.14
16,0	44.261.16



cm	HARTMANN
8,5	44.263.08
14,0	44.263.14



HARTMANN
 44.265.08
 8,5 cm



Ø mm	HARTMANN
2,0	44.267.20
2,5	44.267.25
3,0	44.267.30
8,5 cm	

○ 3 mm



HARTMANN
 44.269.30
 8,5 cm



STRUEMPEL
 44.271.08
 8,5 cm



HARTMANN
 44.273.08
 8,5 cm

○ 2 mm



HARTMANN-HOFFMANN
 44.275.08
 8,5 cm

Mikro-Ohrscherchen
 Micro Ear Scissors
 Ciseaux auriculaires micro
 Tijeras auriculares micro
 Forbici auricolari micro



44.310.40-44.322.70

gerade
 straight
 droite
 recta
 retta



BELLUCCI
 44.310.40
 micro mini
 4 mm

gerade
 straight
 droite
 recta
 retta



BELLUCCI
 44.312.55
 micro standard
 5,5 mm

aufgebogen
 bent upwards
 courbée vers le haut
 curva por arriba
 curva in alto



BELLUCCI
 44.313.55
 micro standard
 5,5 mm

links
 left
 gauche
 izquierda
 sinistra



BELLUCCI
 44.315.55
 micro standard
 5,5 mm

rechts
 right
 droite
 derecha
 retta



BELLUCCI
 44.317.55
 micro standard
 5,5 mm

gerade
 straight
 droite
 recta
 retta



SHEA
 44.320.70
 7,0 mm

links
 left
 gauche
 izquierda
 sinistra



SHEA
 44.321.70
 7,0 mm

rechts
 right
 droite
 derecha
 retta



SHEA
 44.322.70
 7,0 mm

gerieft, gerade
 serrated, straight
 striée, droite
 estriada, recta
 con scanalatura, retta



44.350.40
 4 mm

gerieft, gerade
 serrated, straight
 striée, droite
 estriada, recta
 con scanalatura, retta



44.350.70
 7 mm

glatt, gerade
 smooth, straight
 lisse, droite
 lisa, recta
 liscia, retta



44.352.40
 4 mm

Mikro-Ohrzängchen
 Micro Ear Forceps
 Pincés auriculaires micro
 Pinzas auriculares micro
 Pinze auricolari micro

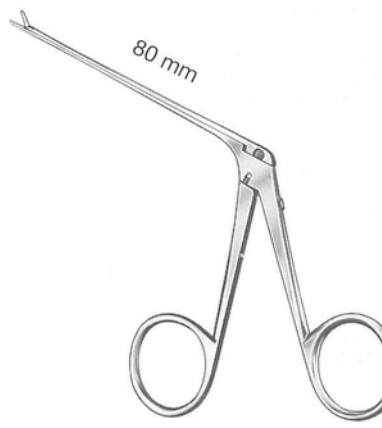

44.350.40-44.360.35

links, gerieft
 left, serrated
 gauche, striée
 izquierda, estriada
 sinistra, con scanalatura



44.353.60
 6 mm

rechts, gerieft
 right, serrated
 droite, striée
 derecha, estriada
 retta, con scanalatura



44.355.60
 6 mm

aufgebogen, gerieft
 bent upwards, serrated
 courbée vers le haut, striée
 curva por arriba, estriada
 curva in alto, con scanalatura



44.357.40
 4 mm

abwärts gebogen, gerieft
 downwards, serrated
 courbée en bas, striée
 curva hacia abajo, estriada
 curva in basso, con scanalatura



44.359.40
 4 mm

gerieft, gerade
 serrated, straight
 striée, droite
 estriada, recta
 con scanalatura, retta



44.360.35
 3,5 mm

rechts
 right
 droite
 derecha
 retta



44.362.45
 4,5 mm

links
 left
 gauche
 izquierda
 sinistra



44.363.45
 4,5 mm

gerade
 straight
 droite
 recta
 retta



44.365.45
 4,5 mm



44.367.50
 5,0 mm



44.369.50
 5,0 mm

abgebogen
 bent downwards
 courbée vers le bas
 curva por abajo
 curva in baso



GREVEN
 44.370.50
 5,0 mm

abgebogen
 bent downwards
 courbée vers le bas
 curva por abajo
 curva in baso



McGEE
 44.371.40
 0,8x4,0 mm



44.362.45-44.371.40

Hammerkopf-Zwickzängchen
 Malleus Nippers
 Pincas pour la tête du marteau
 Pinzas para la cabeza del martillo
 Pinze per la testa del martello

micro



44.385.01

aufwärts
 upward
 en haut
 arriba
 in alto

mini



44.387.01



44.385.02

abwärts
 downward
 en bas
 abajo
 in basso



44.387.02



DIETER
 44.385.01-44.387.02

Modelle mit Ringgriff
 Ring Handle Patterns
 Modèles manches à anneaux
 Modelos mangos con anillos
 Modelli manici con anelli

Modelle mit Bleistiftgriff
 Pencil Handle Patterns
 Modèles manches crayon
 Modelos mango en forma de lapiz
 Modelli manico forma matita

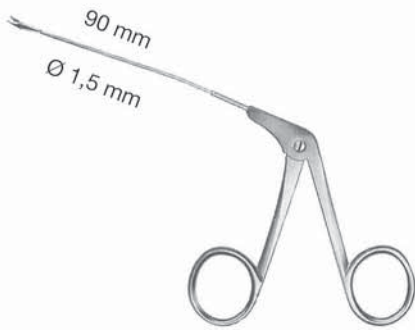

WULLSTEIN
 44.410.00-44.419.00
 micro
 RG

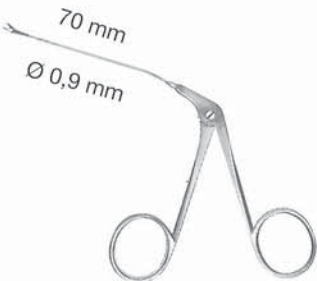

WULLSTEIN
 44.420.00-44.429.00
 micro-mini
 RG

44.410.00		44.430.00
44.412.00		44.432.00
44.413.00		44.433.00
44.415.00		44.435.00
44.417.00		44.437.00
44.419.00		44.439.00
		44.439.08
44.420.00		44.440.00
44.422.00		44.442.00
44.423.00		44.443.00
44.425.00		44.445.00
44.427.00		44.447.00
44.429.00		44.449.00

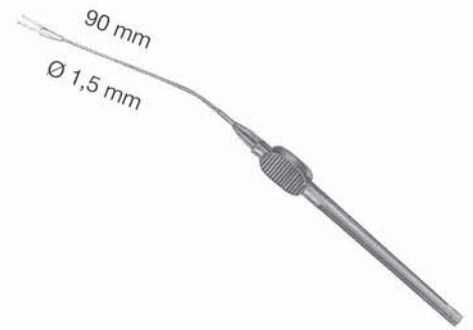

44.430.00-44.439.08
 micro
 BG

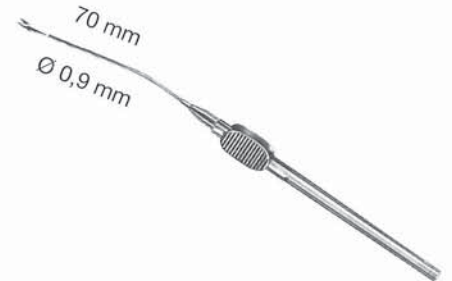

44.440.00-44.449.00
 micro-mini
 BG

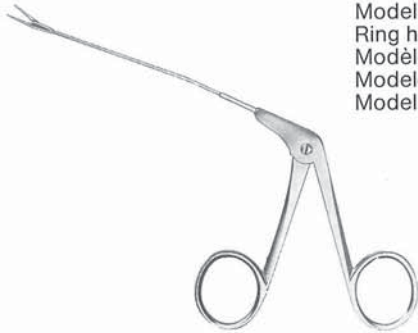

Modelle mit Ringgriff
 Ring handle Patterns
 Modèles manches à anneaux
 Modelos mangos con anillos
 Modelli manici con anelli

44.510.00-44.549.00
 micro
 RG

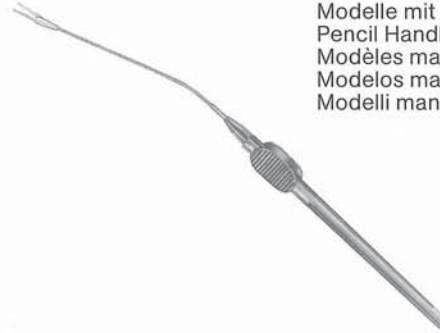

Modelle mit Bleistiftgriff
 Pencil Handle Patterns
 Modèles manches crayon
 Modelos mango en forma de lapiz
 Modelli manico forma matita

44.610.00-44.649.00
 micro
 BG

44.510.00		44.610.00
44.511.00		44.611.00
44.513.00		44.613.00
44.514.00		44.614.00
44.515.00		44.615.00
44.516.00		44.616.00
44.517.00		44.617.00
44.519.00		44.619.00
44.520.00		44.620.00
44.521.00		

Ø 1 mm Ø 1,5 mm Ø 2 mm Ø 2,5 mm

44.522.00	44.528.00	44.534.00	44.540.00
44.523.00	44.529.00	44.535.00	44.541.00
44.525.00	44.531.00	44.537.00	44.543.00
44.527.00	44.533.00	44.539.00	44.545.00

Ø 1 mm Ø 1,5 mm Ø 2 mm Ø 2,5 mm

44.622.00	44.628.00	44.634.00	44.640.00
44.623.00	44.629.00	44.635.00	44.641.00
44.625.00	44.631.00	44.637.00	44.643.00
44.627.00	44.633.00	44.639.00	44.645.00

44.546.00		44.646.00
44.547.00		44.647.00
44.548.00		44.648.00
44.549.00		44.649.00

Modelle mit Ringgriff
 Ring Handle Patterns
 Modèles manches à anneaux
 Modelos mangos con anillos
 Modelli manici con anelli



44.550.00-44.589.00
 micro-mini
 RG

Modelle mit Bleistiftgriff
 Pencil Handle Patterns
 Modèles manches crayon
 Modelos mango en forma de lapiz
 Modelli manico forma matita



44.650.00-44.689.00
 micro-mini
 BG

44.550.00		44.650.00
44.551.00		44.651.00
44.553.00		44.653.00
44.554.00		44.654.00
44.555.00		44.655.00
44.556.00		
44.557.00		44.657.00
44.559.00		44.659.00
44.560.00		44.660.00
44.561.00		
44.562.00		44.662.00
44.563.00		44.663.00
44.565.00		44.665.00
44.567.00		44.667.00
44.586.00		44.686.00
44.587.00		44.687.00
44.588.00		44.688.00
44.589.00		44.689.00



SCHUKNECHT
 44.701.01



SCHUKNECHT
 44.701.02



SCHUKNECHT
 44.703.15
 15,5 cm



WULLSTEIN
 44.704.15
 15,5 cm



TABB
 44.705.15
 15,5 cm



PLESTER
 44.706.35
 15,5 cm/3,5 mm Ø



ROSEN
 44.709.10-44.709.30



44.709.10
 1,0 mm



44.709.14
 1,4 mm



44.709.16
 1,6 mm



44.709.20
 2,0 mm



44.709.26
 2,6 mm



44.709.28
 2,8 mm



44.709.30
 3,0 mm



BARBARA
 44.710.15



BARBARA
 44.711.15



BARBARA
 44.713.15



ROSEN
 44.715.15



	25°	45°	90°	
mm	BARBARA	BARBARA	BARBARA	BARBARA
0,3	44.720.03	44.722.03	44.724.03	44.725.05 = 0,5 mm
0,6	44.720.06	44.722.06	44.724.06	44.725.10 = 1,0 mm
1,0	44.720.10	44.722.10	44.724.10	
1,2		44.722.12	44.724.12	
1,5		44.722.15	44.724.15	
2,0		44.722.20	44.724.20	
2,5		44.722.25	44.724.25	

44.710.15-44.725.10



mm	90°	90°	mm	McGEE	McGEE	BARBARA
0,3	44.730.03	44.732.03	0,5	44.733.05	44.735.05	44.736.15
0,6	44.730.06	44.732.06	1,0	44.733.10	44.735.10	15,5 cm
1,0	44.730.10	44.732.10				

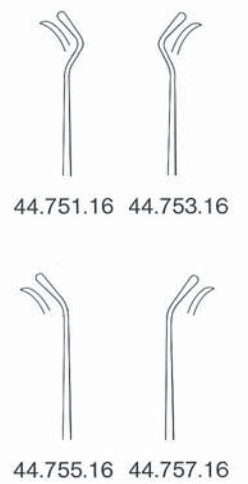

44.751.16 44.753.16
 44.755.16 44.757.16

ROSEN
 44.737.15
 15,5 cm

mm	25°	25°	45°	45°
0,3	44.741.03	44.743.03	44.745.03	44.747.03
0,6	44.741.06	44.743.06	44.745.06	44.747.06
1,0	44.741.10	44.743.10	44.745.10	44.747.10

FISCH
 44.751.16-44.757.16

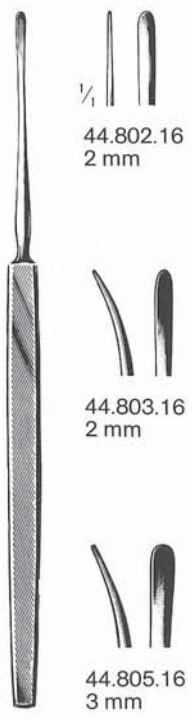

LEMPERT
 44.802.16-44.805.16

1/2
 44.802.16
 2 mm

44.803.16
 2 mm

44.805.16
 3 mm

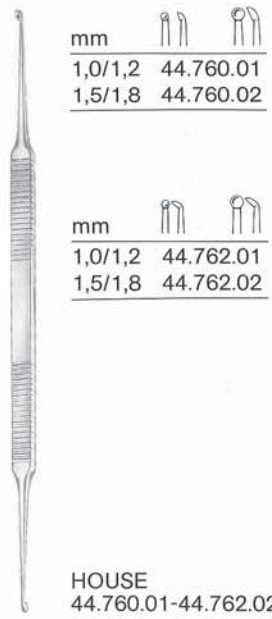

mm
 1,0/1,2 44.760.01
 1,5/1,8 44.760.02

mm
 1,0/1,2 44.762.01
 1,5/1,8 44.762.02

HOUSE
 44.760.01-44.762.02



3,5 mm
 44.766.35
 4 mm
 44.766.40
 4,5 mm
 44.766.45
 5 mm
 44.766.50

HOUSE
 44.766.35-44.766.50



LEMPERT
 44.807.20
 20,5 cm

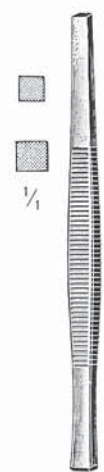

mm
 2x2 44.810.02
 3x3 44.810.03



MUCK
 44.812.13
 13 cm

dimeda[®]

SURGICAL INSTRUMENTS