

13

Atraumatische Klemmen

Atraumatic Forceps

Pinces atraumatique

Pinzas atraumatico

Pinze atraumatico



cm — HALSTEAD-MOSQUITO —
 12,0 13.080.12 13.081.12
 15,0 13.080.15 13.081.15



cm — PEAN —
 14,0 13.082.14 13.083.14
 16,0 13.082.16 13.083.16
 18,0 13.082.18 13.083.18
 20,0 13.082.20 13.083.20

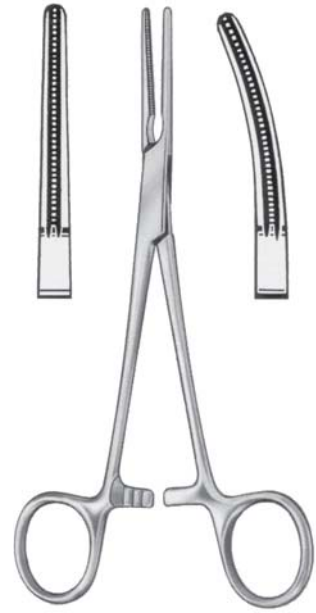

cm — RANKIN —
 16,0 13.084.16 13.085.16



cm — DE BAKEY —
 12,0 13.102.12 13.103.12

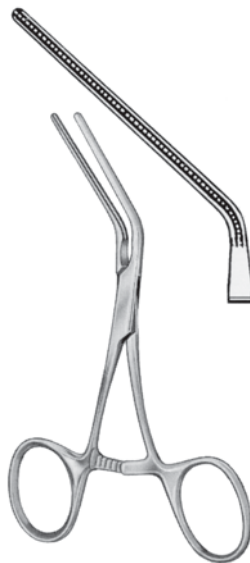

DE BAKEY
 13.111.12
 12,0 cm



DE BAKEY
 13.113.12
 12,0 cm



DE BAKEY
 13.121.12
 12,0 cm



cm	LEES
23,0	13.131.23
25,0	13.131.25

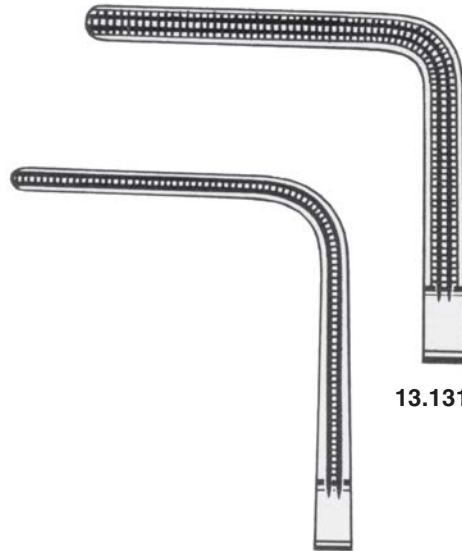

13.131.25

13.131.23

Bronchusklemmen
Bronchus Forceps
Pincés-Clamps à Bronches
Pinzas clamps bronquiales
Pinze per bronchi



LEES
13.133.25
25,0 cm

Coarctationsklemmen
 Coarction Clamps
 Pincès à coarctacion
 Pinzas para coarctación
 Pinze per coartazione

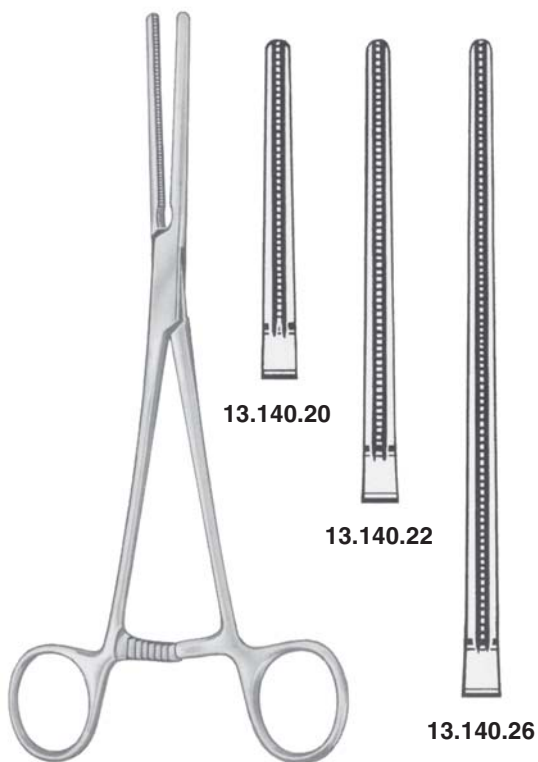

cm	POTTS
20,0	13.140.20
22,5	13.140.22
26,0	13.140.26

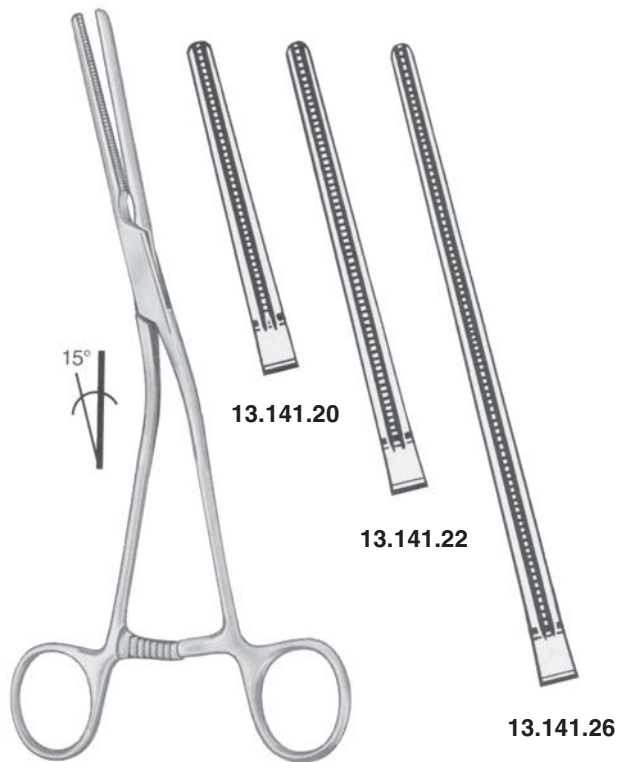

cm	GLOVER
20,0	13.141.20
22,5	13.141.22
26,0	13.141.26

Atraumatische Gefäßklemmen
 Atraumatic Hemostatic Forceps
 Pincès hémostatiques atraumatiques
 Pinzas hemostáticas atraumáticas
 Pinze emostatiche atraumatiche

dimeda[®]

SURGICAL INSTRUMENTS

Anastomosenklemmen
 Anastomosis Clamps
 Pincès à anastomose
 Pinzas para anastomosis
 Pinze per anastomosi



cm	<u>POTTS / GLOVER</u>
21,0	13.151.21
24,0	13.151.24

13.151.21

13.151.24



cm	<u>GLOVER</u>
18,0	13.153.18
22,0	13.153.22

13.153.18

13.153.22

Atraumatische Gefäßklemmen
 Atraumatic Hemostatic Forceps
 Pincés hémostatiques atraumatiques
 Pinzas hemostáticas atraumáticas
 Pinze emostatiche atraumatiche

dimeda[®]

SURGICAL INSTRUMENTS

Vascularklemme löffelförmig
 Vascular Clamps Spoon Shaped
 Pince vasculaire forme cuiller
 Pinza vascular forma cuchara
 Pinza vascolare forma cucchiaio



13.161.21

13.161.26

Peripher-Vascularklemmen
 Peripheral Vascular Forceps
 Pincés vasculaires périph.
 Pinzas vasculares perif.
 Pinze vascolari perif.

cm	GLOVER
21,0	13.161.21
26,0	13.161.26

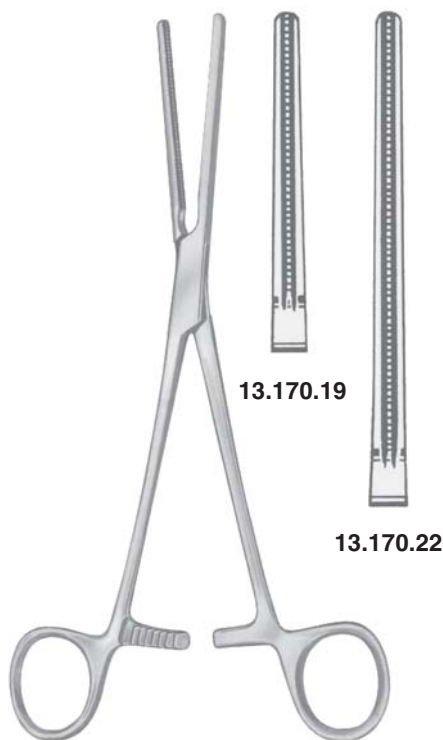

13.170.19

13.170.22

cm	DE BAKEY
18,0	13.170.19
22,0	13.170.22



13.171.19

13.171.22

cm	DE BAKEY
18,0	13.171.19
22,0	13.171.22

Atraumatische Mehrzweckklemmen
 Atraumatic Multi-Purpose Clamps
 Pincés-clamps polyvalentes
 Pinzas clamps para usos varios
 Pinze atraumatiche per diversi usi



DARDIK

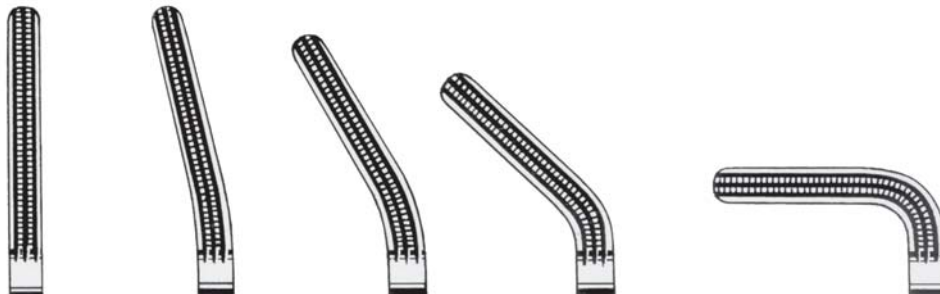

cm	0°	15°	30°	45°	90°
14,0	--	--	--	--	13.172.90
15,0	13.172.00	13.172.15	13.172.30	13.172.45	--

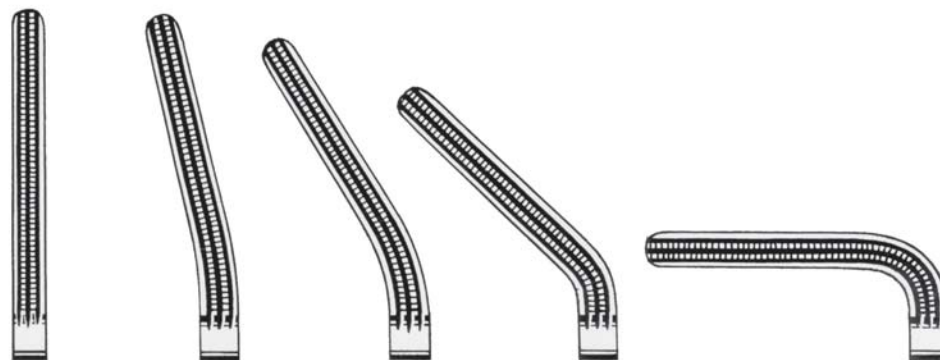

cm	0°	15°	30°	45°	90°
16,0	--	--	--	--	13.174.90
17,0	13.174.00	13.174.15	13.174.30	13.174.45	--

Peripher-Vascularklemmen
 Peripheral Vascular Forceps
 Pincés vasculaires périph.
 Pinzas vasculares perif.
 Pinze vascolari perif.

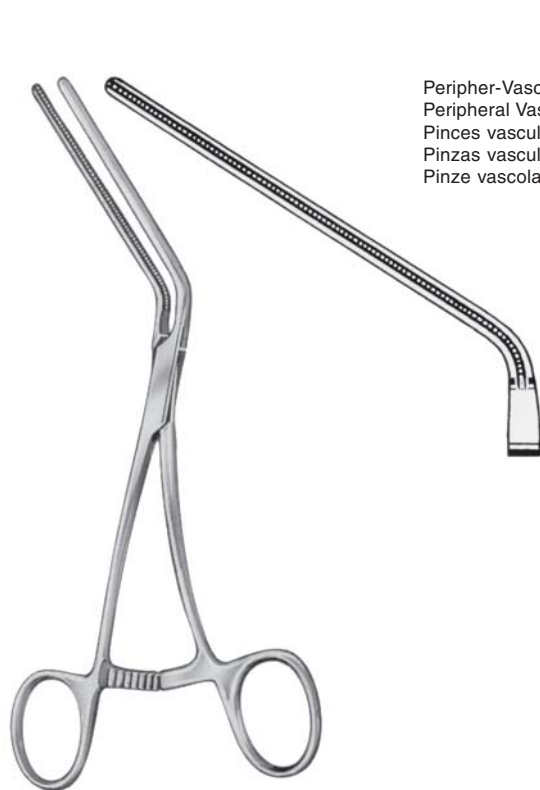

LELAND-JONES
13.181.19
 19,0 cm



DE BAKEY
13.181.26
 26,0 cm



cm	DE BAKEY
19,0	13.183.19
20,0	13.183.20

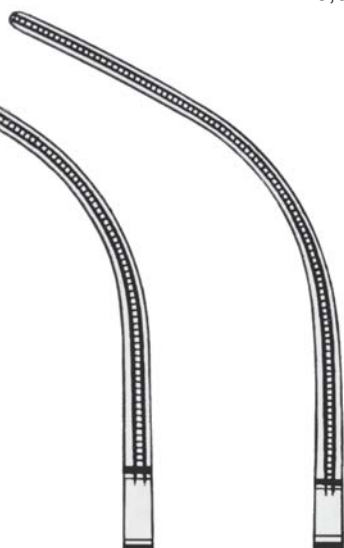

13.183.19

13.183.20



DE BAKEY
13.191.16
 16,0 cm



BAINBRIDGE



13.196.15
15,0 cm



13.196.18
18,0 cm



13.197.15
15,0 cm



13.197.18
18,0 cm

Peripher-Vascularklemmen
 Peripheral Vascular Forceps
 Pincès vasculaires périph.
 Pinzas vasculares perif.
 Pinze vascolari perif.



LELAND JONES
13.202.19
19,0 cm



13.203.19
19,0 cm



LELAND JONES

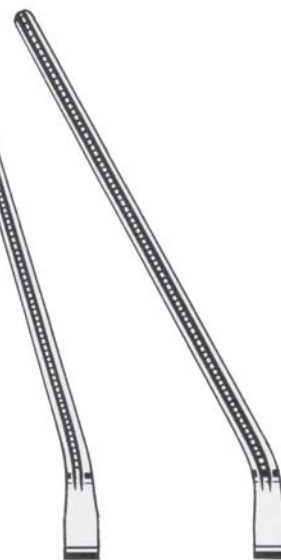

13.205.19
19,0 cm

Aortaklemmen
Aortic Clamp
Pince-clamp à aorte
Pinza clamp para aorta
Pinza per aorta



LIDDLE
13.209.27
27,0 cm



Aorta-Anastomosenklemmen
Aorta-Anastomosis Clamps
Pincés-clamps pour anastomoses d'aorte
Pinzas clamps para anastomosis de aorta
Pinze aortiche



LAMBERT KAY
13.211.20
20,0 cm

Iliaca-Klemme
Iliac Clamp
Pince-clamp à iliaque
Pinza clamp para iliaca
Pinza per iliaca



LAMBERT KAY
13.213.20
20,0 cm



DE BAKEY
13.215.20
20,0 cm



WEBER
13.217.26
26,0 cm



WEBER
13.219.26
26,0 cm

Aorta-Aneurysma-Klemmen
Aorta-Aneurysm Clamps
Pincés-clamps pour aneurysme d'aorte
Pinzas clamps para aneurisma de aorta
Pinze per aneurisma di aorta



DE BAKAY



13.221.24
24,0 cm

13.221.27
27,0 cm

13.221.31
31,0 cm

13.221.35
35,0 cm

Aorta-Aneurysma-Klemmen
Aorta-Aneurysm Clamps
Pincés-clamps pour aneurysme d'aorte
Pinzas clamps para aneurisma de aorta
Pinze per aneurisma di aorta



DE BAKEY BAHNSON



13.223.24
24,0 cm

13.223.25
25,0 cm

13.223.26
26,0 cm

Aorta-Aneurysma-Klemmen
Aorta-Aneurysm Clamps
Pinces-clamps pour aneurysme d'aorte
Pinzas clamps para aneurisma de aorta
Pinze per aneurisma di aorta



DE BAKEY
13.225.28
28,0 cm



DE BAKEY
13.227.28
28,0 cm

Atraumatische Gefäßklemmen
Atraumatic Hemostatic Forceps
Pinces hémostatiques atraumatiques
Pinzas hemostáticas atraumáticas
Pinze emostatiche atraumatiche

dimeda®

SURGICAL INSTRUMENTS

Atraumatische Mehrzweckklemmen
Atraumatic Multi-Purpose Clamps
Pinces-clamps polyvalentes
Pinzas clamps para usos varios
Pinze atraumatiche per diversi usi



DE BAKEY MORRIS

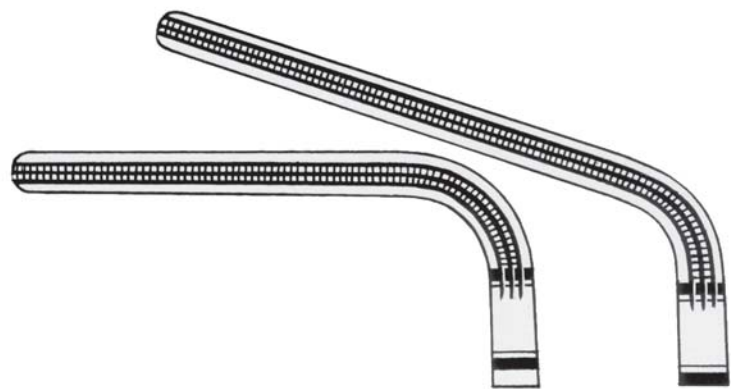

13.229.18
18,0 cm

13.229.20
20,0 cm



13.229.23
23,0 cm

13.229.25
25,0 cm

Atraumatische Gefäßklemmen
Atraumatic Hemostatic Forceps
Pinces hémostatiques atraumatiques
Pinzas hemostáticas atraumáticas
Pinze emostatiche atraumatiche

dimeda[®]

SURGICAL INSTRUMENTS

Atraumatische Mehrzweckklemmen
Atraumatic Multi-Purpose Clamps
Pinces-clamps polyvalentes
Pinzas clamps para usos varios
Pinze atraumatiche per diversi usi

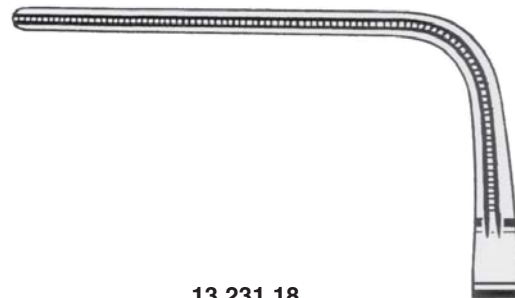

13.231.18
18,0 cm

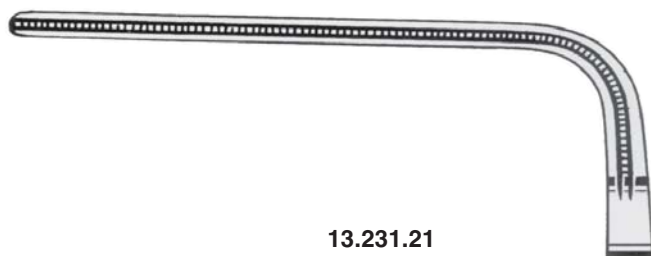

13.231.21
21,0 cm

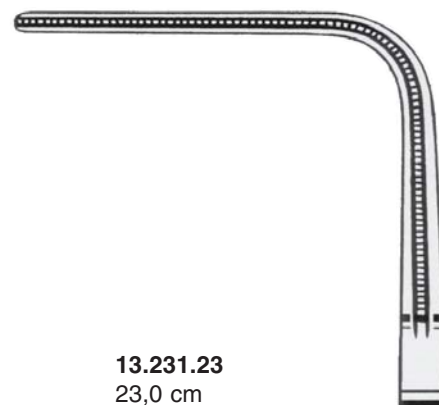

13.231.23
23,0 cm



DE BAKEY



13.231.27
27,0 cm

Atraumatische Gefäßklemmen
Atraumatic Hemostatic Forceps
Pincés hémostatiques atraumatiques
Pinzas hemostáticas atraumáticas
Pinze emostatiche atraumatiche

dimeda[®]

SURGICAL INSTRUMENTS

Aorta-Aneurysma-Klemmen
Aorta-Aneurysm Clamps
Pincés-clamps pour aneurysme d'aorte
Pinzas clamps para aneurisma de aorta
Pinze per aneurisma di aorta



DE BAKEY



13.241.25
25,0 cm

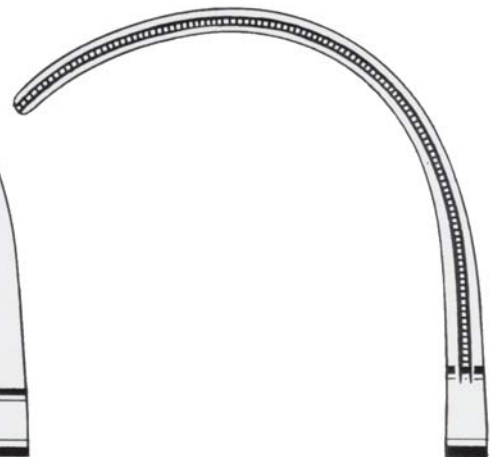

13.241.26
26,0 cm

Atraumatische Gefäßklemmen
Atraumatic Hemostatic Forceps
Pinces hémostatiques atraumatiques
Pinzas hemostáticas atraumáticas
Pinze emostatiche atraumatiche

dimeda[®]

SURGICAL INSTRUMENTS

Bronchus-Klemmen
Bronchus Clamps
Pinces pour les bronches
Pinzas bronquiales
Pinze per bronchi

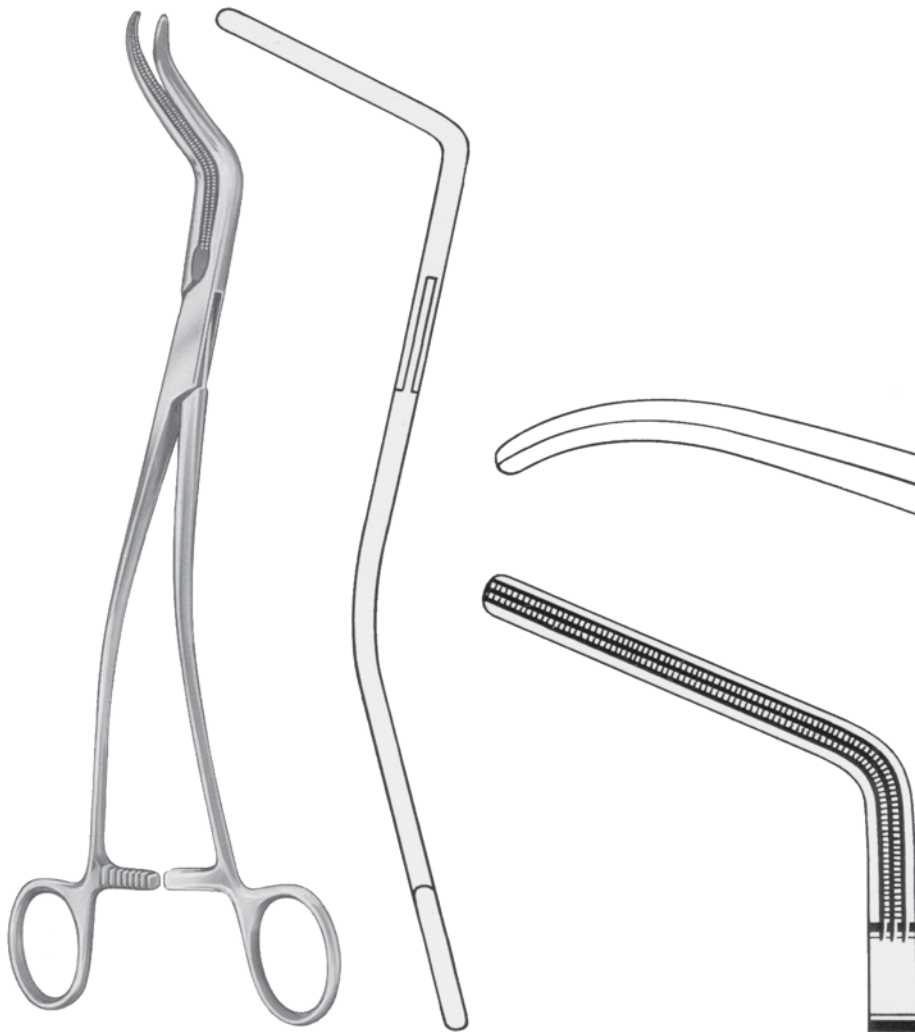

DE BAKEY
13.247.27
27,0 cm



DE BAKEY

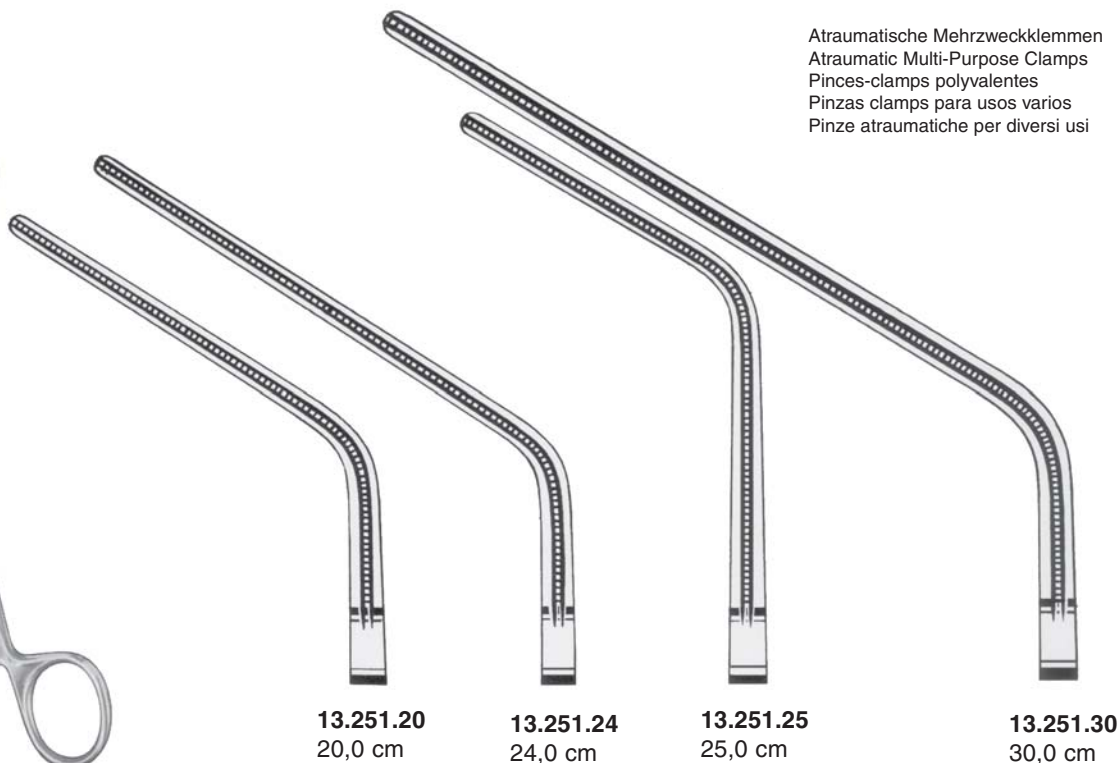

Atraumatische Mehrzweckklemmen
 Atraumatic Multi-Purpose Clamps
 Pincés-clamps polyvalentes
 Pinzas clamps para usos varios
 Pinze atraumatiche per diversi usi

13.251.20
20,0 cm

13.251.24
24,0 cm

13.251.25
25,0 cm

13.251.30
30,0 cm



SATINSKY



13.253.20
20,0 cm

13.253.24
24,0 cm

13.253.25
25,0 cm

13.253.26
26,0 cm

13.253.27
27,0 cm

Anlegezange für Clips
 Applying for Clips
 Appicateur pour clips
 Pinza para aplicar clips
 Applicatore per clips

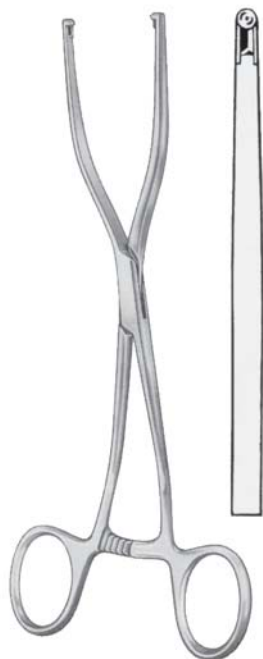

EDWARDS
13.258.00

Clips
 Clips
 Clips
 Clips
 Clips



mm	EDWARDS
6	13.258.06
12	13.258.12



WYLIE



13.259.01
 Fig. 1
 21,0 cm

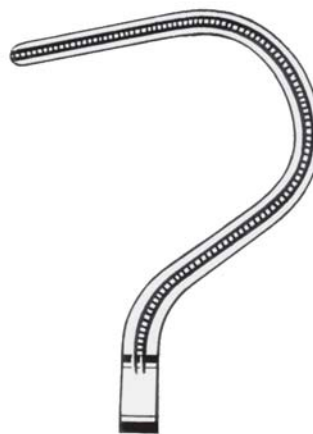

13.259.02
 Fig. 2
 22,0 cm



DE BAKEY SATINSKY



13.261.23
Fig. 1
23,0 cm

13.261.24
Fig. 2
24,0 cm

13.261.25
Fig. 3
25,0 cm

Aurikelklemmen
Auricle Clamps
Pincès auriculaires
Pinzas para aurícula
Pinze ventricolari



HARKEN

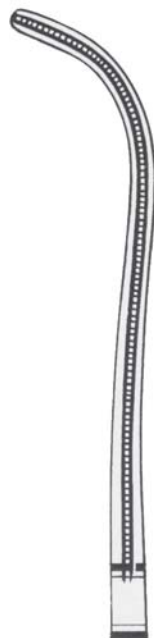

13.263.25
Fig. 1
25,0 cm

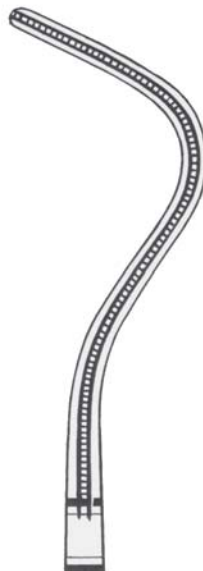

13.265.24
Fig. 2
24,0 cm



13.267.24
Fig. 3
24,0 cm



13.269.24
Fig. 4
24,0 cm

Atraumatische Gefäßklemmen
Atraumatic Hemostatic Forceps
Pincés hémostatiques atraumatiques
Pinzas hemostáticas atraumáticas
Pinze emostatiche atraumatiche

dimeda[®]

SURGICAL INSTRUMENTS

Peripheal-Gefäßklemmen
Peripheal Vascular Clamps
Pincés-clamps, vasculaires périphériques
Pinzas para vasos periféricos
Pinze vascolari periferali



DALE
13.271.18
18,0 cm



DALE

13.273.17
17,0 cm



13.273.18
18,0 cm



13.273.19
19,0 cm



DE BAKEY
13.281.17
17,0 cm



BECK
13.283.17
17,0 cm

Präparier- und Ligaturklemmen
Dissecting and Ligature Clamps
Pincas à dissection et passe-fil
Pinzas de disección y para ligaduras
Pinze per dissezione e per legature



DE BAKEY
13.285.24
24,0 cm



DE BAKEY
13.287.24
24,0 cm

Atraumatische Mehrzweckklemmen
Atraumatic Multi-Purpose Clamps
Pincès-clamps polyvalentes
Pinzas clamps para usos varios
Pinze atraumatiche per diversi usi



POTTS



13.288.21
21,0 cm



13.288.23
23,0 cm



13.288.27
27,0 cm



13.288.31
31,0 cm

Atraumatische Mehrzweckklemmen
Atraumatic Multi-Purpose Clamps
Pincès-clamps polyvalentes
Pinzas clamps para usos varios
Pinze atraumatiche per diversi usi



POTTS



13.289.21
21,0 cm

13.289.23
23,0 cm

13.289.27
27,0 cm

13.289.31
31,0 cm

Anastomosenklemmen, Kindergrößen
Anastomosis Clamps, Pediatric
Pincés à anastomose, pédiatriques
Pinzas para anastomosis, pediátricas
Pinze per anastomosi, pediatriche



DERRA

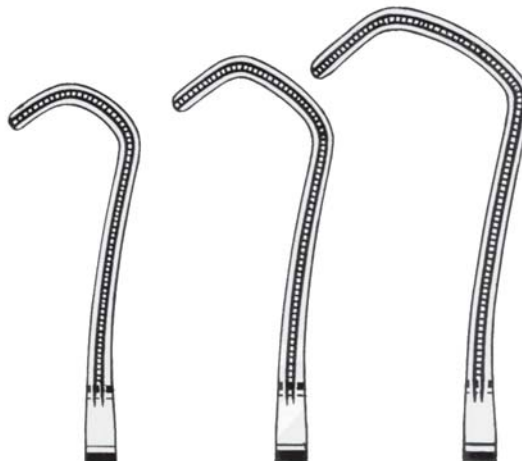

13.291.16
16,0 cm

13.291.17
17,0 cm

13.291.18
18,0 cm

Atraumatische Mehrzweckklemmen
Atraumatic Multi-Purpose Clamps
Pincés-clamps polyvalentes
Pinzas clamps para usos varios
Pinze atraumatiche per diversi usi



DE BAKEY
13.302.16
16,0 cm



DE BAKEY
13.302.17
17,0 cm



DE BAKEY
13.303.15
15,0 cm



DE BAKEY
13.307.17
17,0 cm

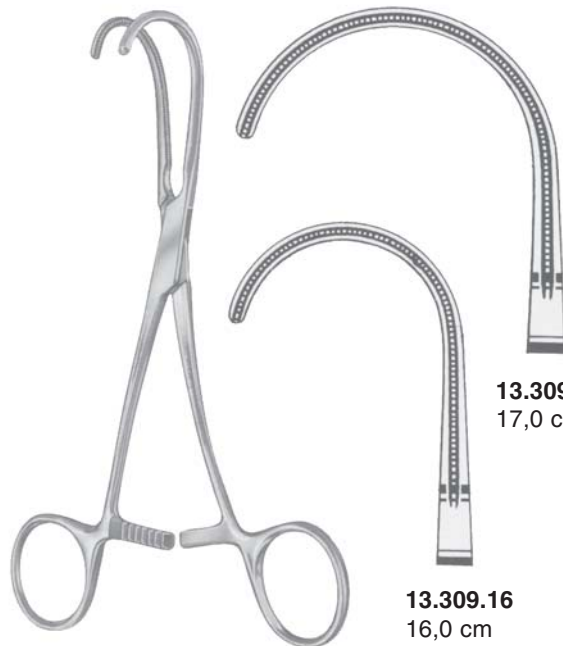

13.309.17
17,0 cm

13.309.16
16,0 cm

DE BAKEY

Atraumatische Mehrzweckklemmen
 Atraumatic Multi-Purpose Clamps
 Pincés-clamps polyvalentes
 Pinzas clamps para usos varios
 Pinze atraumatiche per diversi usi



DE BAKEY



13.311.14
14,0 cm



13.311.15
15,0 cm

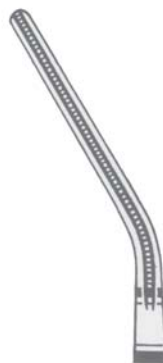

13.311.16
16,0 cm



GLOVER
13.321.17
17,0 cm

Anastomosenklemmen
 Anastomosis Clamps
 Pincés à anastomose
 Pinzas para anastomosis
 Pinze per anastomosi



DE BAKEY REYNOLDS



13.329.01
Fig. 1
17,5 cm



13.329.02
Fig. 2
17,5 cm



13.329.03
Fig. 3
16,5 cm



13.329.04
Fig. 3
16,5 cm



SUBRAMANIAN
13.331.15
15,0 cm



SUBRAMANIAN
13.333.16
16,0 cm



SUBRAMANIAN
13.335.16
16,0 cm



OCHSNER
13.337.23
23,0 cm

Aortaklemmen
Aortic Clamp
Pince-clamp à aorte
Pinza clamp para aorta
Pinza per aorta



DIETRICH
13.339.21
21,0 cm

Präparier- und Ligaturklemmen
 Dissecting and Ligature Clamps
 Pincas à dissection et passe-fil
 Pinzas de dissección y para ligaduras
 Pinze per dissezione e per legature

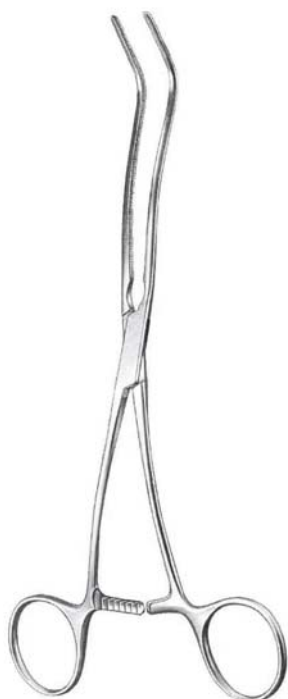

DE BAKEY
13.341.20
 20,0 cm

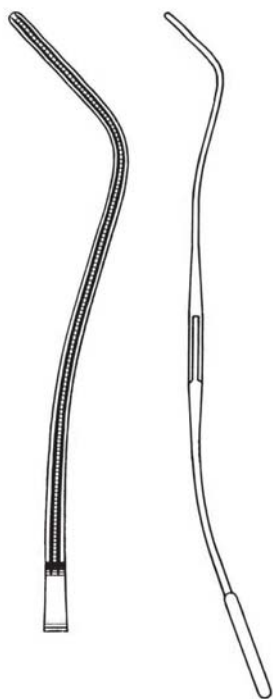

DE BAKEY

13.341.19
 19,0 cm

13.341.23
 23,0 cm

Carotis-Shuntklemmen
 Carotid Shunt Clamps
 Pincas pour carotide
 Pinzas para shunt carótido
 Pinze carotis



JAVID
13.343.18
 18,0 cm



JAVID
13.343.19
 19,0 cm

Profunda-Klemmen
 Profunda Clamps
 Pincas-clamps pour profunda
 Pinzas clamps para profunda
 Pinze per profunda



GREGORY

13.349.14
 14,0 cm

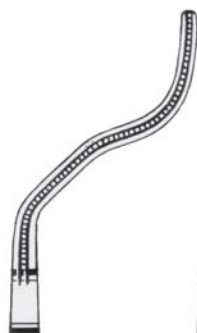

13.349.16
 16,0 cm

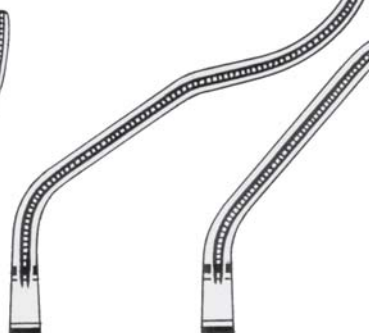

13.349.18
 18,0 cm

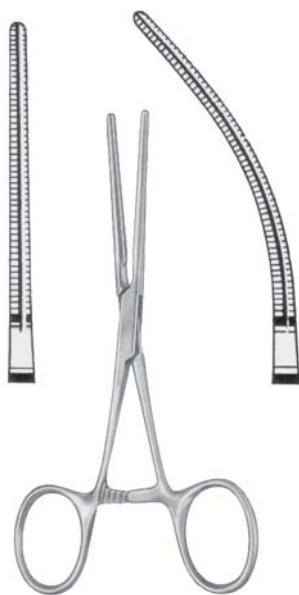

cm — COOLEY —
 13,0 **13.350.13** **13.351.13**



COOLEY
13.353.13
 13,5 cm



COOLEY
13.355.13
 13,0 cm



COOLEY
13.357.12
12,5 cm



COOLEY
13.359.10
10,5 cm



COOLEY
13.361.12
12,0 cm



COOLEY
13.363.13
13,5 cm

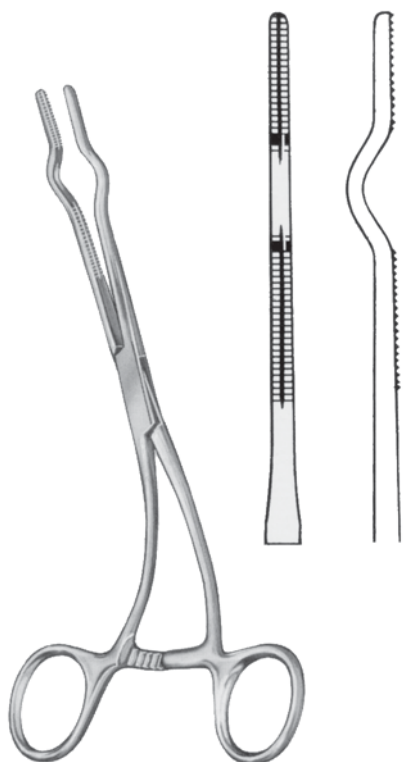

Fr./Charrière	COOLEY
24	13.371.24
26	13.371.26
28	13.371.28
30	13.373.30
32	13.373.32
36	13.373.36

cm	— COOLEY	↷
14,0	13.376.14	13.377.14
16,0	13.376.16	13.377.16



COOLEY
13.379.14
 14,0 cm

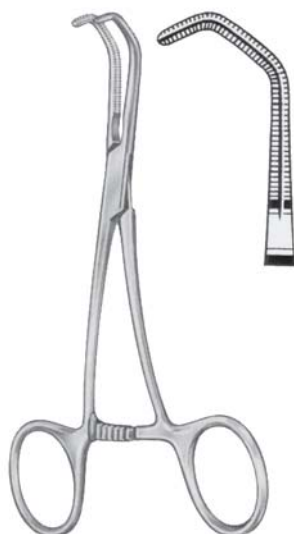

COOLEY
13.380.14
 14,0 cm



COOLEY
13.381.14
 14,0 cm



COOLEY
13.405.27
27,0 cm



COOLEY
13.410.17
17,0 cm

Atraumatische Gefäßklemmen
 Atraumatic Hemostatic Forceps
 Pincés hémostatiques atraumatiques
 Pinzas hemostáticas atraumáticas
 Pinze emostatiche atraumatiche

dimeda®

SURGICAL INSTRUMENTS

Atraumatische Mehrzweckklemmen
 Atraumatic Multi-Purpose Clamps
 Pincés-clamps polyvalentes
 Pinzas clamps para usos varios
 Pinze atraumatiche per diversi usi



COOLEY

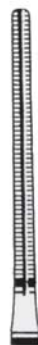

13.411.17
17,0 cm



13.413.17
17,0 cm



13.416.17
17,0 cm

Iliaca-Klemmen
 Iliac Clamps
 Pincés-clamps à iliaque
 Pinzas clamps para iliaca
 Pinze per iliaca



COOLEY
13.417.21
21,5 cm



Anastomosenklemmen
 Anastomosis Clamps
 Pincés à anastomose
 Pinzas para anastomosis
 Pinze per anastomosi



COOLEY
13.419.17
17,0 cm

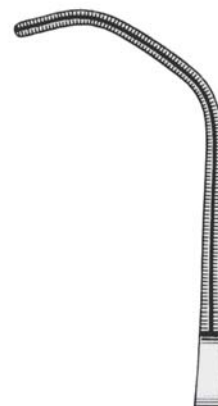



cm — COOLEY —
 14,0 13.420.14 13.421.14



COOLEY
 13.423.14
 14,0 cm



COOLEY
 13.425.14
 14,0 cm



COOLEY



13.427.15
 15,0 cm

13.427.16
 16,0 cm

Atraumatische Mehrzweckklemmen
 Atraumatic Multi-Purpose Clamps
 Pincas-clamps polyvalentes
 Pinzas clamps para usos varios
 Pinze atraumatiche per diversi usi



COOLEY
13.431.25
 16,5 cm

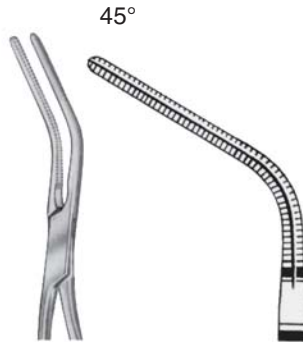

COOLEY
13.431.45
 16,5 cm

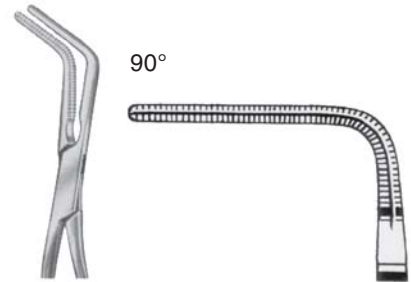

COOLEY
13.431.90
 16,5 cm

Anastomosenklemmen
 Anastomosis Clamps
 Pincas à anastomose
 Pinzas para anastomosis
 Pinze per anastomosi



COOLEY
13.433.14
 14,0 cm



COOLEY DERRA

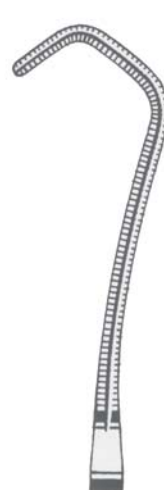

13.441.16
 16,0 cm



13.441.17
 17,0 cm

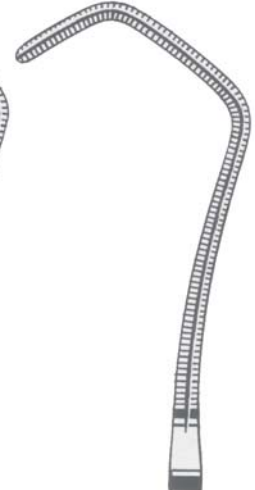

13.441.18
 18,0 cm

Atraumatische Gefäßklemmen
 Atraumatic Hemostatic Forceps
 Pincès hémostatiques atraumatiques
 Pinzas hemostáticas atraumáticas
 Pinze emostatiche atraumatiche

dimeda[®]

SURGICAL INSTRUMENTS

Anastomosenklemmen
 Anastomosis Clamps
 Pincès à anastomose
 Pinzas para anastomosis
 Pinze per anastomosi



COOLEY
 17,0 cm



13.447.17
 Fig. 1

13.449.17
 Fig. 2



COOLEY



13.451.16
 16,0 cm

13.453.16
 17,5 cm

13.455.17
 17,5 cm



COOLEY
13.457.17
17,0 cm



COOLEY
13.461.17
17,0 cm



COOLEY
13.465.18
18,0 cm



COOLEY
13.465.19
19,0 cm



COOLEY
13.465.26
26,0 cm



COOLEY
13.467.27
27,0 cm

Neonatal- und Kinderklemmen, extra feine Modelle
 Neonatal and Childrens Clamps, extra delicate patterns
 Pincès-clamps pour des nouveaux-nés et des enfants, modèles très fins
 Pinzas clamps para recién nacidos y niños, modelos muy finos
 Pinze pediatriche, modelli molto fini



CASTAÑEDA
13.481.13
 13,0 cm



CASTAÑEDA
 13,0 cm

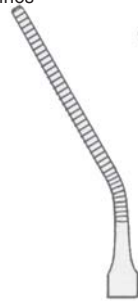

13.483.13
 Fig. 1
 13,0 cm

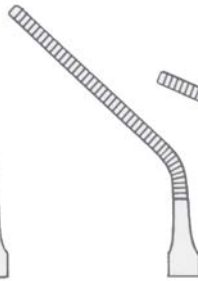

13.485.13
 Fig. 2
 13,0 cm

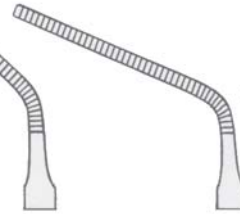

13.487.13
 Fig. 3
 13,0 cm



13.489.13
 Fig. 4
 13,0 cm



CASTAÑEDA
 12,0 cm

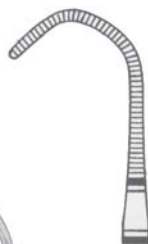

13.491.15
 Fig. 1
 12,0 cm

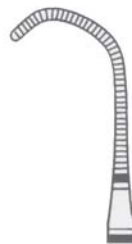

13.493.15
 Fig. 2
 12,0 cm



13.495.12
 Fig. 3
 12,0 cm



13.495.15
 Fig. 4
 12,0 cm

Kinder-Gefäßklemmen
 Pediatric Vascular Clamp
 Pincès vasculaires pédiatriques
 Pinzas vasculares pediátricas
 Pinze vascolari pediatriche



gerade
 straight
 droites
 rectas
 rette

13.502.01 - 13.502.09
 Fig. 1-9



abgewinkelt
 angled
 coudées
 acodadas
 angolari

13.503.01 - 13.503.09
 Fig. 1-9



stark abgewinkelt
 strongly angled
 fortement coudées
 fuertemente acodadas
 fortemente angolari

13.505.01 - 13.505.09
 Fig. 1-9



Fig. 1

13.502.01
13.503.01
13.505.01



Fig. 2

13.502.02
13.503.02
13.505.02



Fig. 3

13.502.03
13.503.03
13.505.03

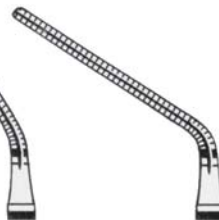

Fig. 4

13.502.04
13.503.04
13.505.04



Fig. 5

13.502.05
13.503.05
13.505.05



Fig. 6

13.502.06
13.503.06
13.505.06

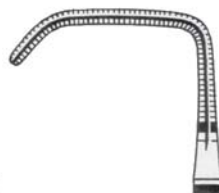

Fig. 7

13.502.07
13.503.07
13.505.07

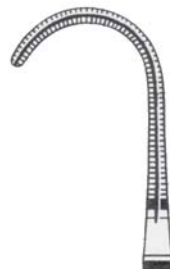

Fig. 8

13.502.08
13.503.08
13.505.08



Fig. 9

13.502.09
13.503.09
13.505.09

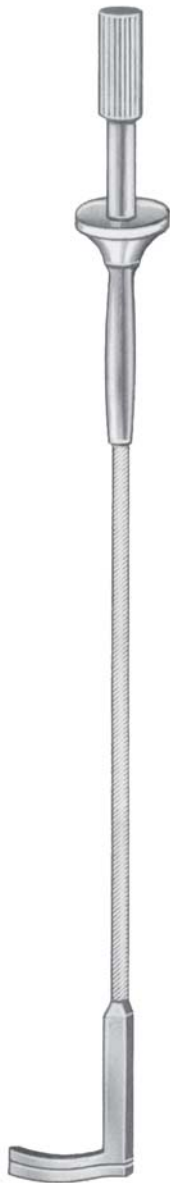

13.609.12 - 13.611.30
20,0 cm



13.609.12
12 mm



13.609.20
20 mm



13.609.30
30 mm

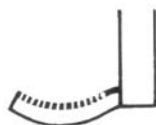

13.611.12
12 mm



13.611.20
20 mm



13.611.30
30 mm

Flexible Gefäßklemmen
Flexible Vessel Clamps
Pincès vasculaires flexibles
Pinzas vasculares flexibles
Pinze vascolari flessibili

dimeda[®]

SURGICAL INSTRUMENTS



13.615.03
ø 3 mm



13.615.05
ø 5 mm



13.615.07
ø 7 mm

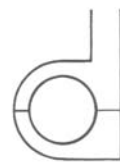

13.615.09
ø 9 mm

13.615.03 - 13.615.09

dimeda[®]

SURGICAL INSTRUMENTS