

68

Mastdarm

Rectum

Rectum

Recto

Retto

Mastdarm
Rectum
Rectum
Recto
Retto

dimeda[®]

SURGICAL INSTRUMENTS

Mastdarm-Spekula
Rectal Specula
Spéculums rectaux
Espécules rectales
Specoli rettai



SIMS
68.110.15
15 cm



BODENHAMMER
68.115.15
68.117.15 = Kaltlicht · Cold Light
15 cm
Lumière froide
Luz fría · Luce fredda

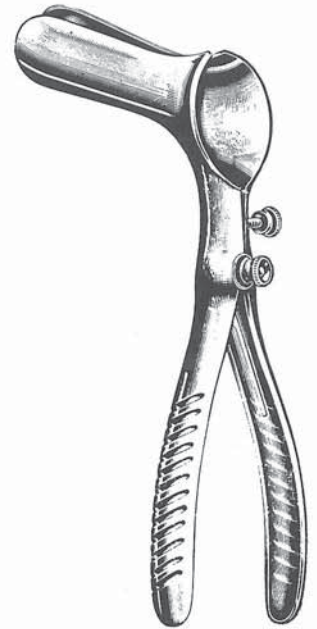

PRATT
68.121.00

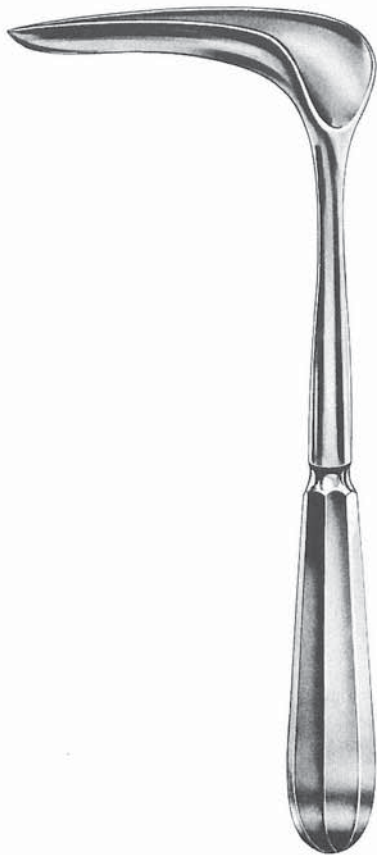

CZERNY
68.105.22
22 cm



BARR
68.125.17
70x22 mm
17 cm

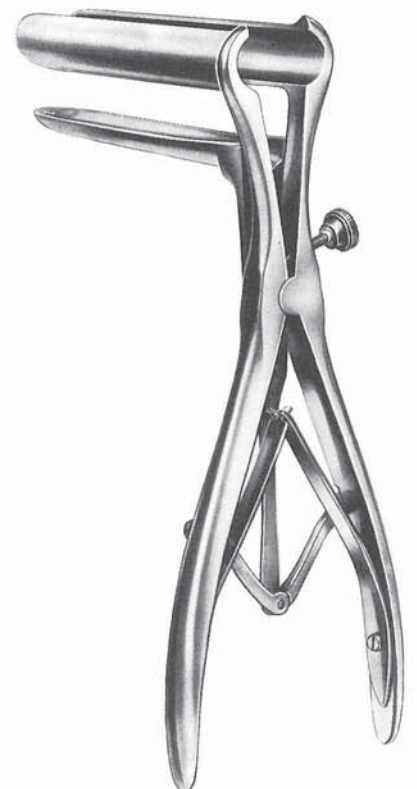

MATHIEU
68.130.19
19,5 cm

Mastdarm
 Rectum
 Rectum
 Recto
 Retto

dimeda[®]

SURGICAL INSTRUMENTS

Mastdarm-Spreizer
 Anal Retractors
 Dilatateurs p. anus et rectum
 Separadores rectales
 Dilatatori per l'ano e il retto

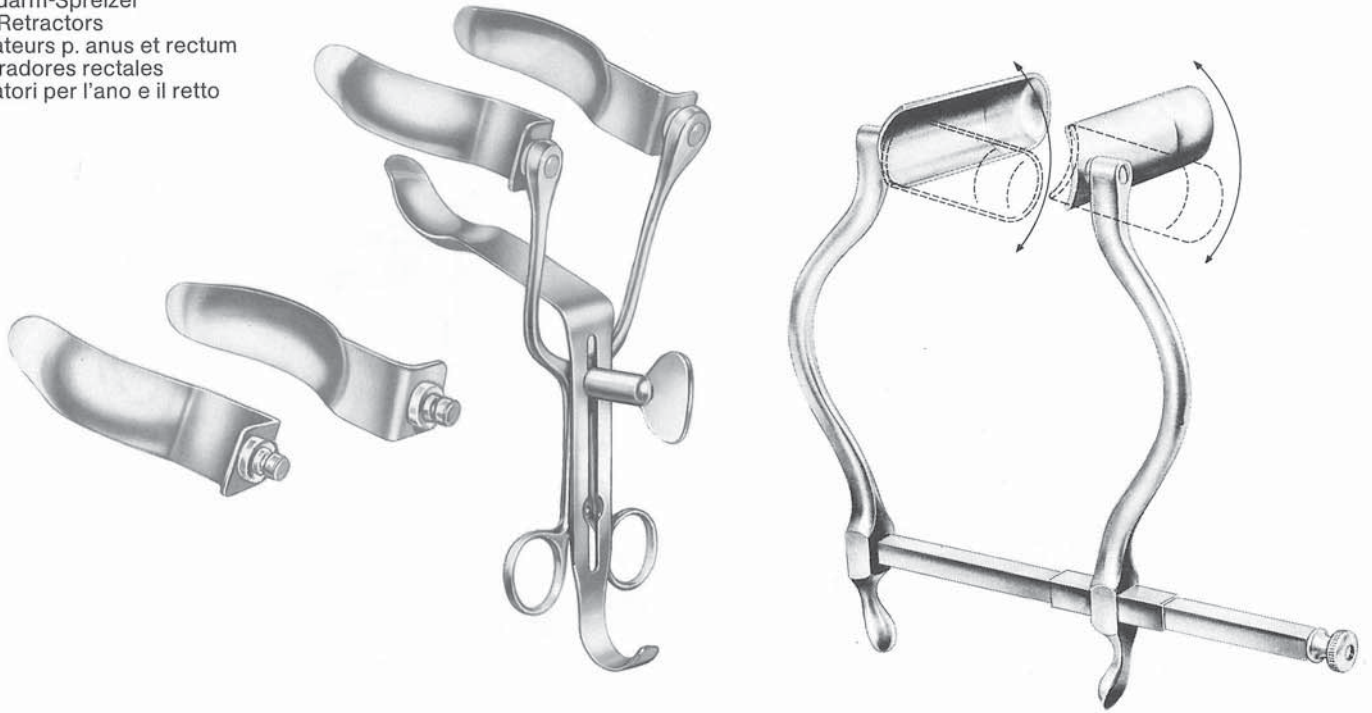

ALAN-PARKS
 68.147.00
 compl.
 13,5 cm

SMITH-BUIE
 68.150.15
 75x23 mm
 15 cm

68.148.00
 Kaltlicht-Adapter für 68.147.00
 Cold Light Attachment for 68.147.00
 Adaptateur lumière froide pour 68.147.00
 Adaptador luz fría para 68.147.00
 Adattatore luce fredda per 68.147.00

Rektoskop
 Rectoscope
 Rectoscope
 Rettoscopio
 Rettoscopio

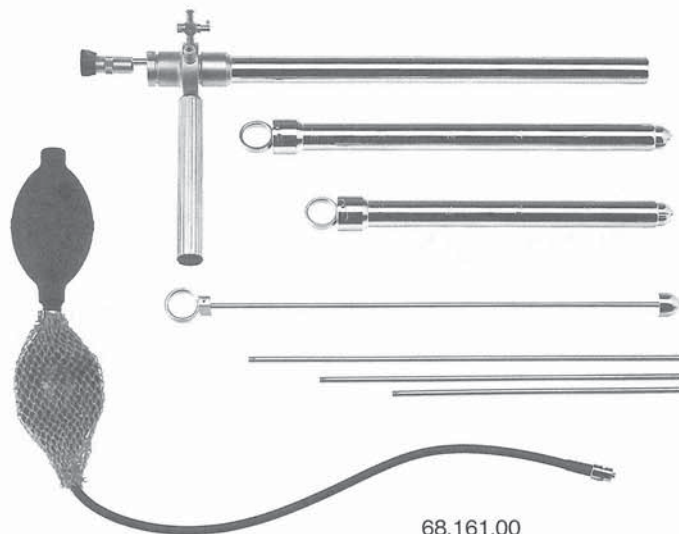

68.161.00
 compl.

Kaltlicht · Cold Light · Lumière froide
 Luz fría · Luce fredda

Anoskope, Proktoskope
Anoscopes, Proctoscopes
Anuscopes, Proctoscopes
Anoscopios, Proctoscopios
Anoscopi, Proctoscopi

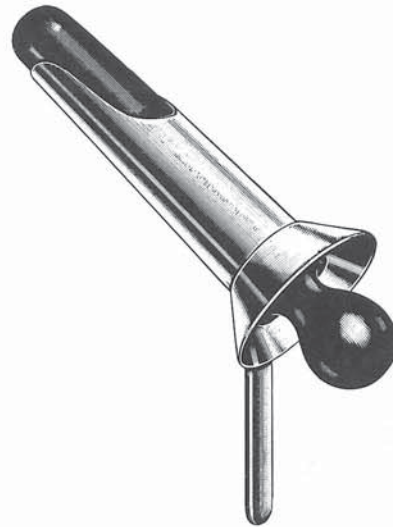

IVES-FANSLER
68.210.22
22 mm Ø
L = 80 mm



Ø mm	HIRSCHMANN
16	68.212.16
19	68.212.19
22	68.212.22
L = 65 mm	

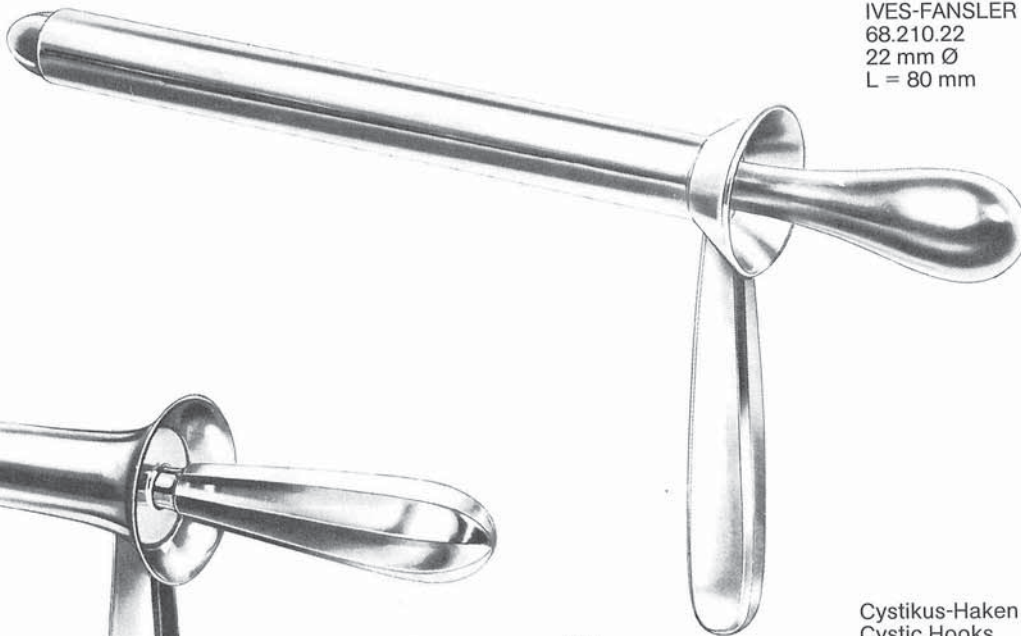

mm Ø x L	KELLY
22 x 50	68.220.05
22 x 100	68.220.10
22 x 140	68.220.14
22 x 200	68.220.20



Ø mm	KELLY
21	68.224.21
27	68.224.27
L = 50 mm	

Cystikus-Haken
Cystic Hooks
Ecarteurs rectaux
Ganchos rectales
Uncini rettali



68.251.01
Fig. 1

68.251.02
Fig. 2

68.251.03
Fig. 3

PRATT
68.251.01-68.251.03

Mastdarm
Rectum
Rectum
Recto
Retto

dimeda[®]

SURGICAL INSTRUMENTS



BUIE
68.261.41
41 cm

Biopsie-Zangen
Biopsy Specimen Forceps
Pinces emporte-pièce à biopsie
Pinzas sacabocado para biopsia
Pinze per biopsia

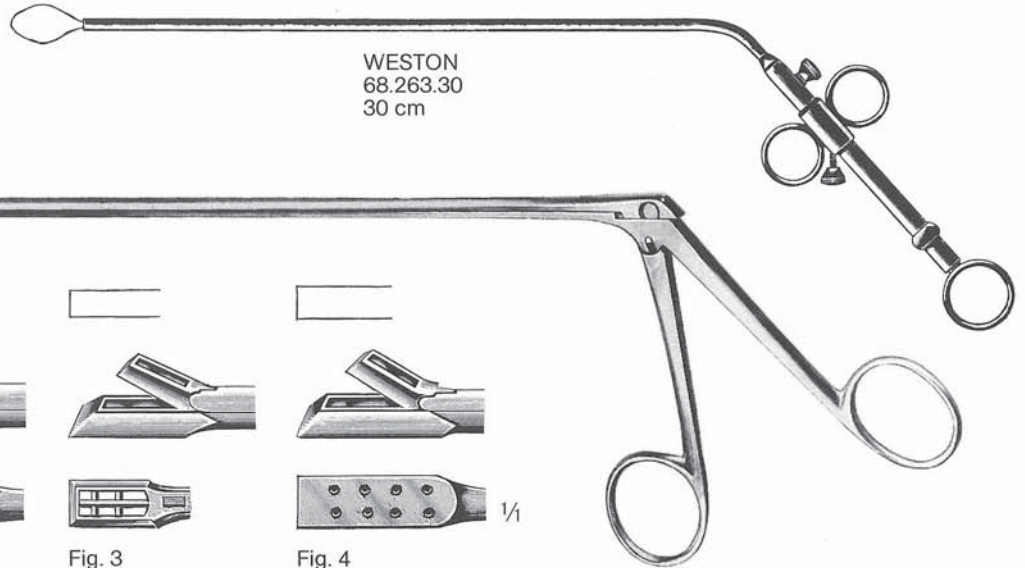

WESTON
68.263.30
30 cm

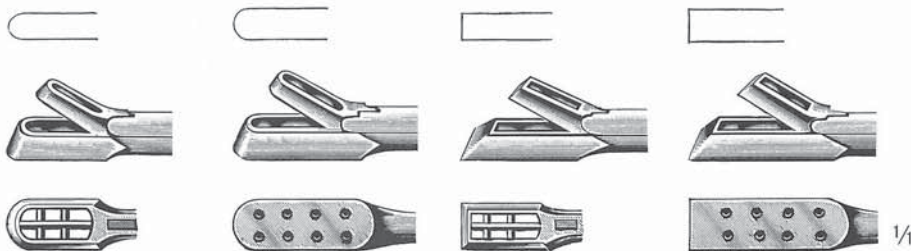

Fig. 1

Fig. 2

Fig. 3

Fig. 4

				cm	YEOMAN
68.301.28	68.302.28	68.303.28	68.304.28	28	
68.301.35	68.302.35	68.303.35	68.304.35	35	
68.301.42	68.302.42	68.303.42	68.304.42	42	

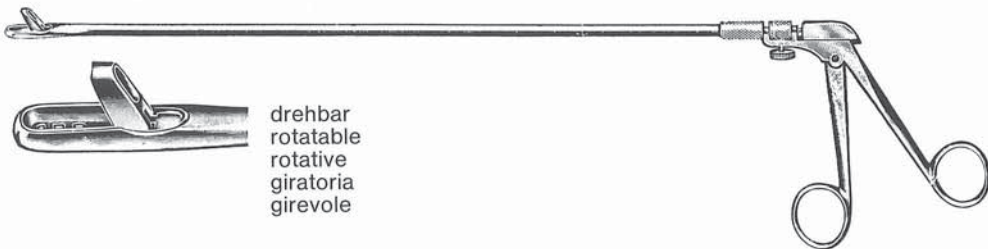

drehbar
rotatable
rotative
giratoria
girevole

cm	YEOMAN
23	68.311.23
33	68.311.33
40	68.311.40

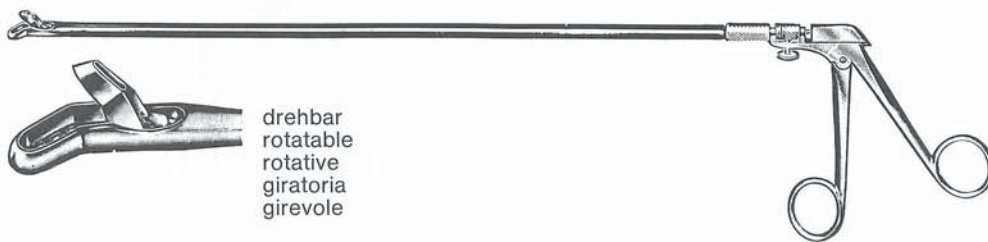

drehbar
rotatable
rotative
giratoria
girevole

cm	TUREL
23	68.321.23
33	68.321.33
40	68.321.40

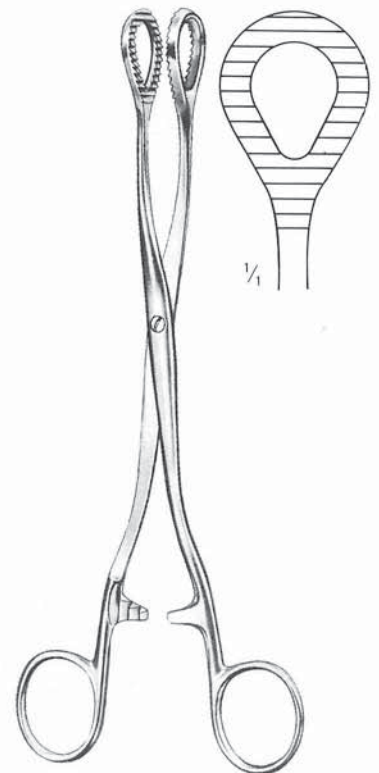

HEYWOOD-SMITH
68.402.21
21 cm

dimeda[®]

SURGICAL INSTRUMENTS